



**MACDONALD
HIGHLANDS**

DESIGN GUIDELINES

Prepared:.....September 1, 1992

Revision Dates:.....September 24, 1998
May 12, 1999
December 13, 1999
April 27, 2000
September 1, 2000
May 1, 2002
January 7, 2003
July 7, 2003
March 1, 2004
December 1, 2005
September 1, 2006

***** TO AVOID UNNECESSARY EXPENSE, PLEASE ADVISE
YOUR ARCHITECT TO SCHEDULE A MEETING WITH THE
DESIGN REVIEW COMMITTEE PRIOR TO PREPARATION
AND SUBMITTAL OF ARCHITECTURAL PLANS *****

TABLE OF CONTENTS

		<u>Page</u>
1.0	INTRODUCTION	
1.1	MACDONALD HIGHLANDS' <i>PHILOSOPHY</i>	1.1
1.2	DESIGN GUIDELINES	1.3
1.3	DESIGN REVIEW PROCESS	1.4
1.4	BUILDING ENVELOPE	1.6
1.5	DEFINITIONS	1.7
2.0	COMMUNITY DESIGN & DEVELOPMENT GUIDELINES	
2.1	DESIGN CONCEPT	2.1
2.2	LANDSCAPE THEME	2.2
2.3	STREETS & TRAIL SYSTEM	2.2
2.3.1	Stephanie Street	2.4
2.3.2	MacDonald Ranch Drive	2.5
2.3.3	Roma Hills Drive	2.6
2.3.4	Private Residential Collectors	2.6
2.3.5	Private Residential Streets	2.6
2.3.6	Private Residential Lanes	2.6
2.3.7	Bike and Pedestrian Trail System	2.7
2.4	PROJECT ENTRIES	2.7
2.5	SITE GRADING	2.10
2.6	DRAINAGE	2.12
2.7	PARKING	2.14
2.8	SETBACKS	2.15

2.9 LIGHTING..... 2.18

 2.9.1 Architectural Lighting..... 2.21

 2.9.2 Landscape Lighting..... 2.22

 2.9.3 Graphics 2.22

 2.9.4 Pedestrian Lighting 2.23

 2.9.5 Roadway Illumination..... 2.23

2.10 FENCES & WALLS..... 2.24

 2.10.1 Perimeter or Boundary Walls 2.26

 2.10.2 View Walls..... 2.28

 2.10.3 Retaining Walls..... 2.34

 2.10.4 Rear Yard Cone of Vision..... 2.36

 2.10.5 Security Walls 2.36

 2.10.6 Screening Walls..... 2.39

 2.10.7 Landscape Walls..... 2.39

 2.10.8 Windbreak Walls..... 2.39

 2.10.9 Interior Wall Conditions..... 2.40

2.11 FOUNDATIONS 2.40

2.12 UTILITIES..... 2.40

2.13 SERVICE AREAS..... 2.41

2.14 GOLF COURSE LOTS OR PARCELS 2.41

2.15 SWIMMING POOLS..... 2.42

2.16 TENNIS COURTS..... 2.42

2.17 LOT OR PARCEL RESTRICTIONS..... 2.43

2.18 SIGNAGE STANDARDS 2.44

 2.18.1 Introduction..... 2.44

 2.18.2 Theme/Materials 2.44

 2.18.3 Letter Style..... 2.45

 2.18.4 Primary Entry Monumentation 2.45

 2.18.5 Directional Signage..... 2.46

*2.33 -
Amalgamates*

2.18.6 Secondary Directional..... 2.46
 2.18.7 Street Signs 2.46
 2.18.8 Traffic/Regulatory Signs..... 2.46
 2.18.9 Temporary Project Development Signs..... 2.47

3.0 ARCHITECTURE GUIDELINES- CUSTOM HOMES

3.1 INTRODUCTION & GENERAL PRINCIPLES..... 3.1
 3.1.1 Architectural Theme: Desert Elegance Aesthetic..... 3.1
 3.1.2 Pool & Spa Criteria and Hardscape Setbacks 3.2
 3.1.3 Walls 3.2
 3.1.4 Service Areas & Utility Entrance Locations 3.3
 3.1.5 Easements 3.4
 3.1.6 Exterior Elevations..... 3.4

 3.2 DESIGN CRITERIA - CUSTOM HOMES..... 3.5
 Introduction 3.5

 3.3 SITE PLANNING CRITERIA – CUSTOM HOMES 3.8
 Introduction..... 3.8
 3.3.1 Building Envelope 3.8
 3.3.1.a Combined Lots 3.9
 Table Minimum Setbacks 3.10
 3.3.2 Natural Area..... 3.11
 3.3.3 Private Area 3.14
 3.3.4 Building Orientation 3.14
 3.3.4.a Solar Orientation..... 3.14
 3.3.4.b View Orientation..... 3.15
 3.3.4.c Relationship to Adjacent Lots & The Overall
 Community 3.16
 3.3.5 Driveway and Parking Criteria..... 3.21
 3.3.5.a Driveway Location..... 3.21
 3.3.5.b Maximum Width of Driveways 3.21
 3.3.5.c Minimum Length of Driveways..... 3.22
 3.3.5.d Driveway Setback from Side Property Lines..... 3.22
 3.3.5.e Driveway Materials..... 3.22
 3.3.5.f Garage Placement 3.22
 3.3.5.g Parking Spaces Required 3.22
 3.3.5.h Repair of Damages..... 3.23

3.3.6	Site Amenity Standards.....	3.23
3.3.6.a	Accessory Structures.....	3.23
3.3.6.b	Swimming Pools.....	3.24
3.3.6.c	Tennis Courts.....	3.25
3.3.6.d	Sports Courts.....	3.26
3.3.6.e	Exterior Recreational or Play Equipment and Pool Slides.....	3.26
3.3.6.f	Basketball Hoops.....	3.27
3.3.6.g	Address Identification.....	3.28
3.3.6.h	Exterior Lighting.....	3.29
3.3.6.i	Exterior Holiday Decorations.....	3.32
3.3.7	Hillside Design Criteria.....	3.33
3.3.7.a	Neighborhood-Level Criteria.....	3.33
3.3.7.b	Custom Lot Criteria.....	3.37
Table	Roadway Standards.....	3.38
3.3.7.c	Lot Grading and Drainage.....	3.41
3.3.7.d	Retaining Walls.....	3.44
3.3.7.e	Driveways.....	3.47
3.3.7.f	Hillside Architecture.....	3.49
3.3.7.g	View Preservation.....	3.57
3.4	ARCHITECTURAL DESIGN CRITERIA—CUSTOM HOMES.....	3.60
3.4.1	Architectural Character.....	3.60
3.4.2	Floor Areas [Table].....	3.61
3.4.3	Architectural Components.....	3.62
3.4.4	Building Facades.....	3.62
3.4.4.a	Building Massing and Scale.....	3.63
3.4.4.b	Building Height.....	3.64
3.4.4.c	Hillside Lots with Slopes Exceeding 5%.....	3.64
3.4.4.d	Sloping Height Limit.....	3.64
3.4.4.e	Reversed Sloping Height Limit.....	3.65
3.4.4.f	Lots With Slopes Less Than 5%.....	3.66
3.4.4.g	Massing.....	3.67
3.4.4.h	Articulation.....	3.67
3.4.4.i	Exposed Wall Heights.....	3.71
3.4.5	Exterior Materials.....	3.73
3.4.6	Color Overview.....	3.74
3.4.7	Color Program.....	3.75

3.4.8	Color Palette Design Kit	3.76
3.4.9	Builder Color Requirements	3.77
3.4.9.a	Color Scheme Number.....	3.77
3.4.9.b	Roof Colors.....	3.77
3.4.9.c	Building Colors.....	3.77
3.4.9.d	Masonry	3.78
3.4.9.e	Color Plotting.....	3.78
3.4.10	Custom Color Requirements.....	3.78
3.4.10.a	Roof Colors.....	3.78
3.4.10.b	Building Colors.....	3.78
3.4.11	Color Submittals	3.79
3.4.12	Roof Design	3.87
3.4.12.a	Roof Form and Slope.....	3.87
3.4.12.b	Roof Materials and Colors.....	3.89
3.4.12.c	Mechanical Equipment Screening	3.91
3.4.13	Architectural Features and Accents	3.92
3.4.13.a	Entry Courtyards	3.92
3.4.13.b	Walkways, Balconies, Terraces and Patios.....	3.93
3.4.13.c	Windows	3.96
3.4.13.d	Screen Walls	3.97
3.4.13.e	Garage / Auto Courts	3.98
3.4.13.f	Parking	3.99
3.4.13.g	Chimneys	3.99
3.4.13.h	Building Projections.....	3.100
3.4.13.i	Accessory Structures.....	3.100
3.4.13.j	Flagpoles.....	3.101
3.4.13.k	Service Areas	3.101
3.4.13.l	Utility Equipment.....	3.101
3.4.13.m	Unique Exterior Features	3.102
3.4.13.n	Materials	3.103
3.4.13.o	Exterior Storage	3.103
3.4.13.p	Antennas/Satellite Dishes	3.104
3.4.13.q	Solar Application	3.104
3.4.13.r	Foundations.....	3.104
3.4.13.s	Additional Construction and/or Exterior Changes...	3.104
3.4.13.t	Mailboxes.....	3.105
3.4.13.u	Security	3.107

4.A.0 SITE PLANNING CRITERIA – ATTACHED HOUSING

4.A.1.1 Introduction..... 4A.1

4.A.1.2 Building Envelope 4A.1

4.A.1.3 Building Orientation 4A.1

 4.A.1.3.a View Orientation..... 4A.2

 Table 19.3.4.1 Residential District Intensity &
 Dimensional Standards (City of Henderson) 4A.3

 4.A.1.3.b Relationship to Adjacent Lots & the Overall
 Community 4A.4

4.A.1.4 Parking and Driveway Criteria..... 4A.5

 4.A.1.4.a Location..... 4A.5

 4.A.1.4.b Materials..... 4A.5

 4.A.1.4.c Garage Placement..... 4A.5

 4.A.1.4.d Parking Spaces Required..... 4A.5

 4.A.1.4.e Repair of Damages 4A.5

4.A.1.5 Site Amenities..... 4A.6

 4.A.1.5.a Swimming Pools, Spas & Hardscape Setbacks..... 4A.6

 4.A.1.5.b Tennis Courts 4A.6

 4.A.1.5.c Sports Courts 4A.7

 4.A.1.5.d Exterior Recreational or Play Equipment and
 Pool Slides 4A.7

 4.A.1.5.e Exterior Lighting 4A.7

4.A.1.6 Hillside Design Criteria 4A.9

4.A.1.7 Parcel Grading and Drainage 4A.10

4.A.1.8 Retaining Walls..... 4A.12

4.A.1.9 Vehicular Circulation..... 4A.13

4.A.1.10 Roadway Standards [Table] 4A.14

4.A.1.11 Water (Public Works) 4A.15

4.A.1.12 Water (Fire Department)..... 4A.15

 4.A.1.12.a Water System Flow 4A.15

 4.A.1.12.b Building Fire Sprinkler Systems..... 4A.15

 4.A.1.12.c Water Main Sizes 4A.16

 4.A.1.12.d Fire Hydrant Branch Lines 4A.16

 4.A.1.12.e Fire Hydrant Location and Distribution 4A.16

4.A.1.13 Wastewater Collection and Treatment..... 4A.17

4.A.1.14 Homeowners Association 4A.17

4.A.1.15 Hillside Architecture..... 4A.18

4.A.1.16 View Preservation..... 4A.19

4.A.2	ARCHITECTURAL DESIGN CRITERIA–ATTACHED HOUSING	4A.20
4.A.2.1	Architectural Character	4A.20
4.A.2.2	Architectural Components	4A.21
4.A.2.3	Building Facades.....	4A.22
4.A.2.4	Building Massing and Scale.....	4A.22
	4.A.2.4.a Building Height.....	4A.22
	4.A.2.4.b Massing	4A.23
	4.A.2.4.c Articulation.....	4A.23
4.A.2.5	Exterior Materials	4A.24
4.A.2.6	Color Overview.....	4A.26
4.A.2.7	Color Program.....	4A.27
4.A.2.8	Color Palette Design Kit	4A.28
4.A.2.9	Builder Color Requirements	4A.29
	4.A.2.9.a Color Scheme Number.....	4A.29
	4.A.2.9.b Roof Colors	4A.29
	4.A.2.9.c Building Colors	4A.29
	4.A.2.9.d Masonry	4A.29
	4.A.2.9.e Color Plotting.....	4A.30
4.A.2.10	Color Submittals	4A.30
4.A.2.11	Roof Design	4A.30
	4.A.2.11.a Roof Form and Slope	4A.31
4.A.2.12	Roof Materials and Colors	4A.33
	4.A.2.12.a Permitted Roof Materials	4A.33
	4.A.2.12.b Prohibited Roof Materials	4A.33
	4.A.2.13.c Mechanical Equipment Screening.....	4A.34
4.A.2.13	Architectural Features and Accents	4A.34
	4.A.2.13.a Entries.....	4A.34
	4.A.2.13.b Walkways, Balconies, Terraces & Patio Structures.....	4A.35
	4.A.2.13.c Windows.....	4A.36
	4.A.2.13.d Columns and Archways.....	4A.36
	4.A.2.13.e Chimneys.....	4A.36
	4.A.2.13.f Building Projections	4A.37
	4.A.2.13.g Garage Doors.....	4A.37
	4.A.2.13.h Accessory Structures	4A.38
	4.A.2.13.i Screen Walls.....	4A.39
	4.A.2.13.j Service Areas.....	4A.39

4.A.2.13.k	Utility Equipment	4A.39
4.A.2.13.l	Unique Exterior Features.....	4A.40
4.A.2.13.m	Materials	4A.40
4.A.2.13.n	Antennas/Satellite Dishes.....	4A.41
4.A.2.13.o	Solar Application.....	4A.41
4.A.2.13.p	Foundations	4A.41
4.A.2.13.q	Additional Construction, Revisions, Modifications, and/or Exterior Changes.....	4A.41
4.B.0	SITE PLANNING CRITERIA—DETACHED PRODUCTION HOMES	
4.B.1	INTRODUCTION & GENERAL PRINCIPLES	4B.42
4.B.1.1	Architectural Theme: Desert Elegance Aesthetic.....	4B.42
4.B.1.2	Pool & Spa Criteria and Hardscape Setbacks	4B.43
4.B.1.3	Walls	4B.43
4.B.1.4	Service Areas & Utility Entrance Locations.....	4B.43
4.B.1.5	Easements	4B.44
4.B.1.6	Exterior Elevations.....	4B.45
4.B.2	DESIGN CRITERIA – DETACHED PRODUCTION HOMES	4B.45
	Introduction	4B.45
4.B.3	SITE PLANNING CRITERIA–DETACHED PRODUCTION HOMES.	4B.47
	Introduction.....	4B.47
4.B.3.1	Building Envelope	4B.48
4.B.3.2	Building Orientation	4B.48
	4.B.3.2.a View Orientation.....	4B.48
	Table Minimum Setbacks	4B.49
	4.B.3.2.b Relationship to Adjacent Lots & The Overall Community	4B.50
4.B.3.3	Driveway and Parking Criteria.....	4B.50
	4.B.3.3.a Driveway Location.....	4B.50
	4.B.3.3.b Driveway Materials.....	4B.50
	4.B.3.3.c Parking Spaces Required	4B.50
	4.B.3.3.d Repair of Damages.....	4B.51
4.B.3.4	Site Amenity Standards.....	4B.51
	4.B.3.4.a Accessory Structures.....	4B.51
	4.B.3.4.b Swimming Pools	4B.51
	4.B.3.4.c Exterior Recreational or Play Equipment and Pool Slides	4B.52

4.B.3.4.d	Basketball Hoops	4B.52
4.B.3.4.e	Address Identification	4B.52
4.B.3.4.f	Exterior Lighting	4B.54
4.B.3.4.g	Exterior Holiday Decorations	4B.56
4.B.3.5	Design Criteria	4B.57
4.B.3.5.a	Water (Public Works)	4B.57
Table	Production Homes Roadway Standards	4B.60
4.B.3.5.b	Production Lot Criteria [Table]	4B.61
4.B.3.5.c	Lot Grading and Drainage.....	4B.62
4.B.4	ARCHITECTURAL DESIGN CRITERIA— DETACHED PRODUCTION HOMES	4B.64
4.B.4.1	Architectural Character	4B.64
4.B.4.2	Floor Areas [Table].....	4B.65
4.B.4.3	Architectural Components	4B.65
4.B.4.4	Building Facades.....	4B.66
4.B.4.4.a	Building Massing and Scale.....	4B.66
4.B.4.4.b	Massing.....	4B.67
4.B.4.4.c	Articulation	4B.67
4.B.4.5	Exterior Materials	4B.68
4.B.4.6	Color Overview.....	4B.69
4.B.4.7	Color Program.....	4B.69
4.B.4.8	Color Palette Design Kit	4B.70
4.B.4.9	Production Color Requirements.....	4B.71
4.B.4.9.a	Roof Colors.....	4B.71
4.B.4.9.b	Building Colors.....	4B.71
4.B.4.9.c	Color Plotting.....	4B.71
4.B.4.10	Color Submittals	4B.72
4.B.4.11	Roof Design	4B.78
4.B.4.11.a	Roof Form and Slope.....	4B.78
4.B.4.11.b	Roof Materials and Colors	4B.81
4.B.4.11.c	Mechanical Equipment Screening	4B.82
4.B.4.12	Architectural Features and Accents	4B.83
4.B.4.12.a	Entry Courtyards	4B.83
4.B.4.12.b	Walkways, Balconies, Terraces and Patios.....	4B.86
4.B.4.12.c	Windows	4B.87
4.B.4.12.d	Screen Walls	4B.87
4.B.4.12.e	Garage / Auto Courts	4B.88
4.B.4.12.f	Parking	4B.89

4.B.4.12.g Chimneys	4B.89
4.B.4.12.h Building Projections.....	4B.90
4.B.4.12.i Accessory Structures.....	4B.90
4.B.4.12.j Flagpoles	4B.90
4.B.4.12.k Service Areas	4B.91
4.B.4.12.l Utility Equipment.....	4B.91
4.B.4.12.m Materials	4B.91
4.B.4.12.n Exterior Storage	4B.92
4.B.4.12.o Antennas/Satellite Dishes	4B.92
4.B.4.12.p Solar Application	4B.92
4.B.4.12.q Foundations.....	4B.92
4.B.4.12.r Additional Construction, Revisions, Modifications and/or Exterior Changes.....	4B.93
4.B.4.12.s Mailboxes.....	4B.93
4.B.4.12.t Security	4B.93
4.C.0 LANDSCAPE CRITERIA—ATTACHED & DETACHED HOUSING	4C.94
4.C.1 Landscape Design Concept.....	4C.94
4.C.2 Landscape Zones.....	4C.94
4.C.3 Landscape Installation & Maintenance.....	4C.95
5.0 LANDSCAPE DESIGN GUIDELINES	
5.1 LANDSCAPE DESIGN CONCEPT	5.1
5.2 LANDSCAPE ZONES	5.2
5.2.1 Desert Oasis Zone	5.2
5.2.2 Enhanced Desert Zone	5.2
5.2.3 Natural Desert Zone	5.3
5.3 STREETSCAPE	5.3
5.4 LANDSCAPE COVERAGE	5.9
5.5 PARKING LOT OR PARCEL LANDSCAPING	5.10
5.6 ENTRIES	5.11
5.7 RESIDENTIAL LANDSCAPING.....	5.11
5.7.1 Custom Residential Lots	5.12

5.8 COMMERCIAL AREA..... 5.15

5.9 GOLF COURSE/CLUBHOUSE 5.17

5.10 LANDSCAPE INSTALLATION & MAINTENANCE 5.18

 5.10.a Rear Yard Cone of Vision / Dedicated View Corridors 5.20

6.0 DESIGN REVIEW PROCEDURES

6.1 CUSTOM LOT PROCEDURES 6.1

 6.1.1 Submission of Plans 6.1

 6.1.2 Review of Plans 6.1

 6.1.3 Pre-Design Conference 6.2

 6.1.4 Forms 6.3

 6.1.5 Schematic Plan Review..... 6.3

 6.1.6 Final Plan Review 6.7

 6.1.7 Revisions..... 6.8

 6.1.8 Resubmittal of Plans 6.9

 6.1.9 Working Drawings and Construction Specifications..... 6.9

 6.1.10 Work in Progress..... 6.10

 6.1.11 Completed Work..... 6.11

 6.1.12 Right of Waiver..... 6.12

 6.1.13 Commencement of Construction 6.12

 6.1.14 Design Review Committee Fees 6.12

6.2 MERCHANT-BUILT RESIDENTIAL DEVELOPMENT PROCEDURES... 6.15

 6.2.1 Submission of Plans..... 6.15

 6.2.2 Review of Plans 6.15

 6.2.3 Pre-Design Conference 6.16

 6.2.4 Concept Plan Review 6.17

 6.2.5 Grading Plan Review 6.20

 6.2.6 Tentative Map Review 6.21

 6.2.7 Final Map Review 6.23

 6.2.8 Improvement Plan Review..... 6.24

 6.2.9 Revisions..... 6.24

 6.2.10 Resubmittal of Plans 6.24

 6.2.11 Working Drawings and Construction Specifications..... 6.25

 6.2.12 Work in Progress..... 6.26

6.2.13	Completed Work.....	6.26
6.2.14	Right of Waiver.....	6.27
6.2.15	Commencement of Construction	6.27
6.2.16	Design Review Committee Fees	6.27
6.3	PROCEDURES FOR COMMERCIAL & RESORT DEVELOPMENTS	6.30
6.3.1	Submission of Plans.....	6.30
6.3.2	Review of Plans	6.30
6.3.3	Pre-Design Conference	6.31
6.3.4	Preliminary Site Plan Review	6.32
6.3.5	Grading Plan Review	6.36
6.3.6	Tentative Commercial Subdivision Map Review	6.37
6.3.7	Final Site Plan Review.....	6.37
6.3.8	Final Commercial Subdivision Map Review.....	6.41
6.3.9	Improvement Plan Review.....	6.41
6.3.10	Revisions.....	6.41
6.3.11	Resubmittal of Plans	6.42
6.3.12	Working Drawings and Construction Specifications.....	6.42
6.3.13	Work in Progress.....	6.43
6.3.14	Completed Work.....	6.43
6.3.15	Right of Waiver.....	6.44
6.3.16	Commencement of Construction	6.44
6.3.17	Design Review Committee Fees	6.44
6.4	DESIGN REVIEW COMMITTEE.....	6.47
6.4.1	Appointment of Members	6.47
6.4.2	Resignation of Members	6.48
6.4.3	Duties	6.48
6.4.4	Meetings.....	6.48
6.4.5	Design Review Architectural Representation.....	6.49
6.4.6	Compensation	6.49
6.4.7	Amendment of Design Guidelines.....	6.50
6.4.8	Non-Liability.....	6.51
6.4.9	Non-Liability of the Design Review Committee & Declarant	6.51
6.4.10	Enforcement.....	6.52
6.6.11	Severability	6.52

6.5 CONSTRUCTION CONTROL..... 6.53

6.5.1 Pre-Construction Conference 6.53

6.5.2 Construction Conditions 6.53

6.5.3 Commencement of Construction 6.54

6.5.4 Inspection of Work In Progress..... 6.55

6.5.5 Temporary Construction Fencing 6.56

6.5.6 Subsequent Changes 6.57

6.5.7 Final Inspection of Improvements 6.57

6.5.8 Occupational Safety and Health Act (OSHA) Compliance 6.58

6.5.9 Construction Trailers, Portable Field Offices, Etc..... 6.59

6.5.10 Storage Containers 6.59

6.5.11 Debris and Trash Removal..... 6.59

6.5.12 Sanitary Facilities..... 6.61

6.5.13 Vehicles and Parking Areas 6.61

6.5.14 Staging Areas 6.61

6.5.15 Conservation of Landscaping Materials..... 6.62

6.5.16 Excavation Materials 6.62

6.5.17 Blasting 6.63

6.5.18 Restoration or Repair of Other Property Damaged..... 6.63

6.5.19 Miscellaneous and General Practices..... 6.63

6.5.20 Construction Area Plan..... 6.65

6.5.21 Construction Access..... 6.66

6.5.22 Dust and Noise..... 6.66

6.5.23 Signage..... 6.67

6.5.24 Daily Operation..... 6.67

6.5.25 Enforcement..... 6.68

7.0 HILLSIDE DEVELOPMENT GUIDELINES

7.1 INTRODUCTION..... 7.1

7.2 PURPOSE..... 7.1

7.3 DEFINITIONS 7.1

7.4 HILLSIDE CLASSIFICATION TYPES..... 7.3

7.4.1 Hillsides 7.3

7.4.2 Steep Hillside..... 7.3

7.4.3 Mountainous 7.3

7.4.4 Rugged Mountain..... 7.3

7.5 HILLSIDE DEVELOPMENT STANDARDS 7.4

 7.5.1 Design Standards 7.4

 7.5.2 Site Standards..... 7.4

 7.5.3 Streets, Driveways, and Drainage 7.5

7.6 HILLSIDE DEVELOPMENT APPLICATION 7.8

 7.6.1 Hillside Development Plan 7.8

 7.6.2 Hillside Development Reports..... 7.8

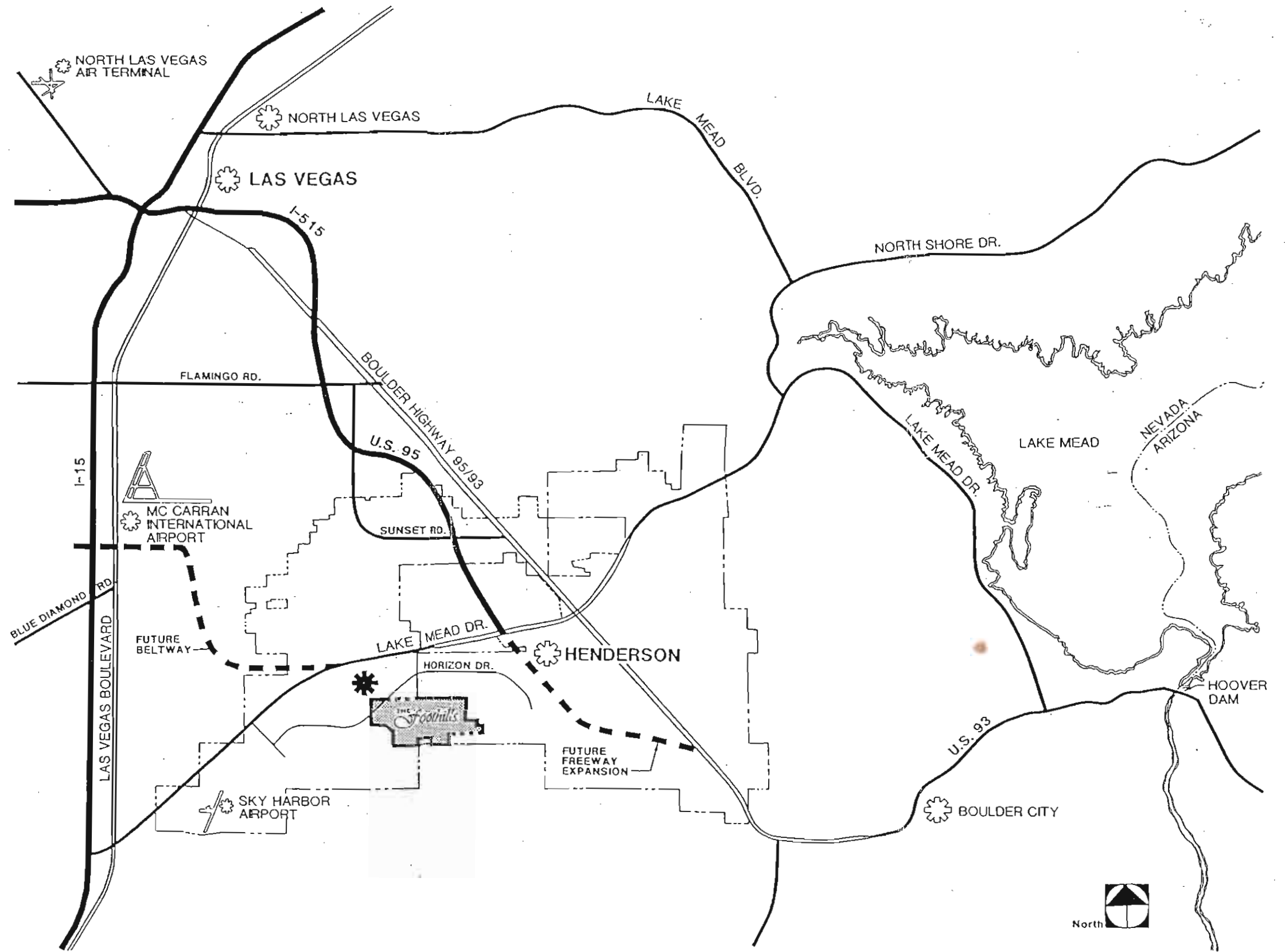

REGIONAL MAP

THE *Foothills*
AT MACDONALD RANCH

EXHIBIT INDEX

Exhibit “a” Regional Map..... xv

Exhibit “A” Foothills at MacDonald Ranch Site Plan 1.16

Exhibit “B” Circulation Map – Trails..... 2.3

Exhibit “C” Stephanie St. & MacDonald Ranch Drive 2.8

Exhibit “D” MacDonald Ranch Drive – Private Street..... 2.9

Exhibit “E” Residential Off Street Parking One Residence 2.16

Exhibit “F” Residential Off Street Parking Two Residences 2.17

Exhibit “G” Landscape Uplighting of Trees 2.20

Exhibit “H” Block Wall 2.27

Exhibit “I” View Wall 2.29

Exhibit “J” View Fence 2.30

Exhibit “K” Sloping View Fence..... 2.31

Exhibit “L” Community Design Wrought Iron Paint Color 2.33

Exhibit “M” Planter Wall 2.35

Exhibit “N” Rear Yard Cone of Vision..... 2.37

Exhibit “O” Rear Yard Cone of Vision Lot Designations 2.38

Exhibit “P” Street Signage at Intersection..... 2.48

Exhibit “Q” Street Signage Detail..... 2.49

Exhibit “R” Custom Homes – Natural Area 3.12

Exhibit “S” Residential Illustrative Site Plan 3.13

Exhibit “T” Custom Homes – Solar Orientation 3.18

Exhibit “U” Custom Home – View Orientation 3.19

Exhibit “V” Custom Home – Lot Cross Sections 3.20

Exhibit “W” Custom Home – Escarpment Grading 3.45

Exhibit “X” Custom Home – Grading 3.46

Exhibit “Y” Custom Home – Retaining Walls 3.48

Exhibit “Z” Custom Home – Lot Criteria – Sloping Site –
Terraced Floor Levels 3.51

Exhibit “aa” Custom Home – Lot Criteria – Sloping Site –
Single Floor Level..... 3.52

Exhibit “ab” Custom Home – Lot Criteria – Ridge or Knoll –
Terraced Floor Level..... 3.53

Exhibit “ac” Custom Home – Lot Criteria – Ridge or Knoll –
Single Floor Level..... 3.54

Exhibit “ad” Custom Home – Lot Criteria – Low Center –
Terraced Floor Levels 3.55

Exhibit “ae” Custom Home – Lot Criteria – Low Center –
Single Floor Level..... 3.56

Exhibit “af” Custom Home – Lot Criteria – View Preservation 3.58

Exhibit “ag” Custom Home – Lot Criteria – View Preservation 3.59

Exhibit “ah” Custom Home – Slope Criteria 3.68

Exhibit “ai” Custom Home—Reversed Slope Height Criteria 3.69

Exhibit “aj” Custom Home – Massing..... 3.70

Exhibit “ak” Custom Home – Horizontal Character..... 3.72

Exhibit “al” Field Color Use 3.81

Exhibit “am” Architectural Color Palette 3.82

Exhibit “an” Color Application Strategy 3.86

Exhibit “ao” Custom Home – Roof 3.90

Exhibit “ap” Custom Home – Entry..... 3.94

Exhibit “aq” Custom Home – Court Yard 3.95

Exhibit “ar” Mailbox Type & Location Site Map 3.108

Exhibit “as” Building Facades—Massing 4A.25

Exhibit “at” Architectural Color Palette 4B.73

Exhibit “au” Color Application Strategy 4B.77

Exhibit “av” Detached Production Homes – Roofs 4B.80

Exhibit “aw” Detached Production Homes – Courtyards 4B.84

Exhibit “ax” Detached Production Homes – Courtyards 4B.85

Exhibit “ay” Enhanced Desert Along Roadway & Fitness Path 5.4

Exhibit “az” “Desert Oasis” Along Roadway & Fitness Path 5.5

Exhibit “ba” Natural Desert Zone (Re-vegetated) 5.6

Section 6: Exhibit A—Application for Schematic Plan Review i
Schematic Plan Review Checklist

Exhibit B—Application for Final Plan Review ii
Final Plan Review Checklist

Exhibit C—Application for Project Completion Reviewiii
Application for an Alteration and/or Modification to
an Existing Structure or Lot iv

1.0 INTRODUCTION

1.1 MACDONALD HIGHLANDS

PHILOSOPHY

MacDonald Highlands is situated in a majestic mountain valley featuring a backdrop of rugged mountain peaks as well as spectacular city light views. The master plan for MacDonald Highlands is committed to the preservation of the site's inherent natural beauty, thus ensuring that the mountainous desert character of the site will always be symbolic of the community's identity. Because of this commitment, MacDonald Highlands will soon take its place as the crown jewel of southern Nevada master-planned communities.

A dedication to the preservation of nature's beauty, enhanced by the highest aesthetic standards of landscape design, MacDonald Highlands will set the stage for an uncompromising standard of residential living. Years of effort by a team of outstanding land planners, architects, and engineers will provide a project of enduring quality. Additionally, to protect and enhance owner value, a strict set of covenants and guidelines will be carefully monitored by a professionally advised design review committee.

The fundamental community concept of MacDonald Highlands is to preserve the natural character of the desert environment, particularly the rugged hillside areas. The residential neighborhoods are designed such that site development will blend harmoniously into the natural desert setting, creating a rural atmosphere of casual country estates. This design includes reducing the design speed of all of the site roadways to 20 M.P.H., thus allowing such roadways to conform to the natural contour and setting of the hillside environment. The community identity is

further enhanced by an 18-hole championship golf course and destination resort. The golf course fairways meander throughout the neighborhoods within MacDonald Highlands, with many of the individual homesites featuring direct frontage on the course. In addition, significant view corridors to the golf course are provided at key locations along the community street system.

Because each development within MacDonald Highlands will be unique in terms of its natural opportunities and constraints, it is expected that the design of each development be tailored to preserve, enhance, and protect those special features of each individual Lot or Parcel. Each development project must consider those approaches in design and construction, which will accentuate those unique attributes while preserving the natural features of each Lot or Parcel. The design of each Lot or Parcel within the MacDonald Highlands community shall support the overall philosophy of the community by carefully integrating the development into the topography.

Design standards and restrictions and a Design Review Committee have been developed to implement and enforce this philosophy. Minimum standards of design arising out of the environmental and climatic needs of the desert provide direction to Lot or Parcel owners and developers in the planning, design, and construction of their residences or projects to insure compatibility with the environment, harmonious architectural approaches, and compatibility with adjacent development within the community. The Design Review Committee will encourage creativity, innovative use of materials and design, and unique methods of construction so long as the final result is consistent with these Design Guidelines and the overall philosophy of MacDonald Highlands. No one residence, structure, improvement, or development should stand apart in its design or construction so as to detract from the overall environment and appearance of MacDonald Highlands.

The design and architectural standards and restrictions as set forth in these Design Guidelines should be viewed by each Owner as his assurance that the special environment of MacDonald Highlands will be preserved and enhanced over time.

1.2 DESIGN GUIDELINES

The purpose of these Supplemental Design Guidelines is to provide specific direction for the expression of the built environment within the Custom Home neighborhoods of MacDonald Highlands. They are intended to provide an overall framework for future development, achieving a sense of neighborhood identity, land use character, scale and sensitivity to the desert environment in the development of MacDonald Highlands' neighborhoods.

The purpose of these Design Guidelines is to implement the community design theme by addressing the architectural, landscape, and site planning design criteria for the development of MacDonald Highlands. These Guidelines are intended to set standards for the quality of design, to assure land use compatibility, to direct character and form, and to enhance the community's overall value. The Guidelines are intended first as an information source to Owner's builders, developers, architects, or investors interested in MacDonald Highlands; and second, as a regulatory mechanism to insure that all Improvements in the community are carried out in an environmentally sensitive manner. These Guidelines will thus insure a high standard of project-wide design consistency throughout the life of the community.

MacDonald Highlands Design Guidelines are intended to be a conceptual, dynamic guide to development and, as such, are subject to change when the Design Review Committee determines such

change is in the best interests of the community. In addition, the graphic illustrations in this document are intended to convey a concept, and not to portray specific plans for construction. **EACH OWNER IS RESPONSIBLE FOR OBTAINING FROM THE DESIGN REVIEW COMMITTEE A COPY OF THE MOST RECENT DESIGN GUIDELINES BEFORE COMMENCING ON ANY IMPROVEMENTS TO THE OWNER'S LOT.**

These design standards are binding on any persons, company, or firm, which intends to construct, reconstruct, or modify any permanent or temporary Improvements in MacDonald Highlands community or in any way alter the natural setting of the desert environment.

Accompanying the Design Guidelines are Covenants, Conditions, and Restrictions (CC&Rs), which have been formally adopted and recorded to establish the Community Association and the Association Rules and Regulations, while guaranteeing long-term maintenance of all common facilities within the community. In the event of a conflict between the CC&Rs and the Design Guidelines, the CC&Rs will prevail.

1.3 DESIGN REVIEW PROCESS

In order to assist each Owner in the planning and design of the Residence, or Non-Residential Parcel and in the understanding of the unique opportunities of each particular Lot or Parcel, a comprehensive design review committee and process has been established pursuant to these Design Guidelines. The process provides an opportunity for the Owner to draw upon the expertise and knowledge, which has been acquired during the planning and development of MacDonald Highlands. Since the preservation and enhancement of the unique natural landscape of MacDonald Highlands are important principles, the Design Review Committee

is charged with the responsibility of insuring that these principles are carried out in all phases of development. It is encouraged that the designs are a result of the uniqueness of the site and are not transplanted designs.

The design review process was developed to provide adequate checkpoints along the way, so that time and money are not wasted on plans and designs, which do not adhere to the Design Guidelines or to the overall principles of MacDonald Highlands. Every attempt has been made to streamline this review process to eliminate excessive time delays. Nevertheless, each Owner is personally responsible for strictly complying with the Design Guidelines, and all other applicable provisions of the Declaration or rules and regulations of any governmental authority, in order to bring the design review process to a speedy and satisfactory conclusion.

It is necessary that the Owner(s) retains competent professional services for planning and design. *The Design Review Committee must approve all architects.* A thorough analysis and understanding of a particular Lot or Parcel and the Owner's special needs and living patterns, as well as the ability to convey to the Design Review Committee, through drawings and a model, the concept and design of the proposed Residence or other Improvement, are all important elements of the design review process. An Owner may not elect to do his own design or to retain non-professional services.

In general, the design review process is divided into four phases. The first phase includes a pre-design meeting(s) to permit each Owner to review his ideas and the natural aspects of his particular Lot or Parcel with a representative of the Design Review Committee before any plans are prepared. The second phase provides for the review of conceptual or preliminary plans by the conformance with the Design Guidelines. The third phase, the

final design review, insures that the final plans and construction drawings are consistent with the previously approved preliminary plans and the Design Guidelines. The final phase includes an inspection by a representative(s) of the Design Review Committee to determine whether actual construction has been completed in strict compliance with the approved plans and the Design Guidelines.

Approval of plans and specifications by the Design Review Committee is not, and should not be deemed to be, a representation or warranty that said plans and specifications comply with applicable governmental ordinance or regulations including, without limitation, City of Henderson zoning ordinances, subdivision regulation, and building codes.

1.4 BUILDING ENVELOPE

Within the Hillside Buildable Areas, the concept of a maximum allowable building area, called the Building Envelope, has been developed to ensure the preservation of views from each residence in MacDonald Highlands.

All Improvements on a Lot or Parcel within MacDonald Highlands must be designed to be within this Building Envelope, including the Residence, accessory buildings, outside patios and terraces, tennis courts and swimming pools, if permitted by the Design Guidelines, and any other Improvements or structures on the Lot or Parcel. Only approved plants may be planted within the Building Envelope, unless otherwise approved by the Design Review Committee. Outside of the Building Envelope, the natural desert must be undisturbed or revegetated with complementary desert plant material where possible. Moreover, it is not intended that the Owner design his Residence or other Improvements so as to completely fill the Building Envelope. Designs, which, in the

opinion of the Design Review Committee, overwhelm the Building Envelope and are, therefore, inconsistent with the philosophy of MacDonald Highlands, will not be approved.

Before any conceptual planning is done, an Owner should consult with the Design Review Committee to determine the location of the Building Envelope. Although the shape and location of the Building Envelopes are intended to be somewhat flexible, modifications to the Building Envelope can be made only by the Design Review Committee and only if the modifications do not result in a significant adverse impact upon the natural features of the Lot or Parcel, or upon neighboring Lots or Parcels, or the Project as a whole.

After the final design approval has been given by the Design Review Committee, a revised Building Envelope will be based on actual plans, which may differ in size and shape from the original conceptual Building Envelope. Thereafter, the Building Envelope may be changed only through an amendment process after obtaining the approval of the Design Review Committee. This process assures that the view corridor of the Building Envelope will be permanently protected from any future encroachment or development.

1.5 DEFINITIONS

The following words, phrases, or terms used in this Declaration shall have the following meanings:

"Apartment Development" shall mean a Parcel or portion thereof which is described in a Parcel Declaration, is limited by the Declaration to residential use, and contains Rental Apartments and surrounding area which are intended, as shown by the site plan therefor approved by the City of Henderson, and the Design Review Committee or otherwise, as one integrated apartment operation under the same ownership.

"**Architect**" means a person appropriately licensed to practice architecture or landscape architecture in the State of Nevada.

"**Association**" shall mean the non-profit corporation to be organized by Declarant to administer and enforce the Covenants and to exercise the rights, powers, and duties set forth in this Declaration, its successors and assigns. Declarant hereby reserves the exclusive right to cause such Association to be incorporated and intends to name the Association "MacDonald Highlands Master Association," and hereby reserves the right to use any similar name if, for any legal or other reason, "MacDonald Highlands Master Association" cannot or should not be used.

"**Association Rules**" shall mean the rules for MacDonald Highlands adopted by the Board.

"**Builder**" means a person or entity engaged by an Owner for the purpose of constructing any Improvement within MacDonald Highlands. The Builder and Owner may be the same person or entity.

"**City**" shall mean the City of Henderson, Nevada.

"**Clubhouse Parcel**" shall mean the Clubhouse Parcel as shown on the Master Development Plan for MacDonald Highlands and/or described in a recorded Parcel Declaration. The Clubhouse Parcel shall be privately owned and may be operated in conjunction with the Golf Course. The Clubhouse Parcel shall not be transferable to the Association pursuant to the CC&Rs. The number of Memberships attributable to the Clubhouse Parcel shall be determined by the applicable Parcel Declaration.

"**Cluster Residential Development**" shall mean a Parcel subdivided into Lots with dwelling units intended for Single Family occupancy and may include those types of residential housing arrangements known as townhouses, clustered housing, "clubdominiums," zero-lot line housing, and similar arrangements, together with related areas intended for the use and enjoyment of the Owners and Residents of the Lots in the Cluster Development.

"**Commercial/Office Development**" shall mean a Lot or Parcel limited by a Parcel Declaration to be used for commercial and/or office use or related use as approved by the City of Henderson and the Design Review Committee and within the restrictions created by the Covenants.

"**Common Area and Common Areas**" shall mean (a) all Association Land and the improvements thereon; (b) all land within MacDonald Highlands which the Declarant, by this Declaration or other recorded instrument, makes available for use by Members of the Association and evidences its intent to convey to the Association at a later date; (c) all land within MacDonald Highlands, which the Declarant indicates on a recorded subdivision plat or Parcel Declaration is to be used for landscaping, water retention, drainage, and/or flood control for the benefit of MacDonald Highlands and/or the general public and is to be dedicated to the public or the City of Henderson upon the expiration of a fixed period of time, but only until such land is so dedicated; and (d) areas on a Lot, Parcel, or Golf Course within easements granted to the Association or its Members for the location, construction, maintenance, repair, and replacement of a wall, fence, sidewalk, landscaping, utility access, or other uses, which easement may be granted or created on a recorded subdivision plat or Parcel Declaration or by a Deed or other conveyance accepted by the Association, and all land within MacDonald Highlands, which is owned privately or by a

governmental agency for which the Association has accepted responsibility for maintenance, and for which the Association benefits by limited use, full use, or aesthetic consistency, for the benefit of the Members.

"Condominium Development" shall mean a horizontal property regime established under the laws of the State of Nevada, which is limited by the Parcel Declaration therefor to residential use.

"Condominium Unit" shall mean an apartment or condominium unit, together with any appurtenant interest in all general and common elements, which is created by a horizontal property regime established under Nevada law. Such term shall not include a Rental Apartment in an Apartment Development.

"Covenants" shall mean the covenants, conditions, restrictions, assessments, charges, servitudes, liens, reservations, and easements set forth herein.

"Declarant" shall mean The Foothills Partners, a Nevada limited partnership, or any successor, successor-in-title or assign who takes title to any portion of the property for the purpose of development and/or sale and who is designated as the Declarant in a recorded instrument executed by the immediately preceding Declarant. If there is ever more than one Declarant, the rights and privileges of the Declarant shall be exercised by the Person designated from time to time by all the Declarants in a written instrument recorded in the Official Records of the County Recorder, otherwise by those Persons owning two-thirds of the potential Units.

"Declaration" shall mean this Declaration of Covenants, Conditions, Restrictions, Assessments, Charges, Servitudes, Liens, Reservations, and Easements, as amended or supplemented from time to time.

"**Design Guidelines**" means the restrictions, review procedures, and construction regulations adopted and enforced by the Design Review Committee as set forth herein and as amended from time to time by the Design Review Committee.

"**Design Review Committee**" shall mean the committee of the Association to be created pursuant to the CC&Rs to perform the functions of an Architectural Design Review Committee.

"**Dwelling Unit**" shall mean any building or portion of a building situated upon a Lot or Parcel designed and intended for use and occupancy as a residence by a Single Family, but shall exclude any model home until such model home has been sold or leased as a residence of a Single Family.

"**General Commercial and/or Office Development**" shall mean a Parcel limited by a Parcel Declaration to be used for various commercial and/or office purposes within the restrictions created by the Covenants.

"**Golf Course**" and "**Golf Course Land**" shall mean the Golf Course real property and all improvements thereon (excluding the clubhouse and associated recreational and other facilities located on the Clubhouse Parcel) as shown on the Master Development Plan for MacDonald Highlands.

IT SHOULD BE NOTED THAT A REUSE WATER ALLOCATION NECESSARY FOR THE WATERING OF THE GOLF COURSE HAS BEEN OBTAINED.

"**Golf Course Lot**" shall mean a residential Lot which has a portion of its boundary immediately adjacent to the Golf Course, or a Condominium or Cluster Residential Development which has a portion of its common elements immediately adjacent to the Golf Course.

"**Hillside Residential**" shall mean those residential projects within the Hillside Buildable areas.

"**Improvement**" shall mean all structures and appurtenances thereto of every type and kind, including but not limited to buildings, outbuildings, walkways, trails, tennis courts, sprinkler pipes, garages, swimming pools, spas, and other recreational facilities, the paint on all surfaces, carports, roads, driveways, parking areas, fences, screening walls, retaining walls, stairs, decks, landscaping, hedges, windbreaks, plantings, planted trees and shrubs, poles, signs, exterior air conditioning, and water softener fixtures or equipment.

"**Landscape Easement Area**" shall mean the approximate foot portion of land adjacent to the public rights-of-way in MacDonald Highlands and the entryways to MacDonald Highlands, which is subject to an easement for landscaping, sidewalks, perimeter walls, and utility access as described in the CC&Rs.

"**MacDonald Highlands**" (also known as The Foothills at MacDonald Ranch and MacDonald Ranch Country Club) shall mean the real property described on Exhibit "A" attached to this Declaration, together with any additional real property, which may from time to time become subject to and covered by this Declaration, and the development to be completed thereon.

"**Master Development Plan**" shall mean MacDonald Highlands, also known as The Foothills at MacDonald Ranch and MacDonald Ranch Country Club, approved by the City of Henderson, Nevada, and described on Exhibit "A", as the same may be from time to time amended, a copy of which shall be on file at all times in the office of the Association.

"**Owner**" shall mean (when so capitalized) the record holder of legal title to the fee simple interest in any Lot or Parcel including contract sellers, but excluding others who hold such title merely as security. In that case of Lots or Parcels, the fee simple title to which is vented of record in a trustee pursuant Nevada Revised Statutes, legal title shall be deemed to be in the Trustor. An Owner shall include any person who holds record title to a Lot or Parcel in joint ownership with any other person or holds an undivided fee interest in any Lot or Parcel.

"**Parcel**" or "**Parcel Description**" shall mean an area of real property within MacDonald Highlands limited to one of the following Land Use Classifications: Apartment Development, Condominium Development (but only until the horizontal property regime therefor is recorded), Shopping Center, Commercial Office, General Commercial, Resort Hotel, Casino, School, Church, Library, Fire Station, Golf Course, Commercial Recreational, Power Substation, or other use determined to be suitable by Declarant in accordance with the CC&Rs. The term parcel shall also include an area of land with MacDonald Highlands as to which a Parcel Declaration has been recorded designating the area for Single Family Residential Use or Cluster Residential Use but which has not yet been subdivided into Lots and related amenities and rights-of-way, but any such area shall cease to be a Parcel upon the recording of a subdivision plat or other instrument covering the area and creating Lots and related amenities. A Parcel shall not include a Lot, or any Exempt Property, but, in the case of staged

developments, shall include areas not yet included in a subdivision plat, horizontal property regime, or other recorded instrument creating Lots and related amenities.

"Resident" shall mean:

1. Each Owner under a contract of sale covering any part of the Assessable Property, regardless of whether the contract is recorded, and each Tenant actually residing or conducting a business on any part of the Assessable Property; and
2. Members of the immediate family of each Owner and of each buyer and Tenant referred to in subparagraph (1) actually living in the same household with such Owner or Tenant.

Subject to such rules and regulations as the Association may hereafter specify (including the imposition of special non-resident fees for use of the Association Land if the Association shall so direct), the term "Resident" also shall include the Guests of invitees of any such Owner, or Tenant, if and to the extent the Board in its absolute discretion by resolution so directs.

"Single Family" shall mean a group of one or more persons each related to the other by blood, marriage, or legal adoption, or a group of not more than three (3) persons not all so related, who maintain a common household in a Dwelling Unit.

"Single Family Residential Development" shall mean a Parcel limited by a Parcel Declaration for use as a development of Single Family detached housing, each intended for use by a Single Family, and subject to restrictions contained in the Parcel Declaration recorded for any such specific development, and which shall be subject to the restrictions defined in the CC&Rs, and the entire Covenants as applicable.

"Streets" shall mean those areas of MacDonald Highlands, which are depicted as "Private Street" or "Public Street" or on any subdivision map recorded and filed by Declarant, or on any Master Development Plan.

"Visible From Neighboring Property" shall mean, with respect to any given object, that such object is or would be visible to a person six feet tall, standing at ground level on any part of such neighboring property.

2.0 COMMUNITY DESIGN & DEVELOPMENT GUIDELINES

2.1 DESIGN CONCEPT

The site planning criteria is meant to be utilized as a means to create a strong neighborhood fabric offering a visually appealing environment in and around the community.

MacDonald Highlands is envisioned as a unique community with amenities and activities designed to provide a living environment for a select number of residents. The residential areas will blend into the site's natural surroundings.

The focal point of the community is a private 18-hole golf course and country club, which creates a superlative backdrop for the community's residential component. The luxury resort will become an additional amenity for residents and act as a focus on social interaction in the community. The amenities offered within the private, gated community that is MacDonald Highlands create a lifestyle of incomparable luxury for full-time residents and the destination resort guests.

All of the residences will be designed to be consistent with the Desert Elegance theme of architecture. The Golf Course will be allowed to create its own individual identity and character more reflective of a Desert Elegance theme of architecture.

The hillsides of the MacDonald Highlands project are an invaluable resource. All construction and improvements shall be carefully planned to blend with the contour of the land. Most hillside lots offer unparalleled views of the entire Las Vegas valley.

In addition to the recreational amenities already described, bicycling and jogging paths will run along MacDonald Ranch Drive and provide an additional recreational attraction for the community.

2.2 LANDSCAPE THEME

MacDonald Highlands' landscape theme is based on a natural desert oasis concept. Through the development and implementation of its landscape program, MacDonald Highlands will introduce the desert oasis theme to the mountain coves and the undulating terrain of the community. Section 5.0 of these Development Guidelines addresses the specific landscape design concepts, criteria, and zones.

Great care will be taken to preserve the rock outcroppings and steep hillsides serving as a backdrop for the community.

2.3 STREETS & TRAIL SYSTEM

The hierarchy of roadways within the MacDonald Highlands community is designed to complement the overall quality of the MacDonald Highlands development. All roadways will be private. Access to the community will be from public roads such as Horizon Ridge Parkway and Stephanie Street through the project entry gates.

The roadways are to be designed to extend the overall community desert oasis theme throughout the community with the use of the project streetscape design concepts. Roadways are to conform as closely to natural grade as possible while maintaining compliance with the design parameters of the Henderson Hillside Ordinance.

Due to the nature of certain areas of the site, alternatives to horizontal alignments, cul-de-sacs, and roadway lengths may be modified with the approval of the City of Henderson City Council.

To minimize grading in the hillside areas, private driveways may be constructed from the roadway to serve one or more residences. Private driveways shall be constructed of concrete to avoid erosion onto the collector road. Gravel driveways are prohibited.

Designing streets and driveways in steep terrain must take into account several very important issues. Of primary importance is the ability to design a system that has the least impact on the native desert landscape. Sometimes this may require deviating from standard design procedures that are applicable to flatter areas. Minimizing pavement widths, while still providing adequate public health, safety, and welfare becomes a critical issue. In areas where guardrails will be required, public safety as well as architectural appeal must be considered. All proposed guardrail designs shall be approved by City staff. Special design considerations such as one-way streets and different ways of handling on-street parking are also important.

The street lighting systems must be carefully designed to prevent over-illumination of the hillside and to minimize visual impact from these systems. Lighting systems shall be designed to focus light downward as individual "pools of light," rather than dispersing it.

The maximum allowable grades for roadways must be considered in terms of driver comfort level as well as safety considerations. Fire trucks must be able to safely negotiate all proposed roads.

2.3.1 Stephanie Street is the major arterial serving the golf course and also acts as a primary entry for MacDonald Highlands. MacDonald Highlands is accessed by way of a 100- and 80-foot wide right-of-way from Lake Mead Drive,

to the MacDonald Highlands project boundary. Public access along Stephanie Street will extend into the project to the gated entry to the MacDonald Highlands private residential community. From the gated entry, Stephanie Street will continue south as a private collector boulevard to its intersection with MacDonald Ranch Drive. The median and property immediately adjacent to Stephanie Street from the gated entry to the intersection of MacDonald Ranch Drive will be landscaped using the Desert Oasis Zone intensity and plant materials palette with groups of palms being placed at areas of intersections, hilltops, or swales. The balance of the roadway will utilize mesquites, Palo Verdes and other desert foliage.

2.3.2 MacDonald Ranch Drive (formerly known as Foothills Village Drive), a private loop maintained by the MacDonald Highlands Master Association, will contain the project's major circulation. Gated for security and privacy, entries to this internal loop will be from Stephanie Street and Horizon Ridge Parkway. At the Horizon Ridge Parkway intersection, public access will extend several hundred feet inside the project, with adequate provisions for stacking and turnarounds. All residential development will accommodate emergency access while minimizing cut and fill areas to the other hillside development areas. The right-of-way width for MacDonald Ranch Drive will vary from 64 feet in the flatter terrain to 40 feet in the steeper hillside areas. Similarly, the landscaping zones for the medians, right-of-way, and property immediately adjacent to MacDonald Ranch Drive will vary from the Desert Oasis Zone in the flatter areas to the Enhanced Desert Zone in the steeper hillside areas. The southern portion of this

green belt area will contain a meandering jogging/cycling path, which will provide an opportunity for pedestrian and recreational pursuits.

2.3.3 Roma Hills Drive borders the Northwest property line of MacDonald Highlands. No direct access is provided to the community from this street, however, fire access is provided through the linear park, which divides Highlands Unit II and Planning Area 4 (also known as “Stonehaven”).

2.3.4 Private Residential Collectors: The right-of-way widths for the private residential collector streets within the MacDonald Highlands community will vary depending on the topography and number of residences being served by the residential collector. On-street parking is prohibited on the private roads and streets within the MacDonald Highlands community. Many streets and roads will have turnouts, which allow emergency parking.

2.3.5 Private Residential Streets: Most residential roads within MacDonald Highlands will contain 24-foot paved surfaces and all prohibit on-street parking. The primary reason for this width is to preserve the hillside by eliminating the unnecessary disturbance of existing topography. Some roadways will serve smaller numbers of homes and thus may require smaller widths and one-way directions. Lengths of cul-de-sacs will conform to City of Henderson Hillside criteria.

2.3.6 Private Residential Lanes: Some roadways or lanes will serve smaller numbers of homes and thus may require smaller widths and one-way directions.

2.3.7 Bike and Pedestrian Trail System: MacDonald Highlands will have a private bike, trail, and park system for the use of its residents. The trail system will run along MacDonald Ranch Drive and along Stephanie Street, winding through canyons and connecting to the private parks within the community. The minimum width of the trail system easement will be 6-feet and the maximum will be 8'.

2.4 PROJECT ENTRIES

Project entries at Stephanie Street and Horizon Ridge Parkway will reflect the desert oasis theme and will make a statement of the special quality of what lies within. The oasis theme of the community will be evidenced at these entries by the stately palms, mountain springs rushing over volcanic boulders, and the lush fullness of the desert flowers and vegetation.

MacDonald Highlands' project entry program for all subdivisions and Parcels provides an integrated design of landscaping, monumentation, and signage, which maintains compatibility with the surrounding environment and is intended to impart a subtle and tasteful introduction to the overall community. A major aspect of life at MacDonald Highlands is the creation of a safe and secure living environment. A sophisticated security system, supported by a central guard gate, professional security guards, and perimeter walls will provide the ultimate protection and privacy for residents and their guests.

Special attention will be given to hardscape and landscape treatments as well as signage and lighting of all project entries to enhance the overall image of the MacDonald Highlands community.

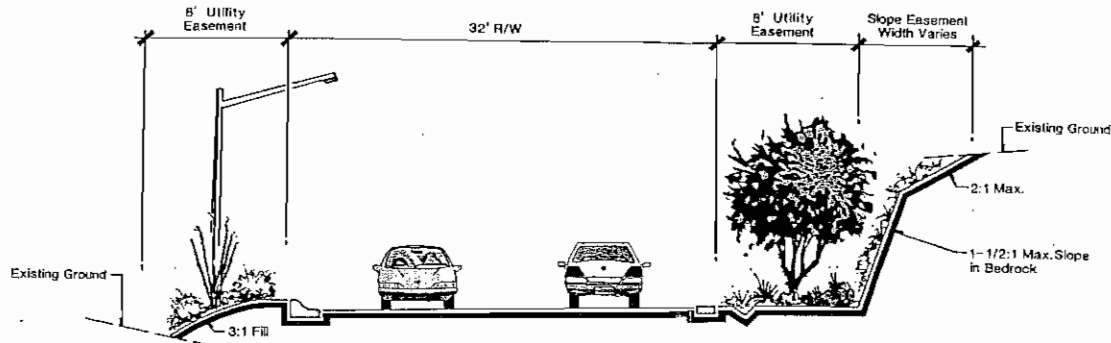

Section – Typical Residential Street – Private Street

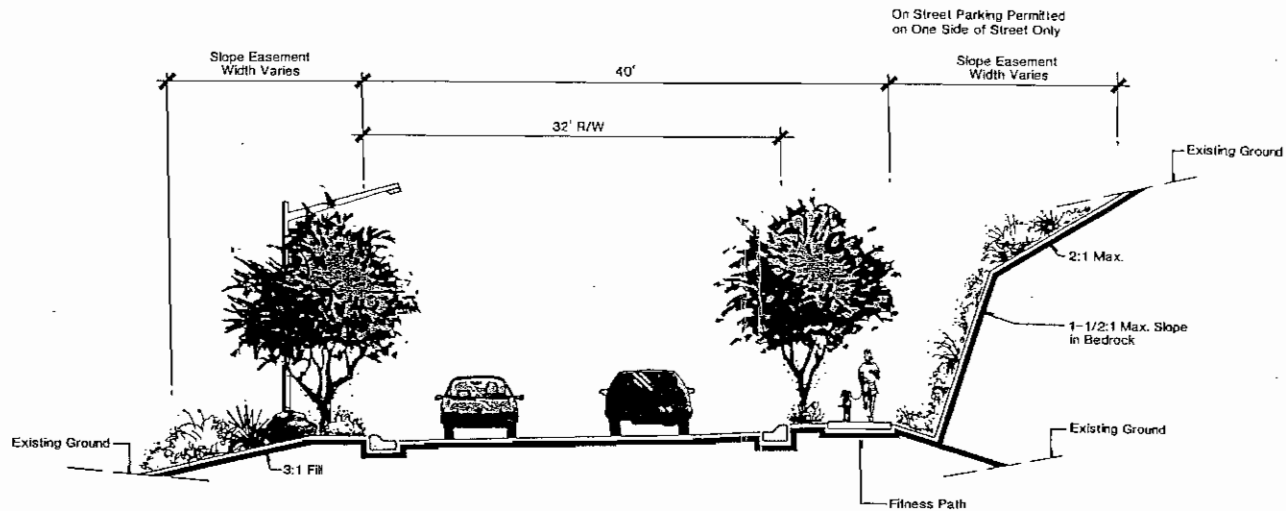

Section – MacDonald Ranch Dr. (Sta. 25+75 – Sta.65+60) – Private Street

Individual project entry areas will provide the resident and visitor with an overview of each project and will act to link the overall community design concepts together from project to project. Each project entry will be a continuation of the theme established by the main entries, only on a lesser scale.

Entries into residential neighborhoods and non-residential use areas occur at various locations throughout the community. These secondary entries consist of defined areas and may include such features as monumentation, signage, native and introduced vegetation, and enriched paving features.

Individuality for each of the neighborhood entries is also encouraged, but should remain within the overall guidelines established for signage and monumentation. Landscaping should enhance and compliment the design with colorful, drought-tolerant plant materials that are consistent with the appropriate plant palette.

2.5 SITE GRADING

The MacDonald Highlands project is situated on the northern slope of the McCullough Mountain range in Henderson, Nevada. Natural grades range from 3% in the northern portions of the project to 30% in the southern portions of the project. The main concept of this master-planned hillside community has been to preserve the natural characteristics of the hillside areas. In order to accomplish this, it is necessary for the community design concept to adopt grading criteria which limits the amount of discretionary grading that can be done in the hillside areas. In the development phase of the project, grading in the hillside areas will be limited to only that grading which is necessary to be able to construct the roadways, drainage facilities, and utilities necessary to serve and protect the planned hillside residences.

One objective of these development standards is to keep the necessary site development grading to a minimum in order to reduce impacts on the surroundings and to establish compatible relationships between buildings, landscape areas, and adjacent properties.

Any grading and all associated disturbances of the natural desert done for the purpose of constructing an individual residence on a lot or for the purpose of making improvements to an existing residence will be confined within the area designated as the "Building Envelope" for that particular lot.

Detailed grading plans prepared by a Nevada registered Civil Engineer will be required of every development in the MacDonald Highlands community. These grading plans will be reviewed by the Design Review Committee for compliance with MacDonald Highlands' Community Design Standards. No grading will be allowed within the MacDonald Highlands project without the review and approval of the Design Review Committee. In addition, City of Henderson permits are required per City regulations.

Where grading results in a disturbance of the existing desert surface, landscaping and resurfacing techniques will be used to restore a natural desert appearance to those areas or to create a new appearance which is compatible with, blends with, or enhances the natural desert appearance. Chemical treatment techniques such as "Permeon" and other forms of reestablishing a surface similar to the natural desert varnish are methods that can be used to treat disturbed areas. Other methods can include rock placement, landscaping, retaining walls, or a combination of the above for the purpose of reestablishing or enhancing the natural desert appearance. In the event that retaining walls are necessary to secure a slope only DRC-approved materials may be used.

Any grading should result in the re-contouring of land that reflects the natural landforms. Smooth, gradual transitions are encouraged where graded slopes meet natural terrain. Grading and siting techniques should respect natural drainage features, surface, and subsurface geological factors. In areas where large amounts of earthwork are unavoidable, the land should be reshaped with natural contours to provide a finished appearance, which duplicates the natural landscape.

2.6 DRAINAGE

The goals of the drainage design standards for the MacDonald Highlands project are consistent with the overall desire to maintain the natural integrity of the hillside community. As the purpose of the grading design standards is to keep the hillsides in their natural condition as much as possible so to is the purpose of the drainage design standards. Grading and drainage play critical roles in appropriate hillside development, since the handling of these issues will directly impact both the physical and the visual impact that is created by the development. Care must be taken to respect and preserve the natural drainage patterns, at the same time protecting the proposed developments.

Every development project in the MacDonald Highlands community will be required to submit a detailed drainage plan prepared by a registered Nevada Civil Engineer to the Design Review Committee, as well as obtaining approvals from the governing entities at the City of Henderson. The overriding principle behind the drainage design standards for the MacDonald Highlands project is to utilize the natural existing drainage ways as much as possible. It will be the responsibility of every

developer/builder whether of a single custom home or of a larger parcel to maintain or reestablish the natural drainage patterns where those patterns are interrupted by his development project.

It is intended that storm flows will be conveyed to the major drainage ways by allowing local storm runoff to sheet flow as much as possible overland and across roads to natural drainage ways. Where necessary, roadside ditches and storm sewers may be used to collect runoff and direct it to the natural channels. Plans and designs for all drainage facilities and improvements must be approved by the City of Henderson Public Works Department.

Storm drainage channels will either be lined or unlined depending upon the flow velocities of the specific channel or channel sections. Lined channels or channel sections will be constructed mostly with native materials to look more natural and to conform to the natural channel slopes. Where concrete aprons are required to deal with low flow, nuisance water, or other situations, these aprons shall be designed and constructed in such a fashion so as to conform to the natural channel slopes and treated with Permeon. Unlined channels, once graded to the necessary elevations and widths, shall be finished in such a fashion so as to resemble the natural unlined channels in the MacDonald Highlands community and to blend with the surrounding area.

Where roadways cross major channels within the MacDonald Highlands project, culverts and energy dissipation structures may be necessary. Once the required structures have been built and the necessary channelization completed, the disturbed areas will be addressed with native materials and landscaping treatments to establish the natural desert appearance as it applies to washes and the surrounding area.

2.7 PARKING

Each Single Family Residence shall contain parking spaces within the Lot or Parcel for at least two automobiles in an enclosed garage either attached to or detached from the main structure of the Residence. Where the approved zoning represents a density equal to or less than RS-4, a minimum of three additional spaces for guest parking will be required on each lot. Two additional parking spaces for guest parking will be required on lots where the approved zoning represents a single family density greater than RS-4. No on-street parking will be permitted except on certain streets and only for special conditions as granted by the Association. In all situations, garage doors will not front the street unless approved by the Design Review Committee.

For cluster housing, condominium, clubdominium, or multi-family residential development, the Design Review Committee may approve alternative parking including (a) a carport enclosed on not less than three sides, either attached directly to the main structure of the Residence or connected by a roof or major fence or (b) exterior parking areas which must be screened from view using landscaping, garden walls, or combinations of both. The minimum number of parking spaces required for condominiums or multi-family residential development shall conform to City of Henderson standards for the same type of product.

For Non-Residential Developments, open parking and covered areas shall be clustered in parking courts along internal private drives to enhance security. Pedestrian and automobile circulation shall be clearly defined. Special paving at parking court entries and landscape nodes between parking stalls is encouraged to soften the streetscape.

No boats, trailers, or other recreational vehicles shall be stored on-site unless they are parked inside an enclosed area, which is permanently attached to a main residence, or unless alternate storage plans are approved by the Design Review Committee.

2.8 SETBACKS

All Developments within MacDonald Highlands shall maintain setbacks and easements consistent with the setback standards described in Section 3.0 of these Design Guidelines. Variation of setbacks will be encouraged in the residential areas of moderate density to distinguish individual identities and avoid formal redundancy.

Within the Non-Residential projects, no building or parking will be permitted closer than 15 feet to the right-of-way or as specified in the Henderson Development Code. This area shall be landscaped consistent with the design concepts set forth by these Guidelines.

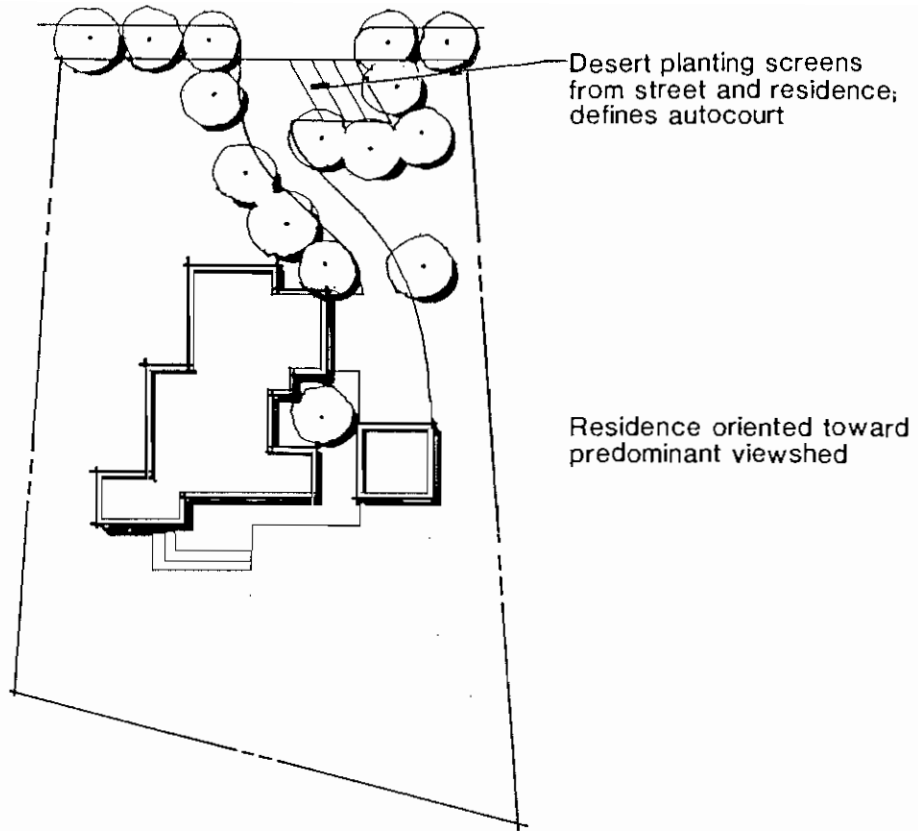

Residential Offstreet Parking One Residence

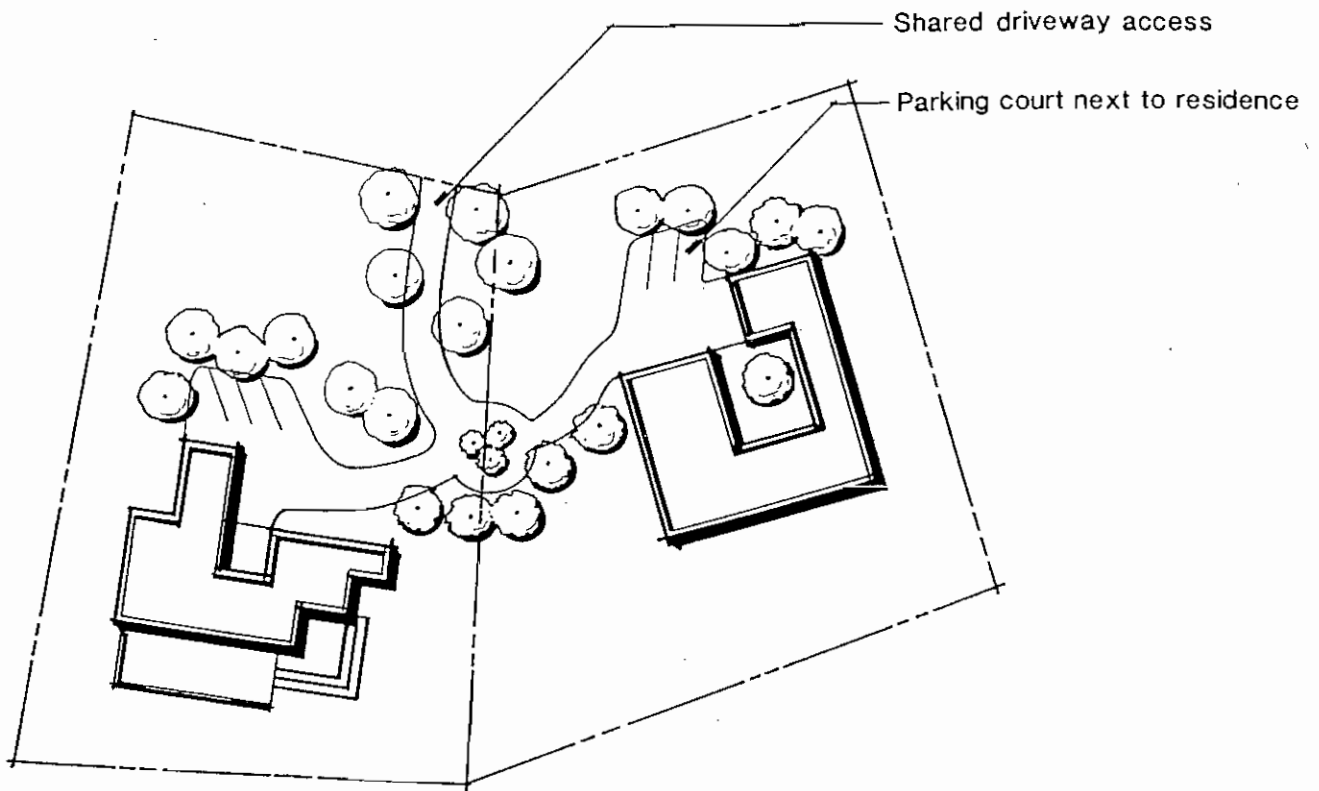

Residential Offstreet Parking Two Residences Non-Collector Streets Only

2.9 LIGHTING

The goal of an overall lighting plan for MacDonald Highlands is to provide a cohesive lighting theme throughout the entire site. The unified, natural effect desired will utilize up lighting of trees to enhance the beauty of the night at MacDonald Highlands. Lighting shall be utilized only as necessary to provide the functional requirements of safety, security, identification, and an aesthetically pleasing environment. Featured vistas and landmarks may be highlighted to provide dramatic accents. The design must balance the level of security with aesthetics without providing an over-lit or washed-out environment.

Vehicular and pedestrian movement within the project will be examined so that hazard points will be identified and properly illuminated.

We prefer to use the technique of minimal street lighting and maximum landscape lighting to enhance the aesthetic quality of the site. The lamp of choice, for the outer portion of the property, will be color-corrected High Pressure Sodium which will enhance the natural colors of the desert. In the more lush landscape areas, the lamps will be a warm color temperature (3000°K) Metal Halide and low wattage fluorescence for better color rendition. The overall feel should mimic the historical "gas light" quality with high color rendering properties. In all cases, the quality of the light shall be reviewed rather than just the quantity of light.

Where utilized within the community, light standards shall consist of a "bollard" type or other low profile design of masonry, concrete material, a fabricated metal, and ground cover such as

natural rock or pebble. The light source shall be shielded to reduce dispersal of ambient light in a skyward direction. The light shall be directed only down and onto the street in a limited radius. The standards shall be separated sufficiently to create isolated "pools of light" on the pavement, not a continuous, saturated condition. All light fixtures shall be shielded to prevent light trespass upon other properties. Pole fixtures for street, sports, and parking lots shall be of the cut-off variety, which will direct all light down on the horizontal surfaces. Horizontal distribution lights such as wall packs and floodlights are discouraged. If used, they must be shielded and baffled as not to be viewed from the edge of the property.

In keeping with this philosophy, the use of low-pressure sodium or incandescent fixtures is encouraged. Energy efficient low voltage lighting should be used in all landscaped areas. Other issues such as glare control and long-term maintenance will also be factored into the design process. Individual design cases shall be reviewed independently by the Design Review Committee.

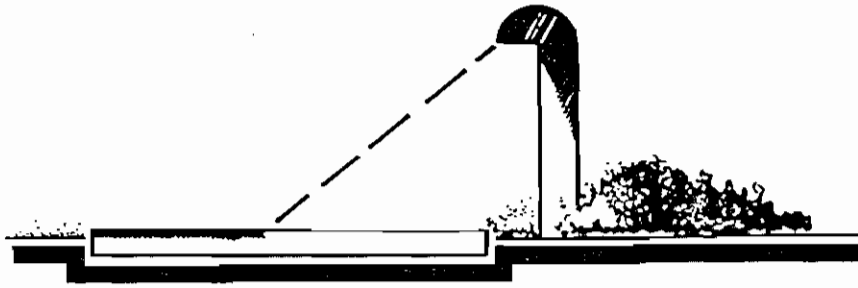

Bollard Lighting Along Fitness Paths & Bikeways

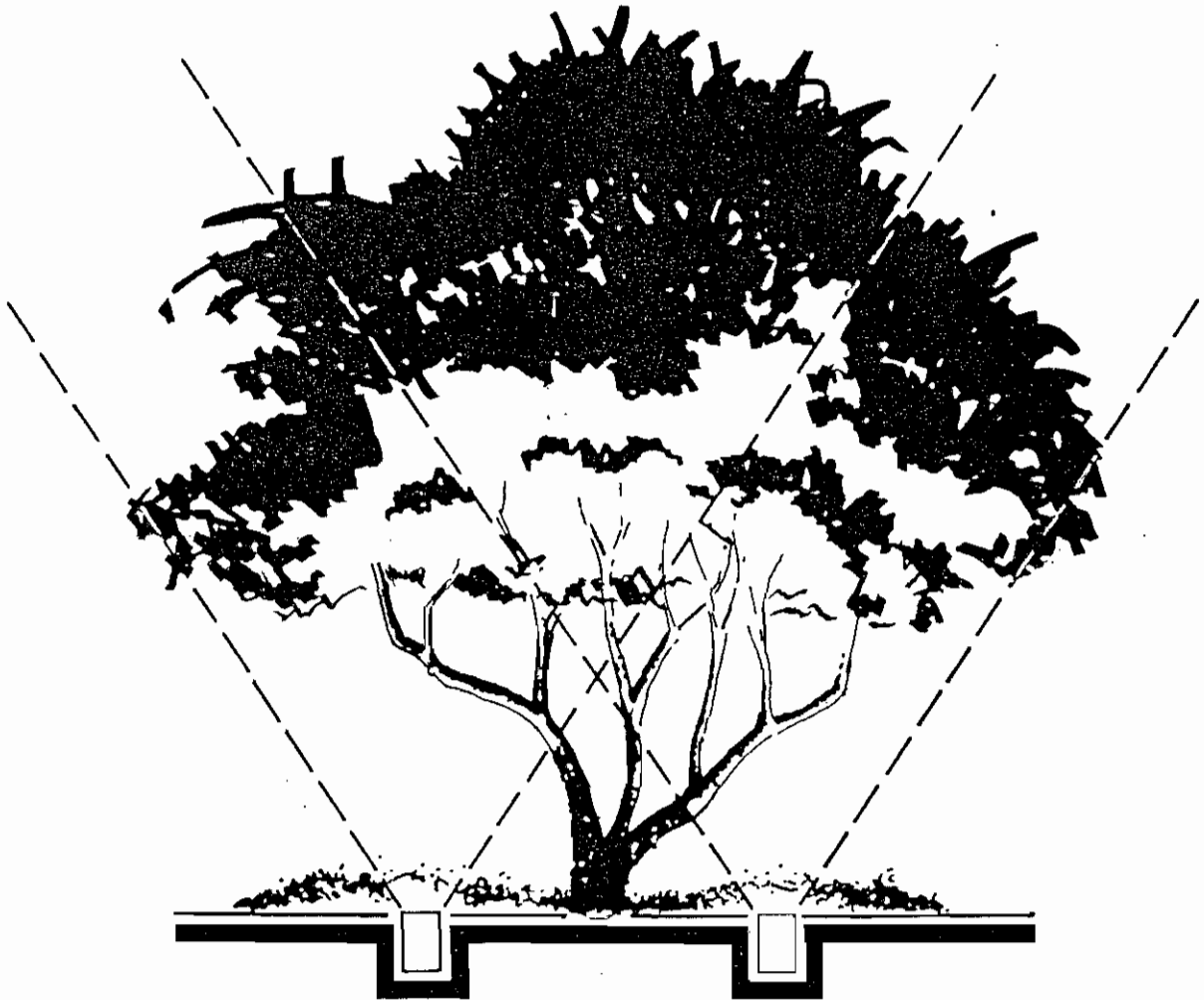

Landscape Uplighting of Trees From Ground

2.9.1 Architectural Lighting: Wherever monumental architectural elements occur within MacDonald Highlands, they will be enhanced with illumination. These would include entry gateways, gatehouses, and/or other architectural elements. The architecture of the buildings should suggest the type or style of lighting. All lights shall provide a soft-themed effect with a maximum foot-lambert of 5 foot-candles. Major identity elements will be illuminated to provide a site reference and project identity. Visible lamps are discouraged unless they are thematic and integrated with the design and are approved by the Design Review Committee. All visible lamps shall be steady-burning. The use of exposed neon is prohibited. Designs using integrated illuminated cavities with "glow from within" effect are encouraged. Sensitive lighting of the back-of-house areas shall be required to eliminate glare.

Highlighting the architectural icons is extremely important to the project. Care should be taken to minimize glare from visible lamps, but multiple techniques can be used to express these icons and further enhance the overall architectural continuity of the individual site. All architectural lighting (non-emergency and circulation) shall be on separate control circuits for maximum control. These lights throughout the entire complex shall be switched off at predetermined times.

Any back-of-house lighted areas shall be discreetly illuminated with non-visible light sources or glare-free optical units. Garage lighting equipment is to be shielded so as not to be viewed from the exterior of the garages. Poles

in parking lots also provide house-side shields to eliminate light from transmitting outside the parking lot boundaries. Any type of sport courts (basketball, tennis, volleyball, etc.) can be illuminated for nighttime use. However, cut-off fixtures must be used and the covers must only be illuminated to recreational lighting levels as established by the Illuminating Engineering Society of North America's Lighting Handbook. Light spillage onto adjacent property is strictly prohibited. All sports lights must be on a timer switch or occupancy sensor so they turn off when not in use. Additional safety and circulation lighting can remain on. Pole heights are limited to 20 feet. All fixtures shall also have house side glare shields. The reason for this stringent control is the uncontrollable spill light created by requirements of typical sports illumination.

2.9.2 Landscape Lighting: Landscape is of great importance to this project. Visual icons, views from interior spaces, and the overall site shall be coordinated to enhance views both during the day and evening. The use of appropriate light sources and concealed fixtures shall be required.

2.9.3 Graphics: The entry into MacDonald Highlands at Stephanie Street and MacDonald Ranch Drives will be illuminated with recessed Metal Halide ground-mounted wall wash up-lights. The light shall be placed and shielded in accordance with the Dark Sky standard. Signage brightness shall not exceed 20 foot-lamberts. Informational and directional signs need not be illuminated. Positive contrast between reflective letters or backgrounds is recommended for visibility with automobile headlights. When graphic illumination is

required, recessed floodlighting or cantilevered down-lights are recommended to provide even face illumination. Sign boxes and internally illuminated elements are discouraged.

2.9.4 Pedestrian Lighting: Whenever a pedestrian walkway intersects another path or a vehicular or service roadway, the intersection shall be illuminated. The use of cut-off fixtures or bollards and higher light levels shall be used to identify this area. In addition, a change in texture on the paving material is also recommended.

Low level path lighting is highly desired to support pedestrian activity along the landscaped areas of MacDonald Highlands. All major pedestrian paths shall be illuminated with cut-off optic poles, down-lights in trees, glare-free bollards, or low level landscape lighting. Areas of possible safety hazards including steps, grade changes, etc., shall be illuminated to a higher level of light through the use of bollards, poles, or recessed steplights. All fixtures shall be glare-free and direct the light down towards the ground.

2.9.5 Roadway Illumination: Major roads shall be illuminated with High Pressure Sodium cut-off fixtures. The recommended fixtures shall be either themed or shoe box fixtures mounted on poles. Pole height shall not exceed 20 feet. Foot-candle levels and uniformity levels as described by the IES will be met. Intersections and curbs shall be illuminated to a slightly higher level.

2.10 FENCES AND WALLS

Introduction & Philosophy: As a luxury, view-oriented community, MacDonald Highlands is designed to have a minimal amount of fences and walls. In order to preserve the spectacular scenery unique to MacDonald Highlands, the Design Review Committee reserves the right to approve the location, materials, color, columns, and design of all fences and walls.

MacDonald Highlands' development theme has been expressed as casual country estate and rural atmosphere. While there will be some parcels which will be developed in a more urbanized design pattern, the majority of the MacDonald Highlands project and especially the Hillside Estates areas will be developed with this rural country estate design theme. In order to establish and maintain this overall rural ambiance and to preserve the natural hillside terrain, the community will discourage and prevent the proliferation of walls.

In those areas identified as Hillside Estates, the construction of walls for the purpose of identifying property lines of an individual lot or for confining animals is prohibited. The construction of boundary walls and property line walls by the Master Developer of a parcel may be allowed upon review and approval of the design and purpose by the Design Review Committee. Types of walls used in the development of individual lots that will be considered for approval by the Design Review Committee in Hillside Estates areas are structural support walls, retaining walls, and security walls, which are designed and constructed as an integral part of the residential structure. Where security walls are necessary, they will be designed and constructed under the parameters for "view walls."

In those areas of the MacDonald Highlands community which are not identified as Hillside Estates areas, the use and construction of walls for the purpose of identifying individual lot property lines as well as security, screening, and retaining will be permitted as long as the design and construction is consistent with the standards established in these design guidelines and is approved by the Design Review Committee.

All walls within the MacDonald Highlands community shall be constructed of a solid masonry material except where the design standards call for metal components. Any walls that are not constructed entirely of native materials will, as a minimum, have exterior surfaces that are constructed of native materials, which complement the natural desert environment, colors, and materials.

All fences and walls desired on a shared property line will be per community-design standards and coordinated between the property Owners. For the portions of the wall that are exposed, double split-face block is required and the cost of the construction of said exposed wall ***will be shared*** by both adjacent Owners. For those walls or portions of walls that are needed or create a retaining situation, the cost of construction will be the sole responsibility of the Owner creating the retaining situation(s). Only one wall will be permitted on any property line.

All fences and walls along a roadway or common open space, where approved by the DRC, will be constructed per community-design standards.

The design and construction of all walls in the MacDonald Highlands community must be approved by the Design Review Committee. The following types of walls and their associated design criteria are further described in this section and in the appropriate Architectural Guidelines sections.

Chain link and/or perimeter fencing is not permitted, except during construction. Furthermore, exposed wall-top security devices such as concertina wire is prohibited. Because the site affords such dramatic view potential, it is strongly encouraged that open fencing be used predominantly within MacDonald Highlands.

Pool fencing should follow the same standards for openness, visibility and design, but compliance with City, County, and State Ordinances is essential.

Special attention to waterproofing and location of irrigation spray heads will be necessary in order to eliminate leaking, staining, aesthetic, or structural problems.

2.10.1 Perimeter or Boundary Walls

Within the MacDonald Highlands community, the term Perimeter Wall will be used to identify those walls used around the exterior perimeter of the MacDonald Highlands community. Typically, such perimeter walls will be 5 to 6 feet with the standard height being 6 feet, except for short sections where the wall steps up or down to transition a change in elevation.

Certain situations may arise that necessitates the construction of a boundary wall between two parcels. Where this necessity has been reviewed, acknowledged, and approved by the Design Review Committee, the developer may construct such a wall. The design of such boundary walls is subject to the review and approval of the Design Review Committee. The use of open type view walls for these situations is encouraged. The Design Review Committee discourages the use of solid masonry walls that will block views.

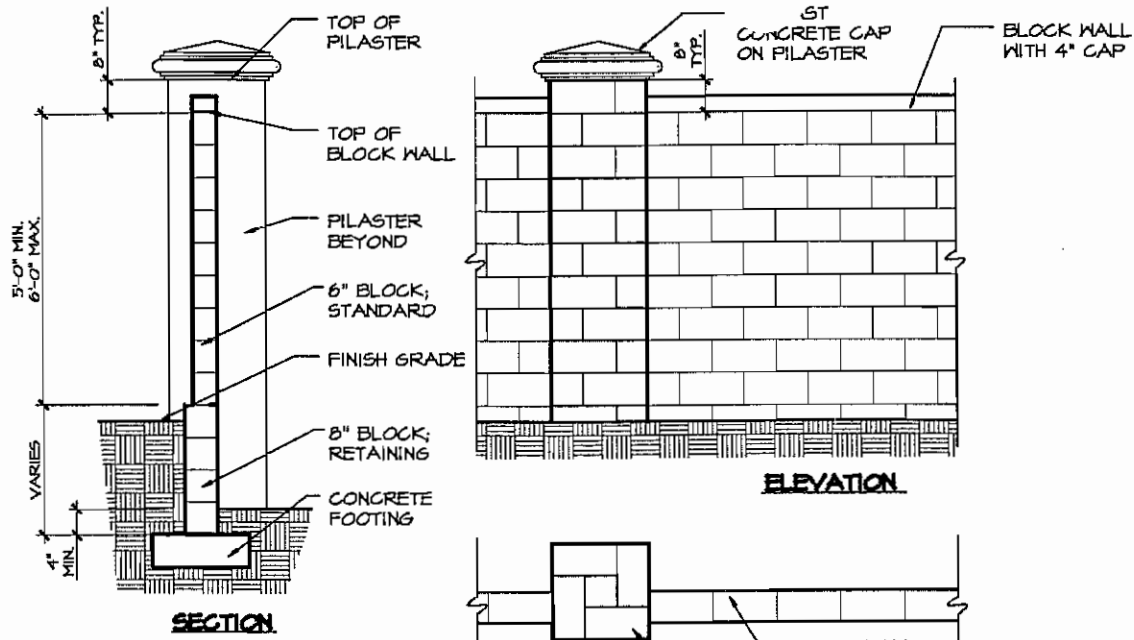

ELEVATION

SECTION

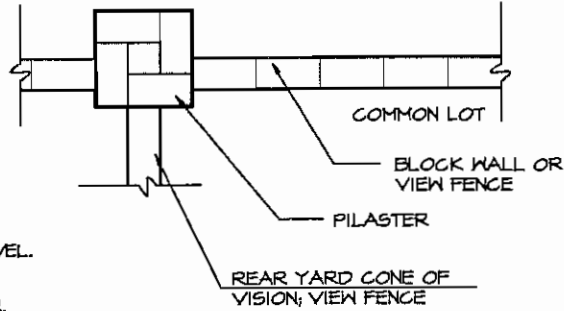

PLAN VIEW

GENERAL WALL NOTES:

1. FOOTINGS SHALL BEAR ON COMPETANT UNDISTURBED NATURAL SOIL OR COMPACTED FILL. REMOVE ALL LOOSE MATERIAL BEFORE CONCRETE PLACEMENT. GRADE CHANGES SHALL BE MADE USING STEP FOOTING DETAIL. OTHERWISE TOP OF FOOTING SHALL BE APPROXIMATELY LEVEL. DO NOT CONSTRUCT WALL OVER HIGHLY EXPANSIVE OR COLLAPSABLE SOIL OR OVER SOIL FISSURES WITHOUT SOIL STABILIZATION AS DIRECTED BY A GEOTECHNICAL ENGINEER.
2. HOLLOW LIGHTWEIGHT CONCRETE MASONRY UNITS SHALL CONFORM TO ASTM C90, GRADE N, TYPE I WITH 1900 PSI MIN. COMPRESSIVE STRENGTH.
3. STEEL REINFORCING BARS SHALL BE ASTM A615, GRADE 40 FOR #4, GRADE 60 FOR #5 AND LARGER.
4. DO NOT SLOPE RETAINED SOIL TOWARD WALL. PROVIDE POSITIVE DRAINAGE AWAY FROM WALL ON BOTH SIDES.
5. VERTICAL EXPANSION OR CONTROL JOINTS SHALL BE MADE ON FENCE WALLS AT INTERVALS NOT TO EXCEED 25' O.C.. HORIZONTAL REINFORCING NEED NOT BE CONTINUOUS THRU JOINT WHERE PLASTER BLOCK IS USED.
6. VERTICAL EXPANSION OR CONTROL JOINTS ON RETAINING WALL ARE OPTIONAL. FOR BEST RESULTS, JOINTS ARE RECOMMENDED AT INTERVALS NOT EXCEEDING 25' O.C..
7. DO NOT LOCATE WITHIN DISTANCE "A, B, C, OR D" (WHICHEVER IS APPLICABLE) OF UPPER SIDE OF WALL, ANY BUILDING FOUNDATION, PARKING, ROADWAYS, LARGE TREES OR ADDITIONAL RETAINING WALLS.
8. INSPECTION OF CONSTRUCTION SHALL BE ACCOMPLISHED ACCORDING TO ALL DIRECTIVES GIVEN BY BUILDING DEPARTMENT OFFICIALS.

CONCRETE:
CONCRETE SHALL BE 5 SACK MINIMUM, TYPE V CEMENT WITH A 6" MAX. SLUMP. 28 DAY STRENGTH SHALL EXCEED 2500 PSI. PLACE CONCRETE TO MINIMUM DIMENSIONS SHOWN WITH 3 INCHES COVER TO ALL REINFORCING STEEL.
A GOOD CONCRETE MIXTURE FOR FOOTING IS BY VOLUME, 1 PART PORTLAND CEMENT, 2.75 PARTS SAND, 4 PARTS GRAVEL NOT LARGER THAN 1.5 INCHES, AND JUST ENOUGH WATER TO MAKE THE MIXTURE "MUSHY" AND WORKABLE, BUT NOT "SOUPY". THE WATER CONTENT SHOULD NOT BE MORE THAN 7.5 GALLONS PER SACK OF CEMENT FOR THE ABOVE MIX.

MORTAR:
MORTAR SHALL BE 2000 PSI TYPE S. A GOOD MORTAR MIXTURE SHOULD BE IN PROPORTIONS OF 1 PART PORTLAND CEMENT, 1/3 PART LIME (HYDRATE), AND 3 PARTS SAND. THE WATER CONTENT SHOULD BE ACCORDING TO ABSORPTION AND SUCTION ABILITY TO ASSURE NORMAL FLOW AND SPREADING WITH A TROWEL.

GROUT:
GROUT SHALL BE 2000 PSI. A GOOD GROUT MIXTURE SHOULD BE COMPOSED OF VOLUME OF 1 PART PORTLAND CEMENT, 2 PARTS SAND, AND 1 PART PEA GRAVEL. SUFFICIENT WATER SHALL BE ADDED TO PRODUCE CONSISTENCY FOR POURING WITHOUT SEGREGATION.

BLOCK:
CONCRETE BLOCK IS CSR BROWN #2 DOUBLE SPLITS. STANDARD WALL BLOCK IS 6" x 8" x 16". IF RETAINING OVER 24" BLOCK IS 8" x 8" x 16". SOLID SMOOTH CAP IS 4" x 6" (or 8") x 16" FLUSH WITH BLOCK WALL, COLOR TO MATCH BLOCK.

PILASTER CAP:
PRECAST CAP AVAILABLE AT 'ARCHITECTURAL PRECAST, INC.' 702.643.7000, CONTACT IS KIRK. DIMENSIONS AS SHOWN. COLOR TO BE STANDARD MRCC PRECAST CAP COLOR.

NOTE: EACH OCCURRENCE THAT EXCEEDS THE STANDARD WALL HEIGHT FOR THE CITY OF HENDERSON IN ORDER TO MEET POOL SAFETY REQUIREMENTS WILL HAVE TO GO TO THE CITY FOR APPROVAL OF A VARIANCE.

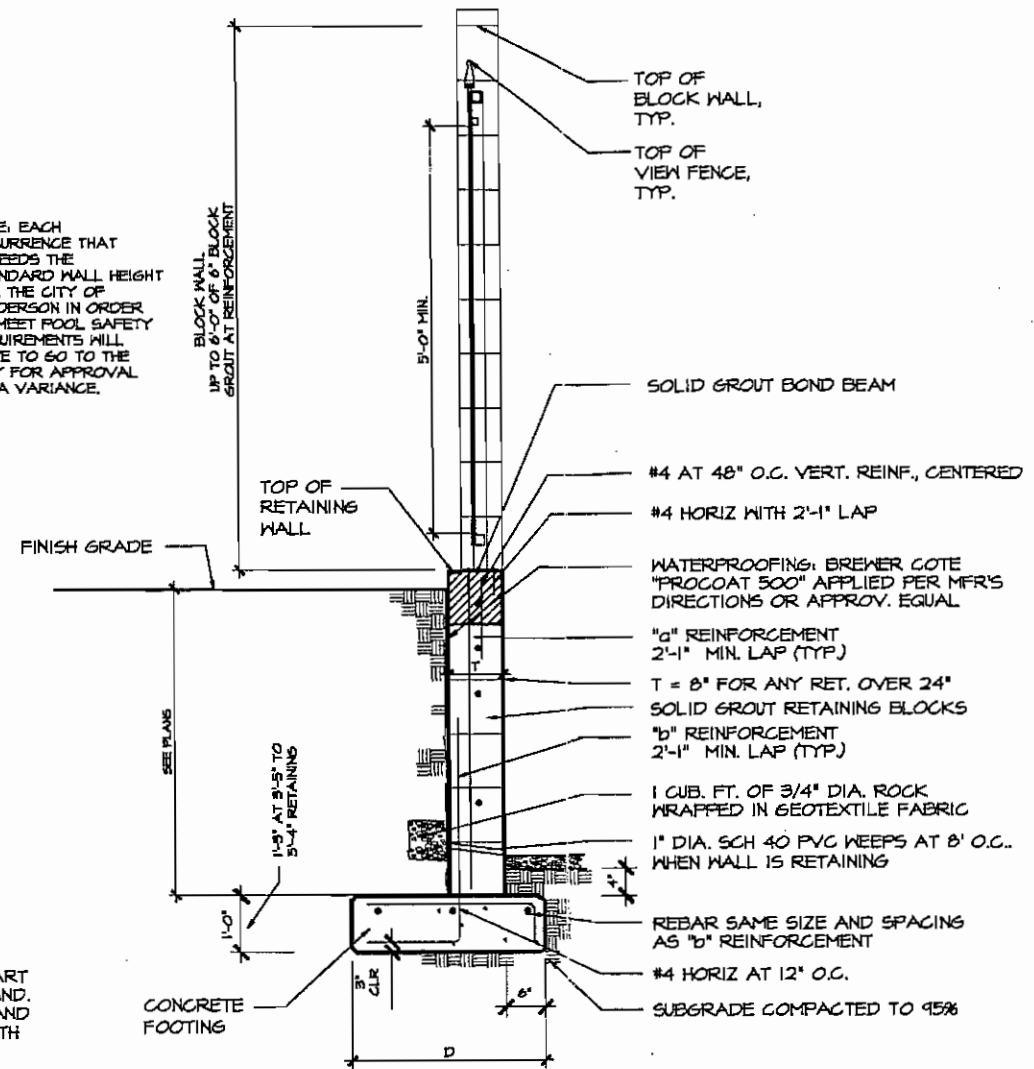

6" TO 5'-4" RETAINING WALL WITH 6" SCREEN WALL

REINFORCING SCHEDULE

BLOCK THICKNESS	RETAINED HEIGHT	FOOTING DEPTH	REINFORCEMENT	
			VERTICAL	HORIZONTAL
0" to 8"	RETAINING	2'-0"	#4 @ 48" O.C. VERT.	NA
6"	9" to 24" RETAINING	2'-0"	#4 @ 16" O.C. VERT.	NA
8"	2'-1" to 3'-4" RETAINING	2'-6"	NA	#4 @ 24" O.C. VERT. #4 @ 24" O.C. HOR.
8"	3'-5" to 5'-4" RETAINING	4'-0"	NA	#5 @ 8" O.C. VERT. #4 @ 24" O.C. HOR.



2.10.2 View Walls

The use of "view walls" for purposes other than to provide retaining or structural support is encouraged within the MacDonald Highlands community. Lots along the golf course, open space or possess strong view orientations may install a community-designed view wall on the rear property line. Where permitted, view walls will be used to delineate property lines, to provide security fencing, to enclose properties, etc. All architectural designs and colors are subject to compliance with the appropriate sections of these design guidelines and approval by the Design Review Committee.

The design of View Walls should promote the open view oriented characteristics of the MacDonald Highlands community. View walls shall be designed to minimize massing impacts on the community and to minimize any visible barriers to views that would result from the construction of such walls. The use of open distinctive ornamental metal materials for such walls is encouraged. A solid masonry base no higher than 18" may be approved by the Design Review Committee depending upon the architectural design and materials. Masonry pillars to support the metal sections may be approved by the Design Review Committee depending upon the architectural design and materials. All masonry components of view walls will have exterior surfaces that are constructed of native materials, which complement the natural desert environment and colors.

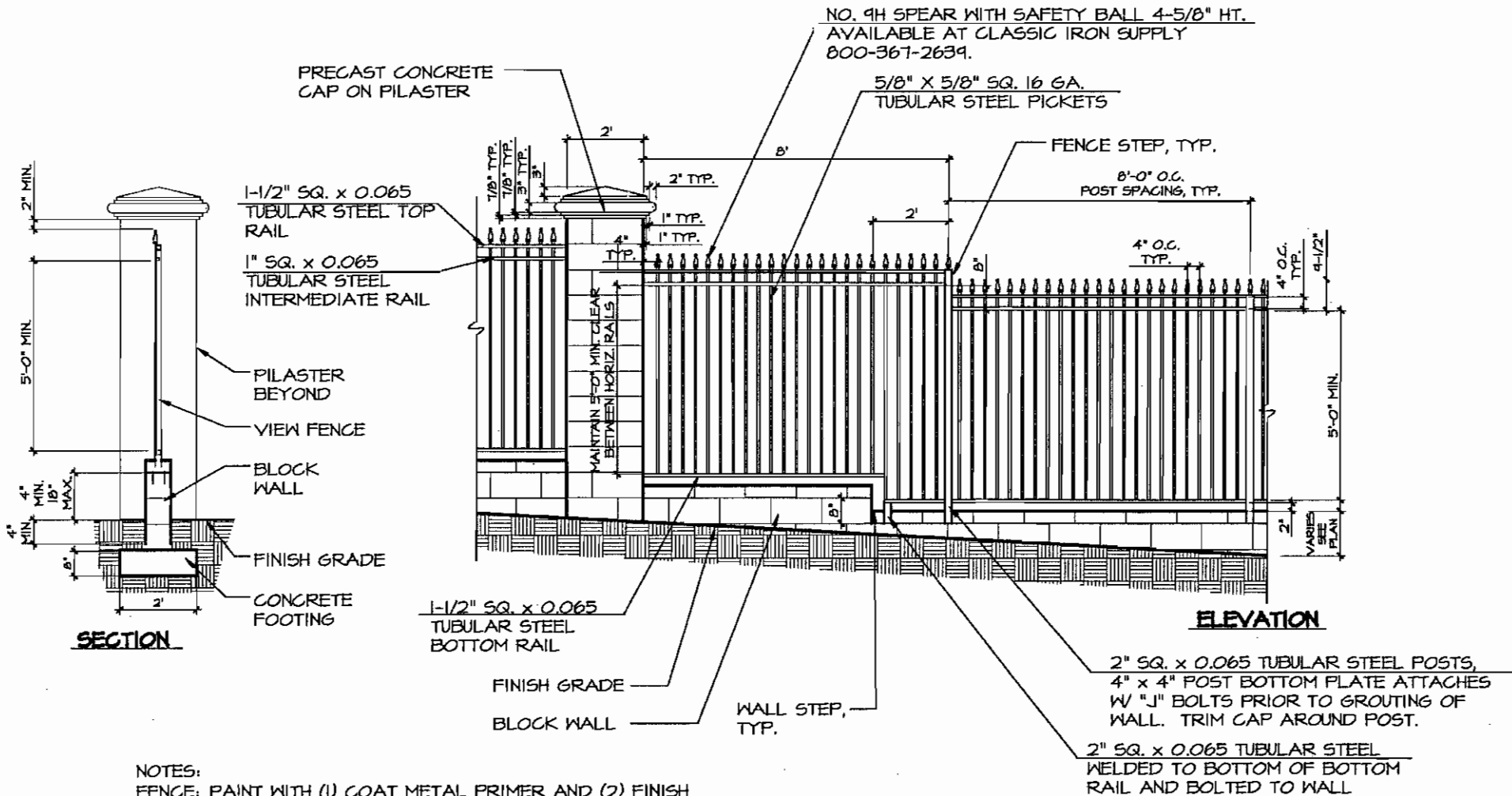

NOTES:

FENCE: PAINT WITH (1) COAT METAL PRIMER AND (2) FINISH COATS. PAINT COLOR TO BE AMERON 450HS "FOOTHILLS MAHOGANY".

BLOCK: CONCRETE BLOCK IS CSR BROWN #2 DOUBLE SPLITS. STANDARD WALL BLOCK IS 6" x 8" x 16". IF RETAINING OVER 24" BLOCK IS 8" x 8" x 16". SOLID SMOOTH CAP IS 4" x 6" (or 8") x 16" FLUSH WITH BLOCK WALL, COLOR TO MATCH BLOCK.

CONNECTIONS: HORIZONTAL RAILS ARE TO BE WELDED TO POSTS. WELDS SHALL BE CONTINUOUS AROUND RAILS AND GROUND SMOOTH PRIOR TO PAINTING.

PILASTER CAP:

PRECAST CAP AVAILABLE AT 'ARCHITECTURAL PRECAST, INC.' 702.643.7000, CONTACT IS KIRK. DIMENSIONS AS SHOWN. COLOR TO BE STANDARD MRCC PRECAST COLOR.

2" SQ. x 0.065 TUBULAR STEEL POSTS, 4" x 4" POST BOTTOM PLATE ATTACHES W/ "J" BOLTS PRIOR TO GROUTING OF WALL. TRIM CAP AROUND POST.

2" SQ. x 0.065 TUBULAR STEEL WELDED TO BOTTOM OF BOTTOM RAIL AND BOLTED TO WALL

EACH OCCURRENCE THAT EXCEEDS THE STANDARD WALL HEIGHT FOR THE CITY OF HENDERSON IN ORDER TO MEET POOL SAFETY REQUIREMENTS WILL HAVE TO GO TO THE CITY FOR APPROVAL OF A VARIANCE.

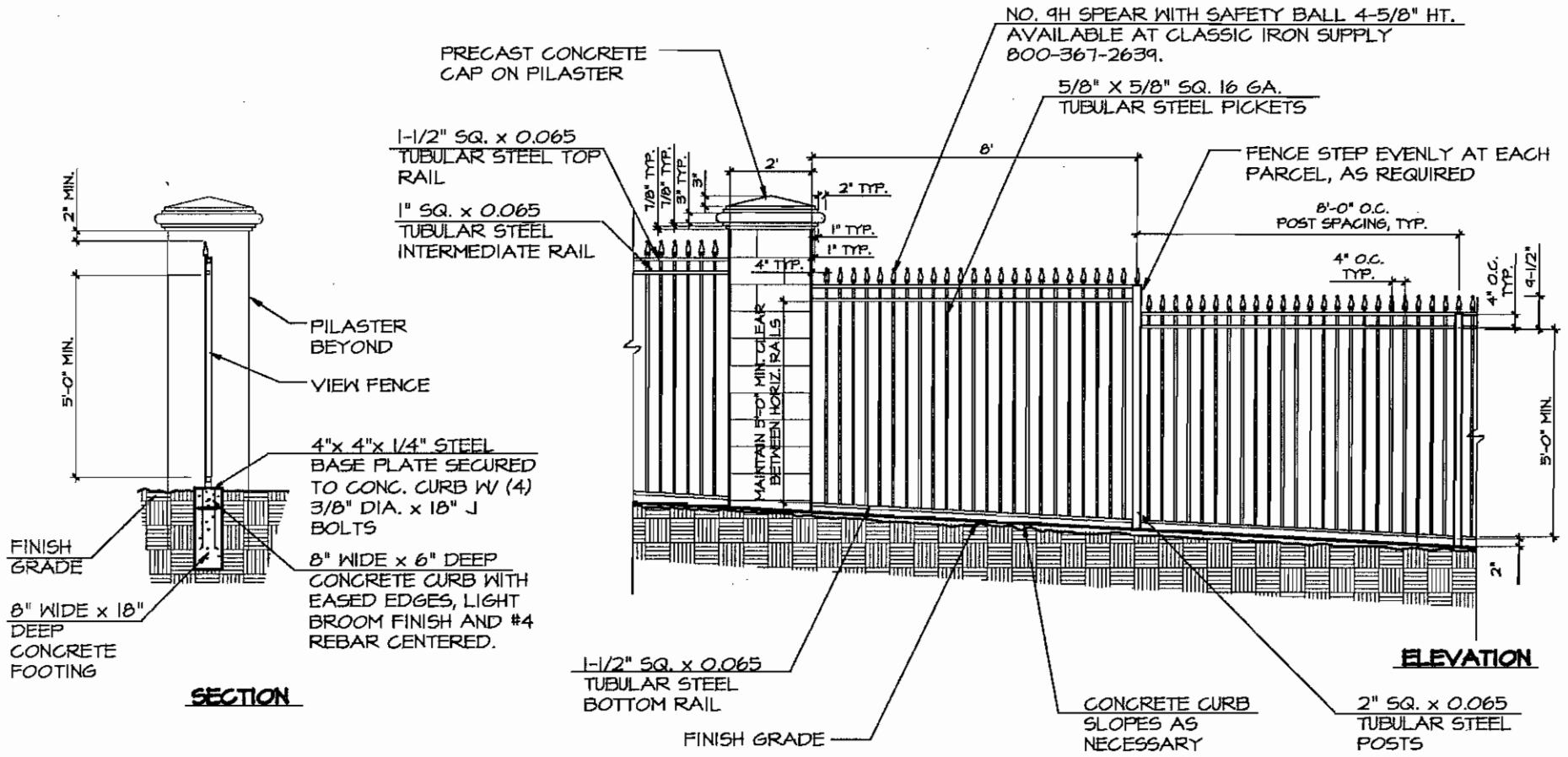

NOTES:
 FENCE: PAINT WITH (1) COAT METAL PRIMER AND (2) FINISH COATS. PAINT COLOR TO BE AMERON 450HS "FOOTHILLS MAHOGANY".

CONNECTIONS: HORIZONTAL RAILS ARE TO BE WELDED TO POSTS. WELDS SHALL BE CONTINUOUS AROUND RAILS AND GROUND SMOOTH PRIOR TO PAINTING.

PILASTER: CONCRETE BLOCK IS CSR BROWN #2 DOUBLE SPLITS.

PILASTER CAP:
 PRECAST CAP AVAILABLE AT 'ARCHITECTURAL PRECAST, INC.' 702.643.7000, CONTACT IS KIRK. DIMENSIONS AS SHOWN. COLOR TO BE STANDARD MRCC PRECAST COLOR.

Exhibit "J"
Page 2.30

VIEW FENCE EXHIBIT



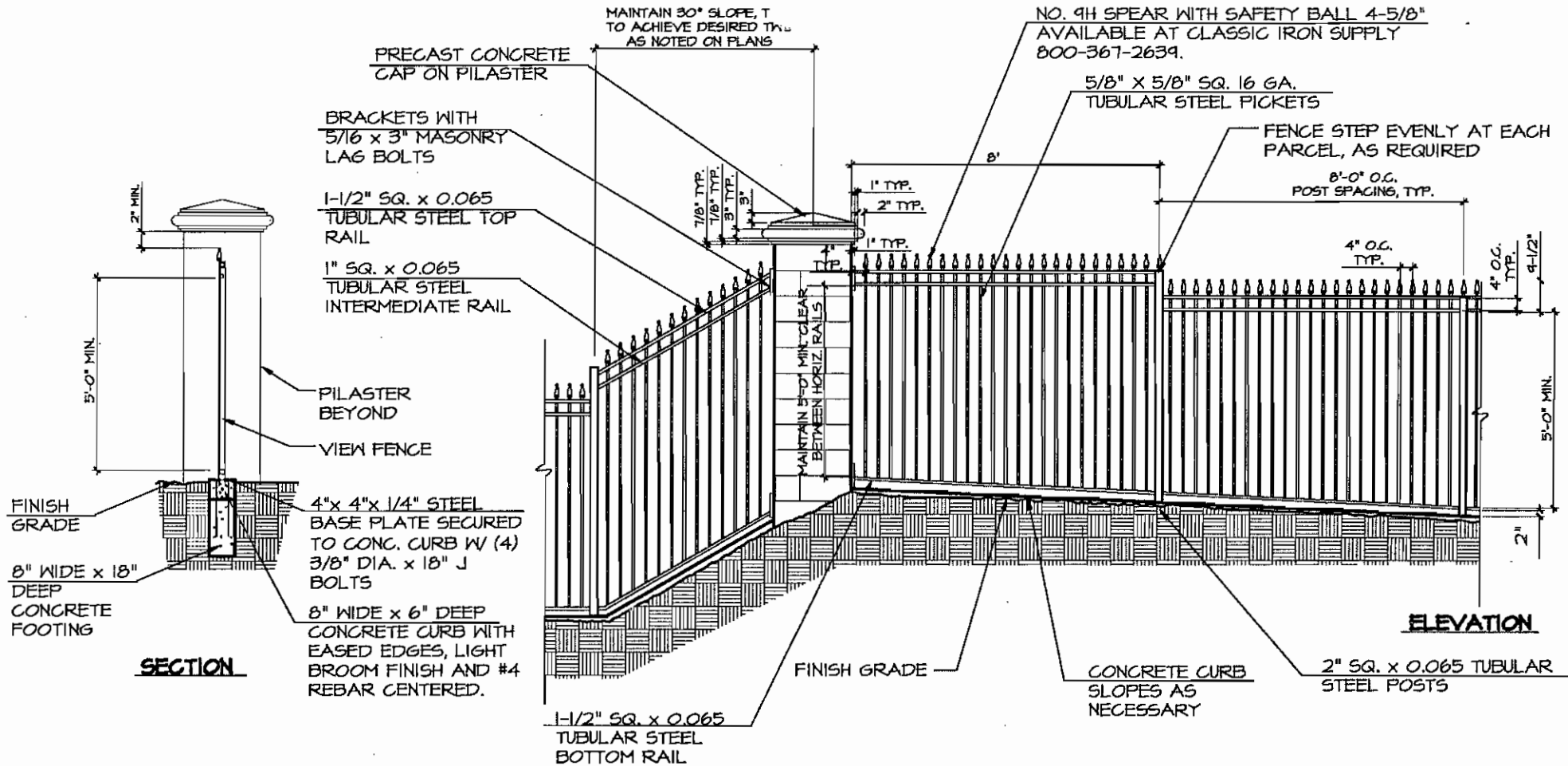

NOTES:

FENCE: PAINT WITH (1) COAT METAL PRIMER AND (2) FINISH COATS. PAINT COLOR TO BE AMERON 450HS "FOOTHILLS MAHOGANY".

CONNECTIONS: HORIZONTAL RAILS ARE TO BE WELDED TO POSTS. WELDS SHALL BE CONTINUOUS AROUND RAILS AND GROUND SMOOTH PRIOR TO PAINTING.

PILASTER: CONCRETE BLOCK IS CSR BROWN #2 DOUBLE SPLITS.

PILASTER CAP:

PRECAST CAP AVAILABLE AT 'ARCHITECTURAL PRECAST, INC.' 702.643.1000, CONTACT IS KIRK. DIMENSIONS AS SHOWN. COLOR TO BE STANDARD MRCC PRECAST CAP COLOR.



Netting, screens and excessive landscaping will not be permitted against view walls. However, in areas requiring pet containment, non-reflexive glass, wire mesh, expanded steel, tempered glass or invisible fencing may be allowed and will be reviewed and approved on a case-by-case basis by the Design Review Committee. Permitted material as specified above may not exceed a height greater than 24-inches as measured from the bottom rail of the view fence.

ALL view wall fencing shall consist of 2" posts, 1.5" top and bottom rail, 1" middle rail, 5/8" pickets and 217 WB arrowheads, which are to be fixed atop all posts and pickets. All view wall fence shall be fabricated in the 'inlay style' and be powder coated to match custom Frazee Paint Color # 11028CCL (450HS Foothills Mahogany) [Exhibit "L"]. All contracts and pricing agreements shall strictly be between the specific Lot Owner, Developer and/or Builder and his/her chosen contractor.



Stephen Poole
 New Home Construction - Industrial
 Nevada Area Manager

FRAZEE PAINT & WALLCOVERING

Cell 702.604-3040
 e-mail: spoole@frazee.com

5280 S. Valley View
 Las Vegas, NV 89118
 702.895-9800
 Fax 702.597-5200

Custom Color # : 11028CCL
 Description : 450HS Foothills Mahogany
 Formulated By :

Version : 000
 Series : 450HS
 TintType: U
 Instr :
 Code :

Tint Base 450HSB00003 AMERCOAT 450HS NEUTRAL TINT

Ingredient	BL	TINT - LAMPBLACK UCD1625V	5	$\frac{16.0}{64}$	OZ.
Ingredient	RO	TINT - RED OXIDE UCD 6080V	1	$\frac{16.0}{64}$	OZ.
Ingredient	WT	TINT - TIO2 WHITE UCD-1106V	5	$\frac{24.0}{64}$	OZ.
Ingredient	YO	TINT - YELLOW OXIDE UCD5750V	3		OZ.

FRAZEE INDUSTRIES, INCORPORATED

6625 Miramar Road, San Diego, California 92121 • 858.626.3600 • FAX 858.452.3568

2.10.3 Retaining Walls

It is expected that there will be a significant need for retaining walls throughout the steeper sections of the MacDonald Highlands project. The use of retaining walls for the purpose of protecting and preventing unnecessary disturbance of the native desert environment is encouraged throughout the MacDonald Highlands community. Retaining walls may need to be stepped or terraced in some situations in order to prevent excessive concentrations of wall massing. Wall heights in excess of 8 vertical feet (measured from top of footing to top of wall) are discouraged. Where the topographic conditions necessitate retaining in excess of 8 vertical feet, the wall should be stepped or terraced so that no individual section has a height greater than 8 feet. The design and construction of all retaining walls must be submitted to the Design Review Committee for review and approval.

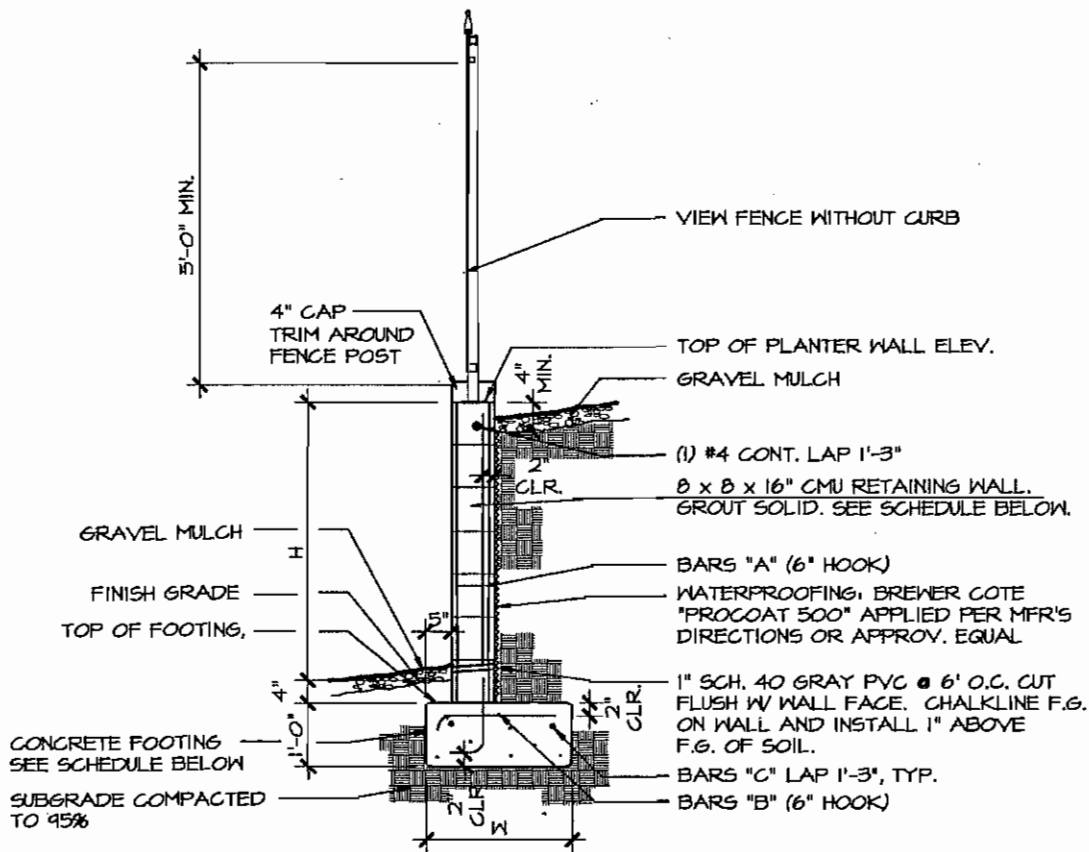

PLANTER WALL SCHEDULE

WALL	H	W	BARs "A"	BARs "B"	BARs "C"
W1	3'-4"	2'-6"	#4 @ 48"	#4 @ 48"	(2) - #4 CONT.
W2	4'-8"	3'-4"	#4 @ 24"	#4 @ 24"	(2) - #4 CONT.
W3	6'-0"	5'-0"	#5 @ 16"	#4 @ 16"	(3) - #4 CONT.

NOTES:

1. TOP OF WALL TO BE HELD LEVEL.
2. GROUT ALL OPEN JOINTS CREATED BY ANGLED WALLS TO A SMOOTH, EVEN FINISH. REPAIR CRACKS.
3. BLOCK: CONCRETE BLOCK IS CSR BROWN #2 SINGLE SPLIT ON PARK SIDE. SOLID SMOOTH CAP IS 4" X 8" X 16" FLUSH WITH BLOCK WALL, COLOR TO MATCH WALL.
4. EACH OCCURRENCE THAT EXCEEDS THE STANDARD WALL HEIGHT FOR THE CITY OF HENDERSON IN ORDER TO MEET POOL SAFETY REQUIREMENTS WILL HAVE TO GO TO THE CITY FOR APPROVAL OF A VARIANCE.



2.10.4 Rear Yard Cone of Vision

In all site design and layout, careful attention to open space is important. Those lots that front on the golf course, open space or possess strong view orientations may install a community-designed view wall on the rear property line. If a solid wall is desired along the side property line(s), the solid side yard wall must end at a distance of 15 feet from the property corner. A single pilaster is required at each property line corner on both sides in the rear. In addition, those lots that require preservation of view corridors will not be permitted to install improvements, plant trees or other plant material that are taller than 4 feet within a distance of 15 feet from the rear yard property corner.

2.10.5 Security Walls

All security walls within the MacDonald Highlands project must be designed and constructed using the design criteria established for View Walls and incorporating those specific code requirements for providing the required protection (such as for swimming pools). The design and construction of all security walls must be submitted to the Design Review Committee for review and approval.

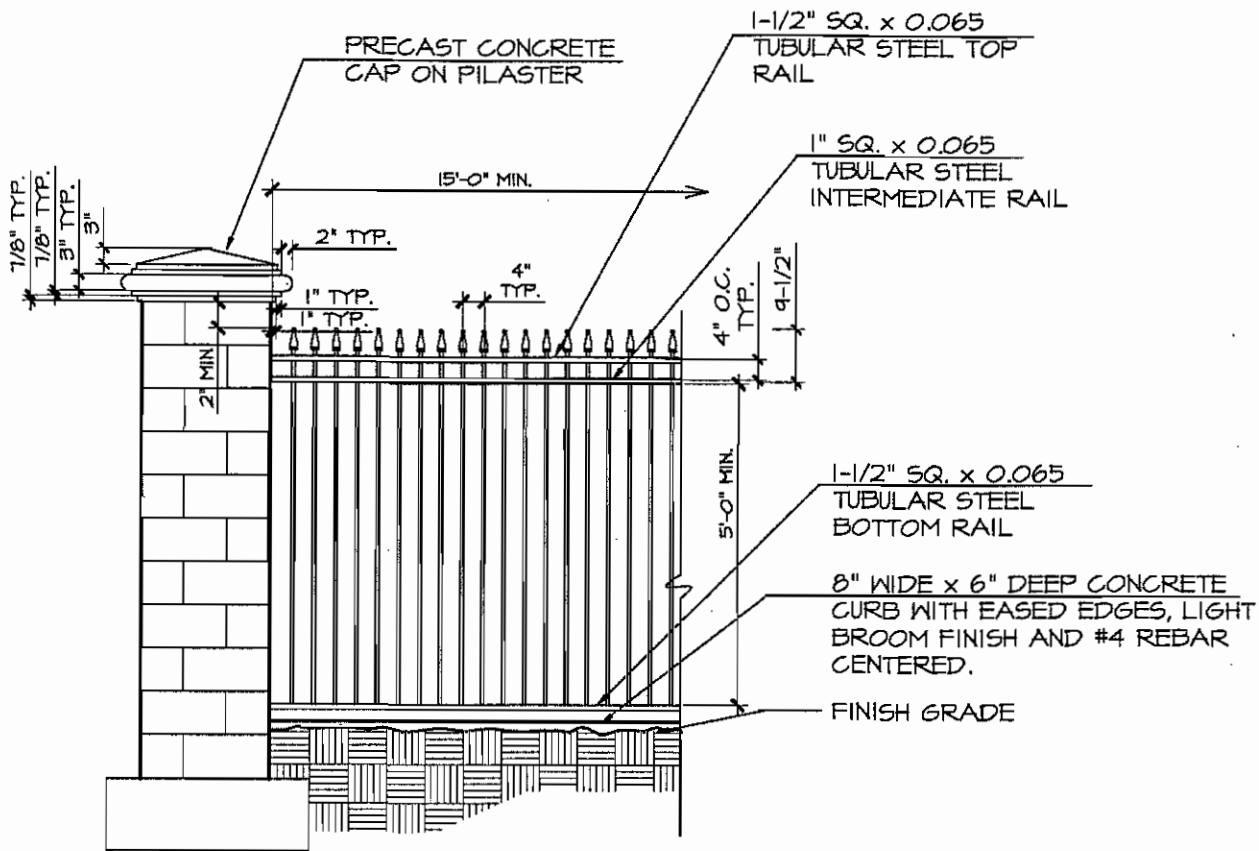

SIDE ELEVATION

NOTES:
 FENCE: PAINT WITH (1) COAT METAL PRIMER AND (2) FINISH COATS. PAINT COLOR TO BE AMERON 450HS "FOOTHILLS MAHOGANY".

CONNECTIONS: HORIZONTAL RAILS ARE TO BE WELDED TO POSTS. WELDS SHALL BE CONTINUOUS AROUND RAILS AND GROUND SMOOTH PRIOR TO PAINTING.

PILASTER: CONCRETE BLOCK IS CSR BROWN #2 DOUBLE SPLITS.

PILASTER CAP:
 PRECAST CAP AVAILABLE AT 'ARCHITECTURAL PRECAST, INC.' 702.643.7000, CONTACT IS KIRK. DIMENSIONS AS SHOWN. COLOR TO BE STANDARD MRCC PRECAST CAP COLOR.

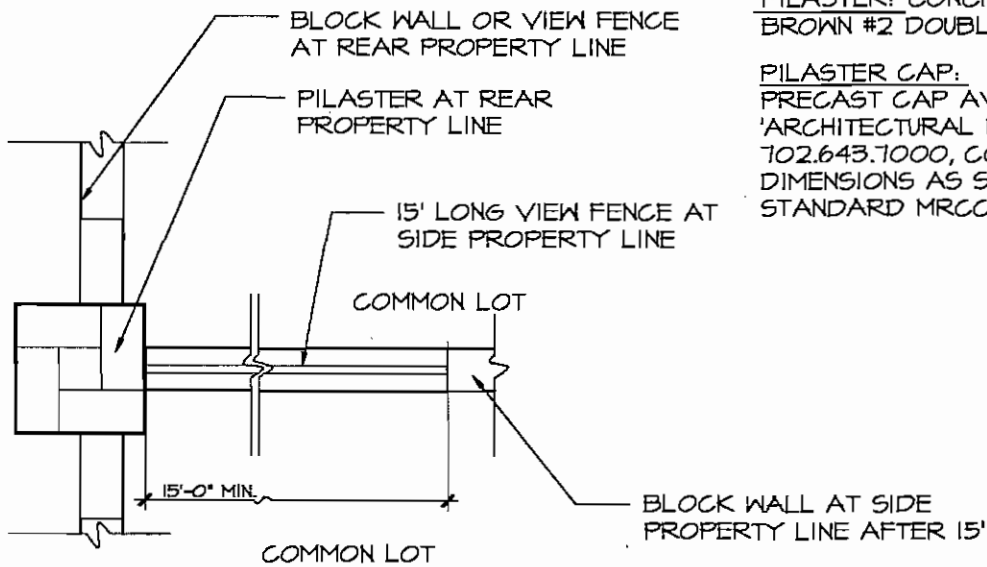

PLAN VIEW



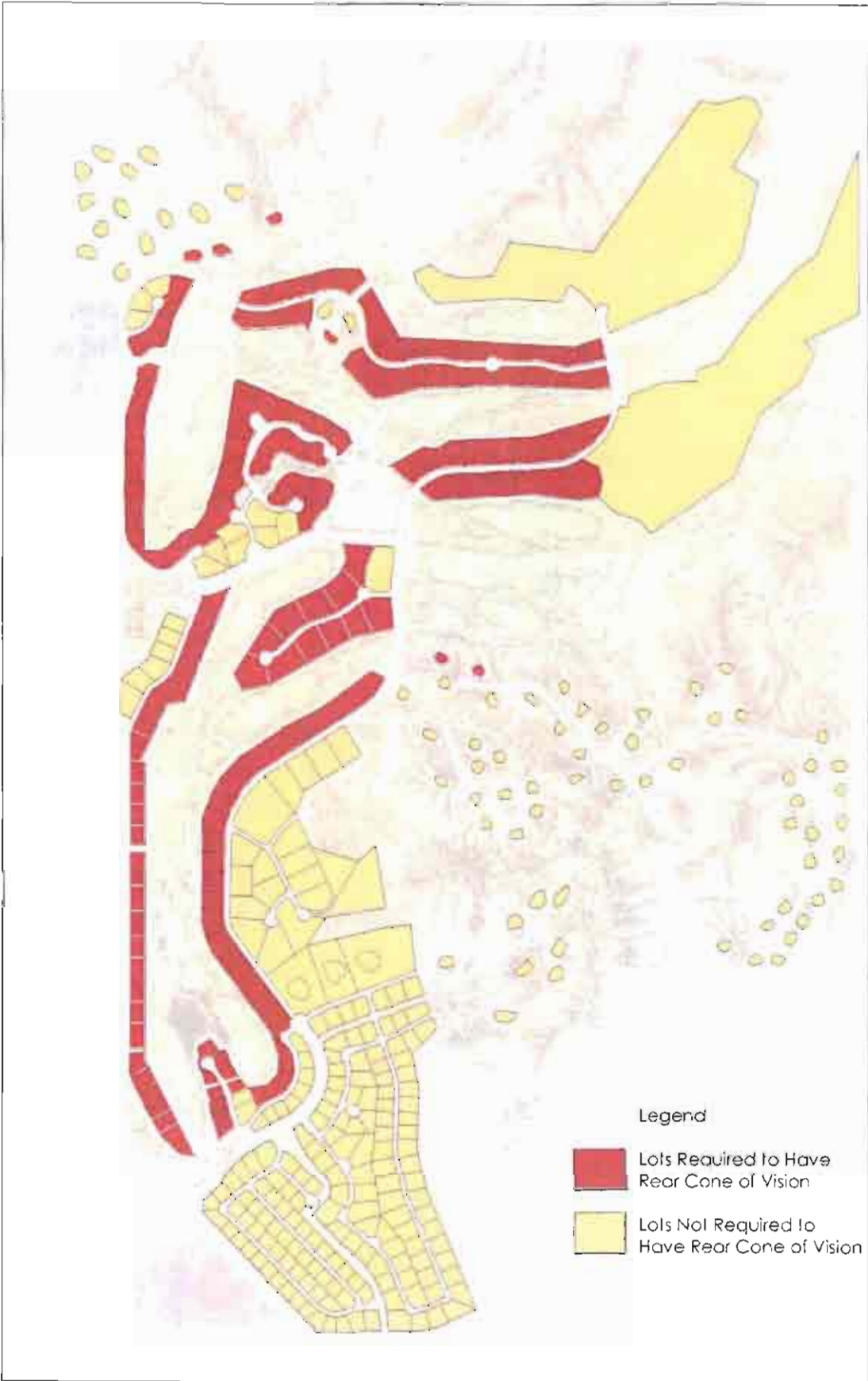

Rear Yard Cone of Vision Master Plan

2.10.6 Screening Walls

Where walls are necessary to provide screening for such things as parking courts, storage areas, etc. such walls shall be designed so as to minimize the impact on views of and from the community. Designing such walls in conjunction with the use of berming and other methods of landscape screening is encouraged. Designing such walls to simply be a solid vertical visual barrier is discouraged and it will be difficult to get approval of such from the Design Review Committee. The design and construction of all screening walls must be submitted to the Design Review Committee for review and approval.

2.10.7 Landscape Walls

The use of walls for the purpose of supporting native and imported landscape materials to reestablish, revegetate, and preserve the hillside areas is encouraged. Such walls may not be needed to provide retaining, screening, or other functions other than to support a particular landscape design. The construction of such walls entirely from native and on-site materials is also encouraged.

2.10.8 Windbreak Walls

In areas requiring wind protection, a glass or Plexiglass fence atop a low wall can help provide a windbreak while still preserving the drama of the hillside views.

2.10.9 Interior Wall Conditions

Alternate wall and fence designs *may be considered* for interior wall conditions (i.e., walls that are not located on a property line) subject to DRC review and approval. Please be advised standard gray CMU block is not permitted within the community. As a minimum, interior walls may be stuccoed and painted to match the residence, although the community-preferred CSR Brown #2 splits is favored.

2.11 FOUNDATIONS

All exterior wall materials must be continued down to finish grade thereby eliminating unfinished foundation walls. On hillside Lots or Parcels, open areas created by cantilevers or decks, shall be fully enclosed.

2.12 UTILITIES

All utility services shall be installed underground. Locate exterior transformers, utility pads, cable TV and telephone boxes out of view, or screen with architecturally integrated walls, fences, or vegetation. Electrical service shall also be located underground. All utility locations are to be closely coordinated with Declarant and must conform to the appropriate local authorities.

2.13 SERVICE AREAS

All above-ground garbage and trash containers, clotheslines, mechanical equipment, and other outdoor maintenance and service facilities must be screened by walls, berms, or landscape from other Lots or Parcels, streets, or public spaces.

2.14 GOLF COURSE LOTS OR PARCELS

Golf Course Lots or Parcels may be required to have fences or walls along the Golf Course boundaries if required by the Design Review Committee. All fencing on Golf Course Lots or Parcels along the boundaries adjacent to the Golf Course shall be located, constructed, and maintained in accordance with specifications established by the Design Review Committee for the purpose of preserving and protecting the views of adjoining land from the Golf Course.

These fences shall be low masonry walls with wrought iron fencing, in a combination approved by the Design Review Committee. Owners of Golf Course Lots or Parcels, prior to installing fences or walls, or prior to modifying fences or walls existing on a Golf Course Lot or Parcel, shall obtain written approval regarding the location thereof and any such construction of modification from the Design Review Committee.

Any portion of a Golf Course Lot or Parcel, which is visible from Neighboring Property, shall be kept neat, clean, and free of weed and residue. All Golf Course Lots or Parcels shall be landscaped and maintained in accordance with the rules and regulations established by the Declarant or the Design Review Committee. Such landscaping shall not be modified without prior approval of

the Design Review Committee, which Committee shall determine that such modification will not interfere with the view from Neighboring Property of that Lot or Parcel thus landscaped or of other Golf Course Lots or Parcels.

No temporary storage facilities, storage sheds, or any other temporary or permanent structures may be placed on any Golf course Lots or Parcels so as to be Visible from Neighboring Property or the Golf Course without the prior consent of the Design Review Committee.

2.15 SWIMMING POOLS

Swimming pools should be designed as being visually connected to the residence through walls or courtyards, and screened or separated from the Natural Areas or direct view of the Street or of neighboring properties. They must be constructed according to the City of Henderson Regulations.

2.16 TENNIS COURTS

Tennis courts are not allowed except in certain situations on large Lots or Parcels as approved by the Design Review Committee. Tennis courts should be fenced and sited for minimal visual impact from the street or from neighboring properties. The construction of tennis courts below grade helps to reduce the need for fencing. Lighting from tennis courts will not be permitted to spill onto adjacent property, and no tennis court lighting shall be installed without the approval of the Design Review Committee.

2.17 LOT OR PARCEL RESTRICTIONS

No more than one Residence may be constructed on any Lot or Parcel.

The MacDonald Highlands design guidelines permit one accessory structure per design-accepting lot (i.e., larger lots) provided it complies with design requirements and restrictions per City of Henderson building code. Please be advised that a detached guesthouses, guest suites and/or cabana that includes a kitchen is not permitted in the City of Henderson (City of Henderson Ordinance No. 1295, Section 1.BN.2, adopted March 17, 1992). Any approved accessory structures should be designed as a single visual element, compatible with and complimentary to the design and form of the main residence, and should be visually connected by walls, courtyards, or other major landscape elements. The accessory structure must be contained within the building setbacks, shall be located to respect the views, privacy, and other aspects of adjacent properties, and the use of mature landscaping is encouraged to soften the appearance of these structures. No accessory structure may be leased or rented separately from the main residence. Requests for accessory structures must first be submitted to the Design Review Committee for review and approval, prior to submission to the City of Henderson for plans check and permit issue.

2.18 SIGNAGE STANDARDS

2.18.1 Introduction: It is the design intent of the signage for MacDonald Highlands to act as a unifier between the desert, the landscape, and the project's architecture. Signage will be subtle and blend into the site and its natural forms. Overall Site Signage has been designed to accomplish this goal. The Design Review Committee shall review and approve or reject all signage for conformance and appropriateness prior to any fabrication/installation taking place. In addition, all signage shall comply with the minimum standards as established by the City of Henderson sign ordinance and MUTCD and COH standards.

2.18.2 Theme/Materials: The signage concept is an understated, natural look to reflect the quality of the MacDonald Highlands project. The design theme for signage is based on the established architectural character along with the indigenous land forms that make up its natural beauty. Signage will have a horizontal character, blending elements found in the hills, stone, and native desert landscape.

Graphics on the signage will be etched into large stone slabs, which will identify individual streets, provide direction, and locate community amenities. The base of these stone slab signs will be enhanced with boulders, stones, and plantings in a variety of sizes and types to conform to the natural setting. The boulders at the base of the signage will also be useful in screening light fixtures from view. Colors on the signage surfaces will

incorporate the range of sands, tans, ochres, and terra cottas found in the surrounding desert hills.

Graphics will be etched in the stone slabs and colored for visual impact. Coloring of such signage is to be consistent throughout the development.

- 2.18.3 Letter Style:** Letter style for all common Overall Site Signage will be established by the Developer and the style, family, and weight shall be consistent throughout the development. Letter spacing is to be adjusted for the various uses to insure proper readability.

Developers will be able to use their own established letter style with the approval of the Design Review Committee. Letter style for Traffic Control Signs will conform to MUTCD standards as directed by the City Traffic Engineer.

- 2.18.4 Primary Entry Monumentation:** Integrated into the oasis entrance features, the Primary Entry Monumentation will act as an invitation to the MacDonald Highlands community and set the tone for secondary entry monumentation and subsequent site signage. The entry signage will be a wall capped with a pre-cast "Spanish" cap and constructed of flagstone or a similar material turned on end with the thin edge facing out. Metal letters depicting the MacDonald Highlands logo will be fastened so as to stand out from the stone entry wall.

- 2.18.5 Directional Signage:** Signs needed to direct traffic will be single-sided and located in the right-of-way at various intersections.
- 2.18.6 Secondary Directional:** Single- or double-sided signs will be used to direct traffic at major intersections and decision points. They may contain resort, residential, and amenity names, and will be located in the right-of-way around the site.
- 2.18.7 Street Signs:** In custom residential areas and along Stephanie and MacDonald Ranch Drive, the boulder signage theme, as described in Section 2.18.2 Theme/Materials, shall be placed at each intersection to identify street names.
- 2.18.8 Traffic/Regulatory Signs:** Traffic signs maintain and control proper traffic flow throughout the site. Locations, mounting heights, and size specifications will comply with MUTCD standards and are subject to approval of the City Traffic Engineer.

The sign panel will be manufactured of dimensional fabricated metal with front painted per DOT standards and edges stained or painted. The signpost will be fabricated metal that has been stained or painted. Lettering will be retro reflective die-cut vinyl per and meet high intensity type III or better standards per MUTCD.

2.18.9 Temporary Project Development Signs: Single- or double-sided signs identifying MacDonald Highlands, the Developer, Architect, Contractor, and any other pertinent information while the project is under construction will be located at the entrance to MacDonald Highlands at the intersection of MacDonald Ranch Drive and Stephanie Street.

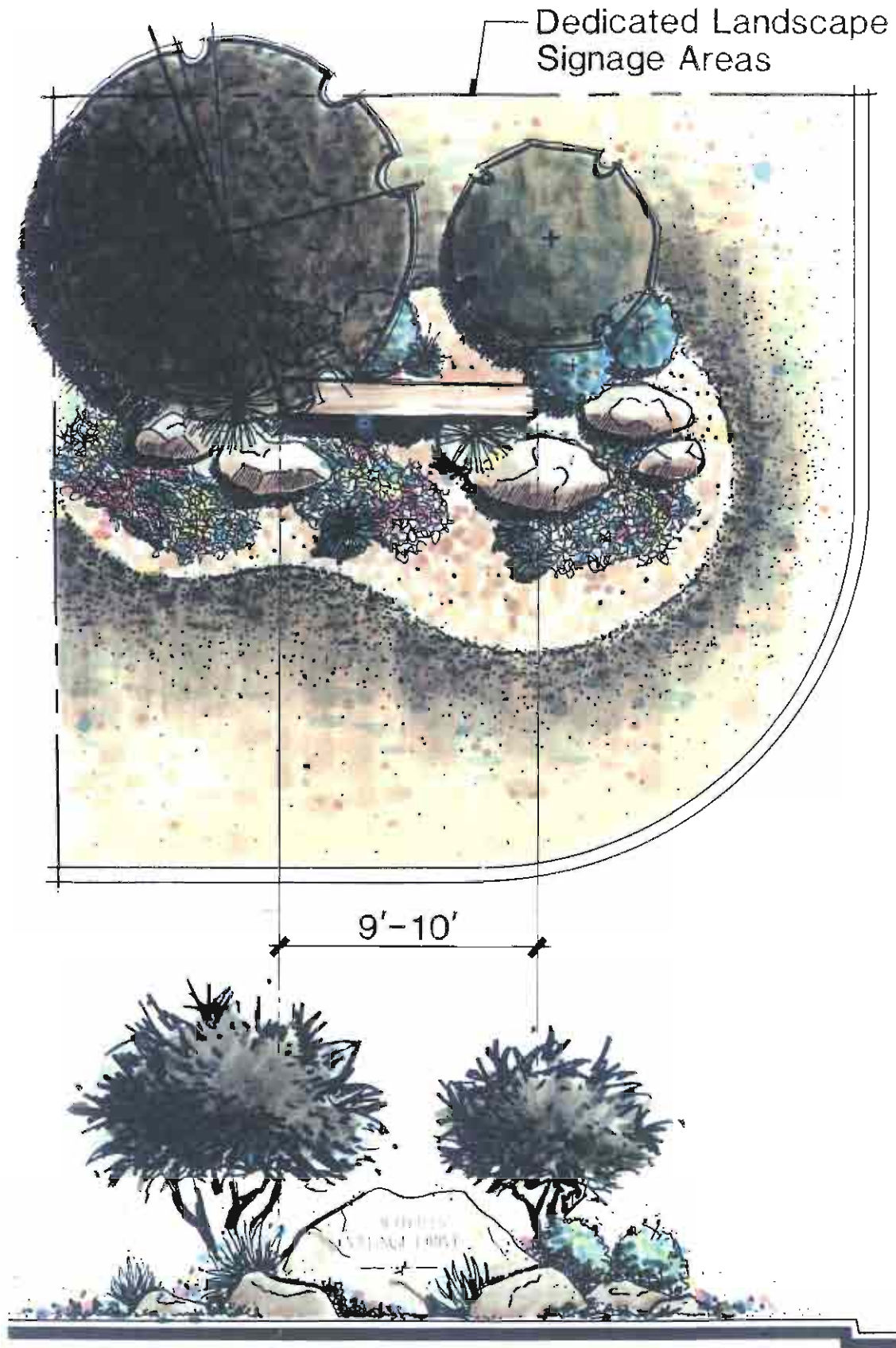

Street Signage at Intersection

Split Sandstone Boulder With
Sandblasted "Optima" Style Letters

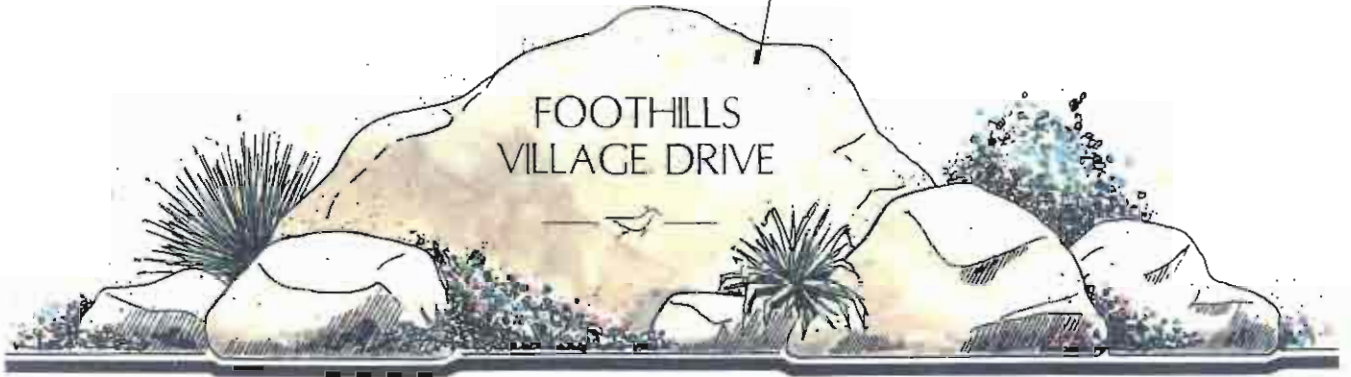

Street Signage Detail

3.0 ARCHITECTURE GUIDELINES

3.1 INTRODUCTION & GENERAL PRINCIPLES

3.1.1 Architectural Theme: Desert Elegance Aesthetic

The architectural character of MacDonald Highlands draws from diverse images to create a unique concept for the community. This character is simply titled “Desert Elegance Architecture.”

Desert Elegance indicates homes that complement the natural environment of the desert. MacDonald Highlands adds breathtaking city views and challenging sloped home sites to this ideal.

Simple forms and the use of natural materials dominate this form of architecture. These forms provide a tasteful backdrop to the natural desert landscaping surrounding the homes and the community in general. Low hip and flat roofs top the varied massing elements in each residence. Exterior materials such as stone and slate and earth tone colors respond to the hues and textures of the desert.

Shaded courtyards and patios provide a transition between the landscaping and the interior of the homes. Dramatic views are brought to the interior through large, shaded windows.

These concepts come together to create a community in harmony with its desert environment.

3.1.2 Pool & Spa Criteria and Hardscape Setbacks

All recreational pool and spa waterlines must be setback a minimum of five feet (5') from all property lines when visible from common open space and the golf course. If not visible, City of Henderson minimum setbacks shall apply.

Hardscape elements must be setback a minimum of three feet (3') from all property lines when visible from common open space and the golf course. Hardscape elements within side and rear yards on interior/non-visible lots shall conform to City of Henderson setback requirements.

Pool equipment shall be setback a minimum of five feet (5') from all property lines and shall not be mounted to a shared property wall, must not be visible from neighboring properties, streets, or community open space, and must be enclosed by wall with a gate or other suitable screening method.

3.1.3 Walls

The design and use criteria for the different types of walls to be constructed in the MacDonald Highlands community has been addressed in Section 2.10 of these Design Guidelines.

The architectural considerations of the design should be such that they comply with the community's Desert Elegance theme as well as the community concepts of openness and view preservation.

The exteriors of masonry wall sections shall be designed and constructed of natural materials that complement the colors, tones, and textures of the native desert environment.

The designs for the metal components of the view walls shall be ornate, shall convey the Desert Elegance theme, and shall remain open to preserve the views.

3.1.4 Service Areas & Utility Entrance Locations

Service yards are intended primarily for storage of trash, firewood, maintenance tools, etc. Minimum six-foot (6') high masonry walls are required around service yards. Pool, air-conditioning, irrigation, and other mechanical must be located underground or completely screened from view from adjacent lots, streets, or open space areas by a wall at least 12" higher than the equipment being screened within and must be setback a minimum of five feet (5') from all property lines.

Electric meters and panels, gas meters, sub-panels, telephone and television panels, etc. must be as much as possible out of sight when viewed from the golf course, street, or adjacent lots. All utility meters and panels must be painted to match the adjacent building color at which they are located or must be located in service yards, mechanical rooms, or within meter closets. Utility panels in excess of 400-amps require a closet, which is to be integrated into the design of the residence. Executive Estate Lots requiring electrical panels in excess of 400-amps require prior Nevada Power Company written approval to ensure electrical needs for the residence are attainable. Said approval shall be included as part of the schematic plan submittal package.

The interior of enclosed service yards must not be visible from the street, golf course, or adjacent properties.

3.1.5 Easements

Public utility easements and drainage easements are generally located along front, side, and rear lot lines. Areas reserved for such easements are specified and identified on the recorded map for the parcel or subdivision. This area has been established as an easement area for utilities, but it is the responsibility of the owner to landscape and maintain this easement area.

Each lot is served with underground electricity, gas, TV cable, and telephone. This location of these utilities within the easement should be confirmed in the field when a topographic survey of the lot is done.

Nevada State Law requires that prior to any construction all utilities must be located and marked. It is the responsibility of the property owner and contractor to make sure all utility companies have been notified so they can provide the required utility locations. A free service is provided to accomplish the required notifications to the utility companies. This service can be contacted by calling 1-800-227-2600 "Call Before You Dig."

All utility company pull boxes, transformers, etc. have been set within the easement in a manner that will accommodate future planting and grading to diminish their visual impact. They shall be leveled and graded around to provide positive drainage.

3.1.6 Exterior Elevations

The design elements of a customhouse shall be compatible and complimentary to each other, and must be sympathetic to the desert environment. Exterior treatments shall be consistently detailed around the entire house.

3.2 DESIGN CRITERIA - CUSTOM HOMES

[Planning Areas 1-Phase I, 3, 4, 5A (Highlands I), 5B, 5C (Highlands II), 6, 7, 8A, 10, 12, 15, 16, 18, 26, Palisades Unit I & Palisades Unit II]

Introduction

The goal for developing the architectural theme of MacDonald Highlands is to project a harmonious image and a distinctive identity. This should be achieved not by dictating a particular style but encourage a blending of styles emphasizing simple, strong masses and forms.

The purpose of these Architectural Standards is to provide guidance for the Lot Owner and architect. The maintenance of high architectural standards protects and enhances real estate values at MacDonald Highlands. The restriction of unsightly construction also helps to ensure that the image of a prestigious community is maintained. All proposed construction shall comply with the following general criteria:

- Is the residence compatible with a prestigious, high-quality image?
- Will the proposed residence maintain the character of the community?
- Does the residence seem appropriate to the concept of the community?

MacDonald Highlands is planned as one of the premier luxury communities in the United States. The community's incomparable setting, featuring majestic and rugged topography with expansive golf course amenities, and proximity to one of the country's most unique destination resorts, require an unparalleled unity and excellence in design, architecture, and landscape.

MacDonald Highlands has created a uniquely strong architectural image. The Design Review Committee's purpose is to ensure that the entire project is developed as originally envisioned. The Design Guidelines are intended to supplement existing City and County ordinances. The objectives of the Design Guidelines are to encourage and foster careful design so there is harmony between the homes, their sites, and the golf course, desert environment, and overall image. Emphasis is placed on utilizing the Owner's property to its fullest potential within the Design Guidelines. To accomplish these objectives, the following considerations must be understood and accepted:

- The design, review, and processing of each residence will be subject to direction and approval of the Design Review Committee. The review and approval process and Design Guidelines will ensure continuing high quality and compatibility of design within the custom lots and overall framework.
- The Design Review Committee and Design Guidelines are intended to enforce reasonable controls concerning various aesthetic considerations for MacDonald Highlands. These controls are not meant to duplicate or supersede the functions normally provided by public agencies, but rather to coordinate and direct the design and construction of the custom lots with different architects, landscape architects, engineers, contractors, and their owners, so as to achieve a pattern of quality and outstanding character.

The forms and materials should provide a response to the need to provide shelter from the sun with large overhangs to shade windows, mixed colors for reflection and blending, and covered porches to provide shaded outdoor areas.

It is the intent of these Design Guidelines to establish a consistent architectural theme for MacDonald Highlands, while allowing for flexibility of design expression.

To be part of the planned community of MacDonald Highlands, it is necessary for the residence to conform to certain general planning standards, which are as follows:

- All custom homes in MacDonald Highlands must be designed by professionals licensed in the State of Nevada (i.e., a licensed architect, licensed residential designer or licensed contractor with draftsman employees). Owner/Builders are no longer allowed.
- All residences must be well-constructed of quality materials. Additions must be consistent in design and quality with the original structure.

3.3 SITE PLANNING CRITERIA – CUSTOM HOMES

[Planning Areas 1-Phase I, 3, 4, 5A (Highlands I), 5B, 5C (Highlands II), 6, 7, 8A, 10, 12, 15, 16, 18, 26, Palisades Unit I & Palisades Unit II]

Introduction

The natural topography, vegetation and setting of MacDonald Highlands create a unique environment, which requires careful attention throughout the site design and development process. The integrated design of site and residence is crucial to ensure that the dwelling blends harmoniously into the surrounding desert landscape. The design must fully analyze the unique physical characteristics of the lot, including topography, slope, view, drainage, vegetation, and access.

The desert landscape is a fragile environment, and may take many years to naturally recover from the impacts of disturbances related to site development. In order to minimize these impacts, MacDonald Highlands along with the City of Henderson, have developed the criteria within this Supplemental Design Guidelines manual to protect the natural desert character of the community.

3.3.1 Building Envelope

The Building Envelope is the portion of the lot, exclusive of any setbacks, easements or other encumbrances, upon which lot improvements may be located. All lot improvements, including residential structures, accessory buildings, outside patios and terraces, tennis courts, swimming pools, and other site elements, must be designed within the Building Envelope.

A maximum Building Envelope has been established for each custom lot to foster creative solutions to the massing of building components and to ensure the preservation of views from each residence in MacDonald Highlands. The Building Envelope is based upon the minimum setbacks as outlined in Table 3.9, and the building height limit as described in Section 3.4.

It is not intended that the design of the residence completely fill the Building Envelope. Although the shape and location of the Building Envelope are intended to be somewhat flexible, only the Design Review Committee can make modifications to the Building Envelope only if the modifications do not result in a significant adverse impact upon the natural features of the lot, adjacent lots or the MacDonald Highlands community as a whole. Designs, which in the opinion of the Design Review Committee overwhelm the Building Envelope, will be considered inconsistent with the philosophy of MacDonald Highlands and will not be approved.

3.3.1.a Combined Lots

If an Owner owns two contiguous Lots and wants to combine the two Lots into a single homesite, the Owner may do so only with the prior consent of the DRC and only if the change, in the DRC's opinion, does not materially impair views and/or privacy from neighboring Lots or Common Areas. When considering combining Lots, the Owner must recognize that combining two Lots or Building Envelopes may be beneficial, as it could provide more Open Space between adjacent Lots and improve view corridors; it may also have an adverse impact on the views and privacy of other nearby Lots or Common Areas, and should be reviewed carefully by the DRC. An Owner may apply for a variance on a front yard setback based on specific Lot configurations subject to DRC approval. The Owner or his representative is urged to submit a proposed revised Building Envelope for Combined Lots as early in the design process as is reasonable prior to preliminary submittal. Specific focus will be placed on, but not limited to the following:

**SITE PLANNING CRITERIA – CUSTOM HOMES
MINIMUM SETBACKS***

	LOT SIZE	FRONT	SIDE	REAR
Compound Estate: Planning Area 13	1-3 Acres	25'	15'	35'
Manor Estate: Planning Areas: 5B and 12	1 Ac.	25'	15'	35'
Manor Estate: Lot 3-PA5B	1 Ac.	50'	15'	35'
Manor Estate: Planning Area 10	1/2 to 1 Ac.	25'	15'	35'
Hillside Estate: Planning Areas: 6, 7, 18, 26, Palisades Units I and II	1/2 Ac.	25'	15'	30'
Golf Estate: Planning Areas: 1- Phase 1, 8A, 15/16	1/2 Ac.	25'	15'	30' **
Executive Estate: Planning Areas: 3, 5A and 5C (Highlands Units I and II)	1/3 Ac.	25'	10' Corner Side One-Story: 15' Corner Side Two-Story: 20'	30' **

* Accessory structures provided on interior lots must be setback a minimum of five feet (5') from all property lines. While accessory structures provided on lots along the golf course and/or common open space must be setback a minimum of ten feet (10') from all property lines, except for storage structures, which shall not be allowed along the golf course, common open space and hillside areas.

** Single-story elements, including but not limited to patios, sun decks and "open" balconies may encroach 10'-0" maximum into the rear setback on Executive and Golf Estates, however, must comply with minimum side setbacks.

- Adjustments in Building Envelope
- Preservation of view corridors
- Building height restrictions
- Architectural massing

The plat for a newly configured single Lot must be approved by the City of Henderson, Nevada and must be recorded. All expenses associated with recording the new Lot and pursuing any required governmental approvals are the responsibility of the Owner.

3.3.2 Natural Area

The natural area is the portion of the lot that lies outside of the Building Envelope, and must remain in its natural desert condition. Additional plant material may be added in the Natural Area subject to approval by the Design Review Committee. If approved, only plants indigenous to the general area of development may be used, and the density and mix should approximate that of the surrounding desert landscape. Irrigation of the Natural Area is not permitted since the indigenous vegetation does not require additional water. Irrigation of the Natural Area can lead to disease and demise of the native plants, and contribute to the spread of undesirable plant species or weeds.

Lot Owners in Planning Area 7 and Planning Area 5B shall be required to prepare a legal description of Natural Area that cannot be amended without Design Review Committee approval.

Any slope area adjacent to the golf course and not a part of the area of home development or construction shall be landscaped as a "Natural Desert Zone" or "Natural Area".

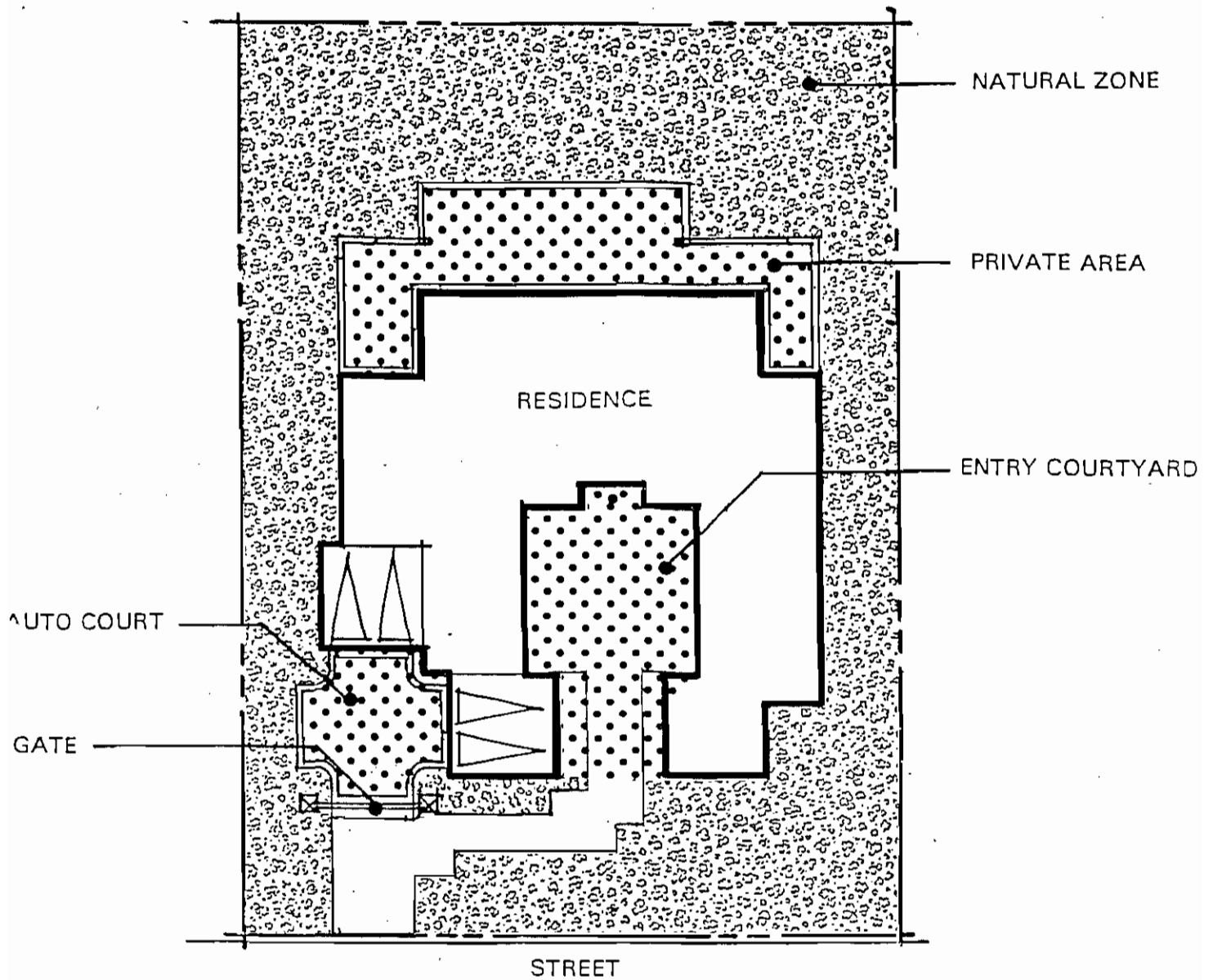

Note: The exact location of the Natural Area may vary from lot to lot, based in part upon topography and specific site conditions.

CUSTOM HOMES – NATURAL AREA

Exhibit "R"

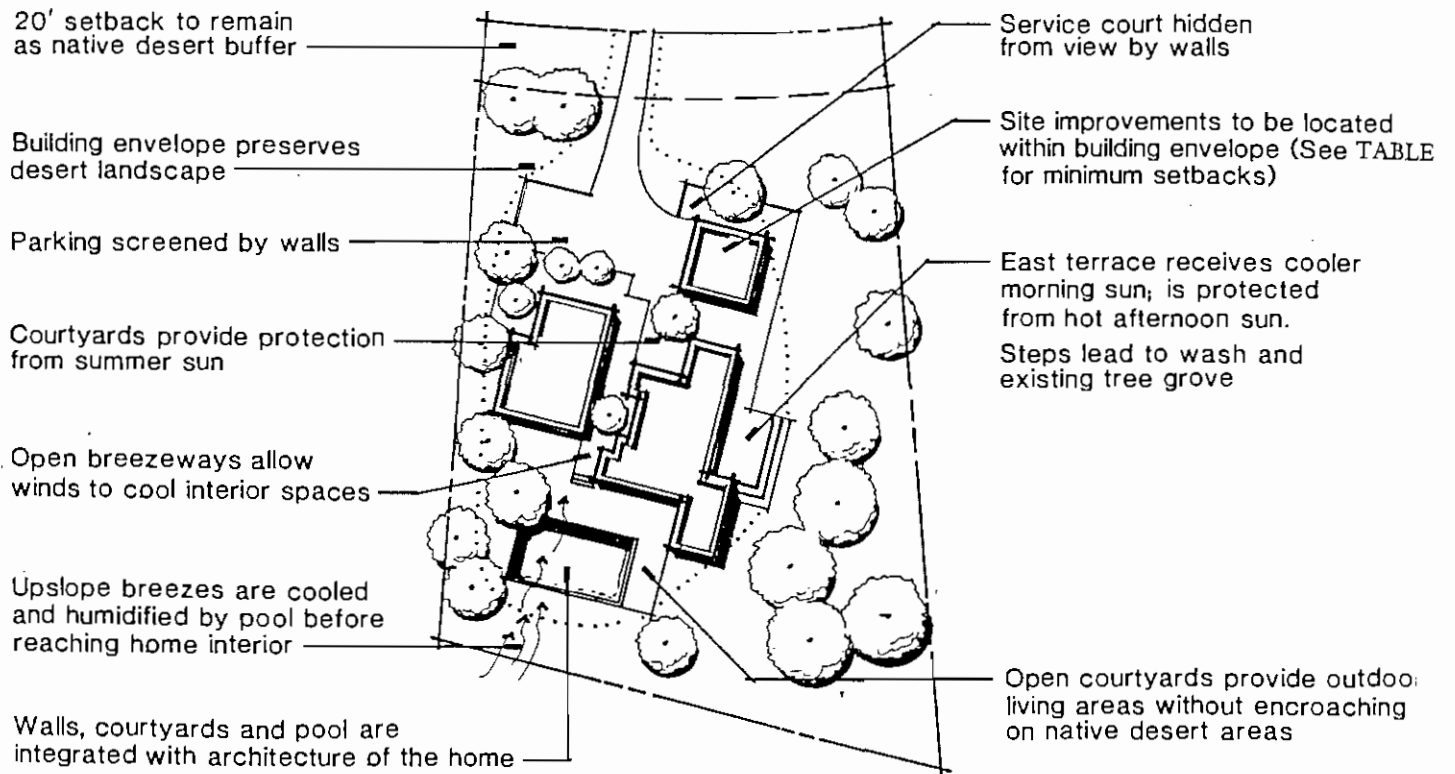

RESIDENTIAL ILLUSTRATIVE SITE PLAN

Exhibit "S"

3.3.3 Private Area

The Private Area is the portion of the Building Envelope that has limited visibility from neighboring properties because it is screened from view by plant materials, walls or other structures. The Private Area is the least restrictive in terms of plant selection, and may include any plant material listed on the Approved Plant List, or subject to Design Review Committee approval, any other plant material not included on the Prohibited Plant List.

3.3.4 Building Orientation

The custom lot areas within MacDonald Highlands have been designed to provide a sense of exclusivity to each of the neighborhoods. This exclusivity is further achieved through the ample sizing of individual lots to enable the creation of a pleasant neighborhood character with an emphasis on one-story homes and significant space between residences. The siting of individual structures on the lot should consider the following three primary factors: 1) Solar Orientation; 2) View Orientation; and 3) Relationship to adjacent lots and the overall community. The Design Review Committee will consider each lot independently, and will give extensive consideration to view corridors, impacts on adjacent homes, solar orientation, drainage patterns, impacts to existing site conditions, and driveway access.

3.3.4.a Solar Orientation: The desert climate is characterized by extreme conditions ranging from intense heat in the summer to very cold temperatures in winter. Passive solar design techniques are encouraged in order to minimize summer heat gain while maximizing heat gain during winter months. The placement of windows is of particular importance in relationship to solar orientation. Windows with direct sun exposure should

be shielded by covered patios, wide overhangs, shade structures, tinted glass or other similar devices, to minimize the effects of the sun.

The use of solar panels, hot water storage systems, or other similar devices shall not be visible from any street or community open space, and are subject to approval by the Design Review Committee.

3.3.4.b View Orientation: The hillside character of MacDonald Highlands provides spectacular view opportunities for most of the lots throughout the community. The orientation of the residence's major rooms, patios and terraces should be designed to take advantage of these dramatic views. The use of large picture windows and corner glass are especially effective in capturing the views offered by the site, and are characteristic of the Desert Elegance style of architecture.

With the golf course orientation of MacDonald Highlands, there is an inherent risk that golf balls and the play of golf may impact lots or residences with golf course frontage. The Design Review Committee strongly recommends that, during the planning of site improvements on your lot, careful consideration be given to the possibility of errant golf balls, particularly regarding the orientation of windows or other breakable surfaces of the dwelling. Netting, screens, excessive landscaping, fences or large blank walls will not be allowed. Evaluation of the proper siting, orientation, massing and setbacks should provide for maximum golf or view orientation with minimal adverse impact from the play of golf. Design consideration should also be given to the noise generated by golfers, golf carts and maintenance vehicles.

3.3.4.c Relationship To Adjacent Lots & The Overall Community: Residential structures should be designed to blend into the overall character of the desert environment as much as possible, minimizing any negative visual impact from surrounding areas. The design of individual homes should carefully consider the scale, proportion, and massing of building elements to ensure the resulting structure is compatible with the overall philosophy of MacDonald Highlands.

It is the intent of these guidelines to ensure that not only are the architectural designs consistent with community standards but that each new home compliments and enhances those homes that already exist. An important aspect of the MacDonald Highlands philosophy is the goal of having the home fit within the existing terrain and not reconfigured the terrain to fit within the home. Careful consideration of the surrounding site conditions should be designed as an integral element of the lot's development. Therefore, the Design Review Committee will require all Lot Owners to provide the Design Review Committee with lot cross-sections as shown in Exhibit "V". In addition to presenting the proposed elevations of the home, the cross-section must depict the proposed contours carried out to the lot lines.

Furthermore, if adjacent lots have existing homes, the Lot Owner is to show the existing homes and its elevation in relation to his/her proposed design. Elevation data from adjacent lots will be made available to the Lot Owner by the Design Review Committee upon request. Cross-sections are to be included in the Schematic Plan Review Submittal.

The building setbacks specified in Table 3.9 are minimum requirements. It is strongly encouraged for the design of individual homes to incorporate additional setbacks, where appropriate, to further enhance the character of the neighborhood and to increase the distance between residences on adjacent lots. The use of additional setbacks may be applied to certain lots to ensure specific siting issues are appropriately considered.

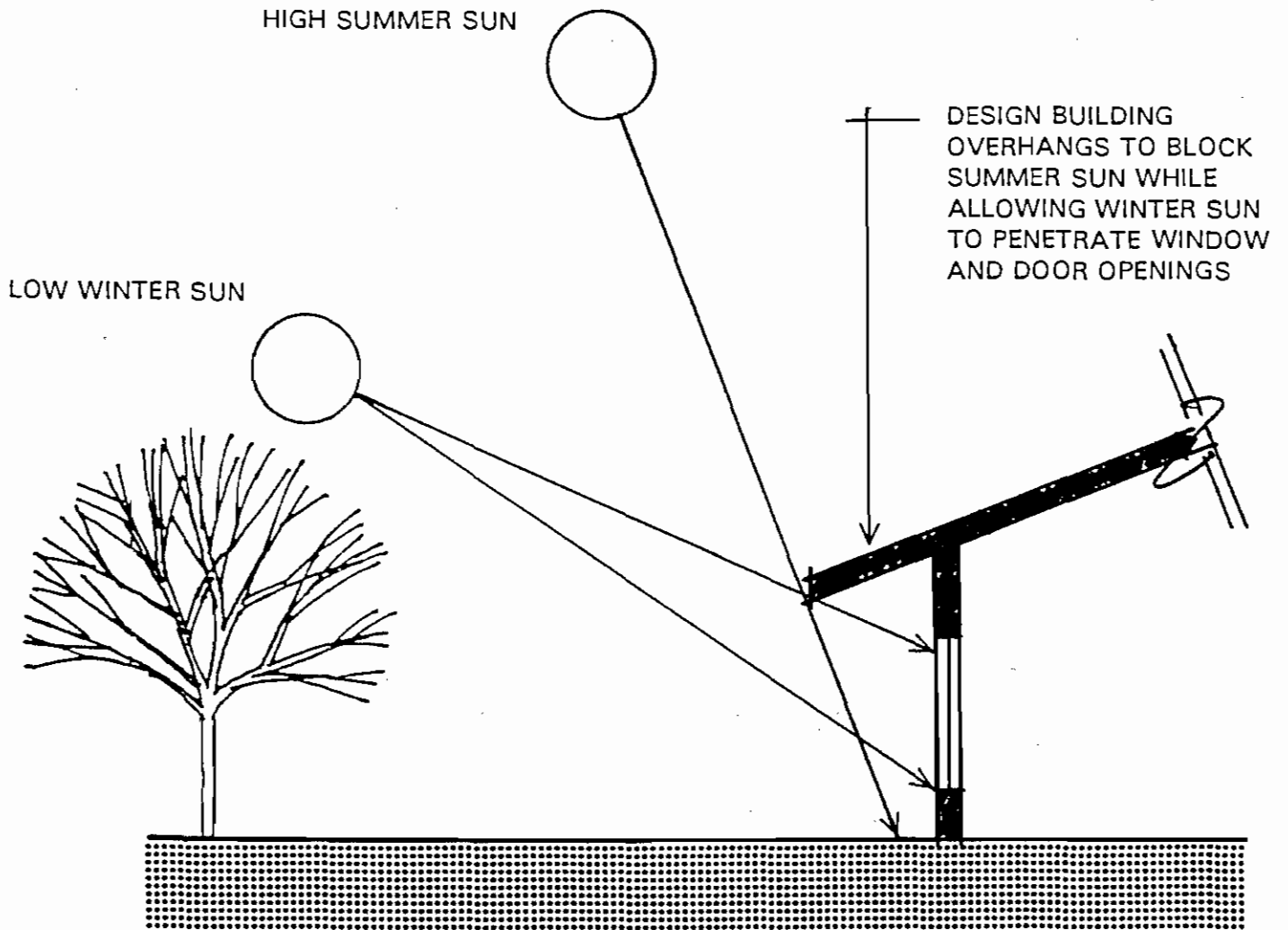

CUSTOM HOMES – SOLAR ORIENTATION

Exhibit "T"

ORIENT LIVING SPACES TO DOMINANT VIEW

ARTICULATE REAR BUILDING FACADES AND ELEVATIONS TO ENHANCE VIEW FROM COMMUNITY OPEN SPACE

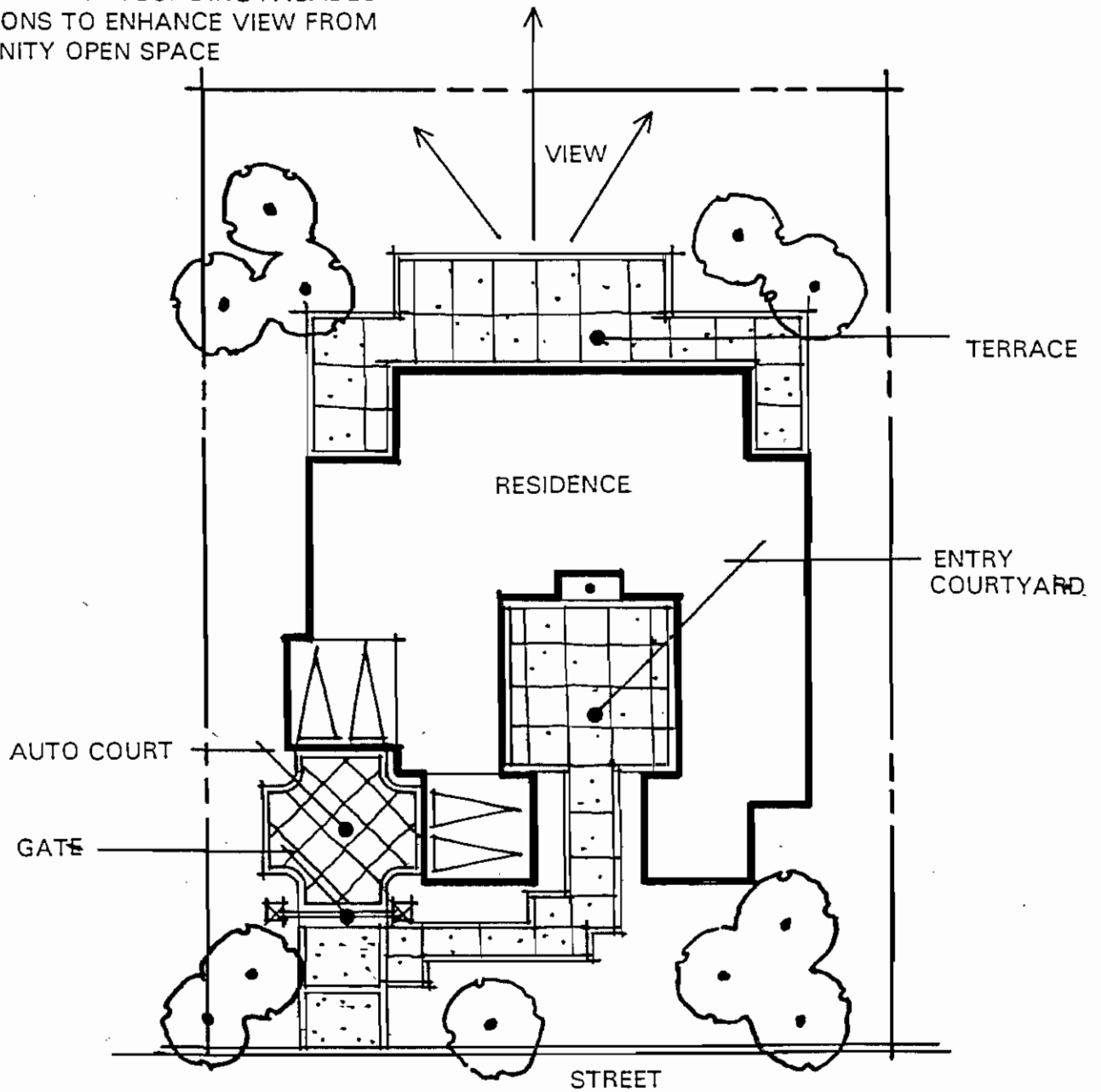

CUSTOM HOME – VIEW ORIENTATION

Exhibit “U”

MacDonald Highlands Required Lot Cross Sections

Hillside Planning Areas Only

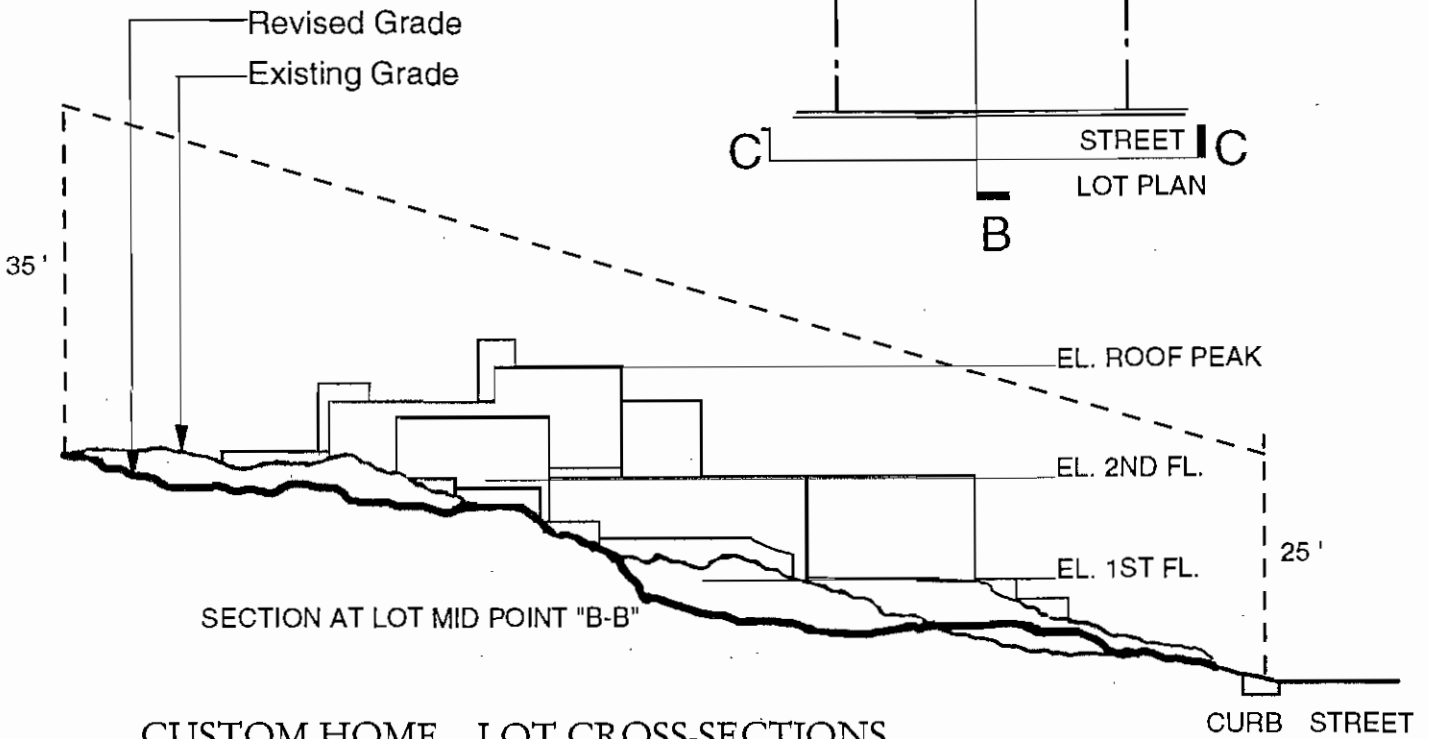
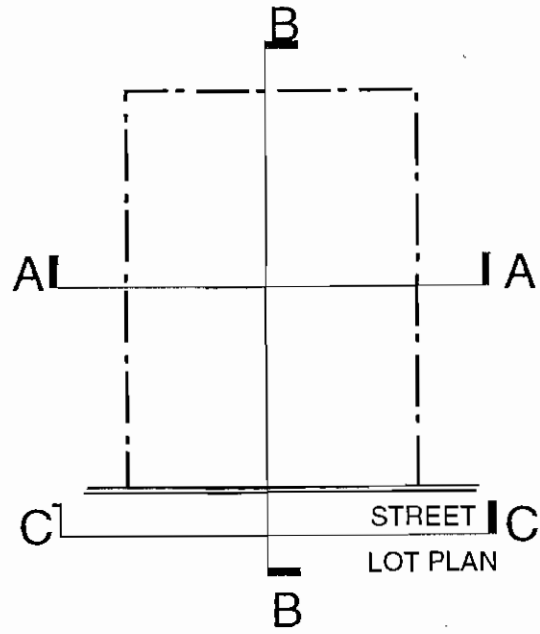
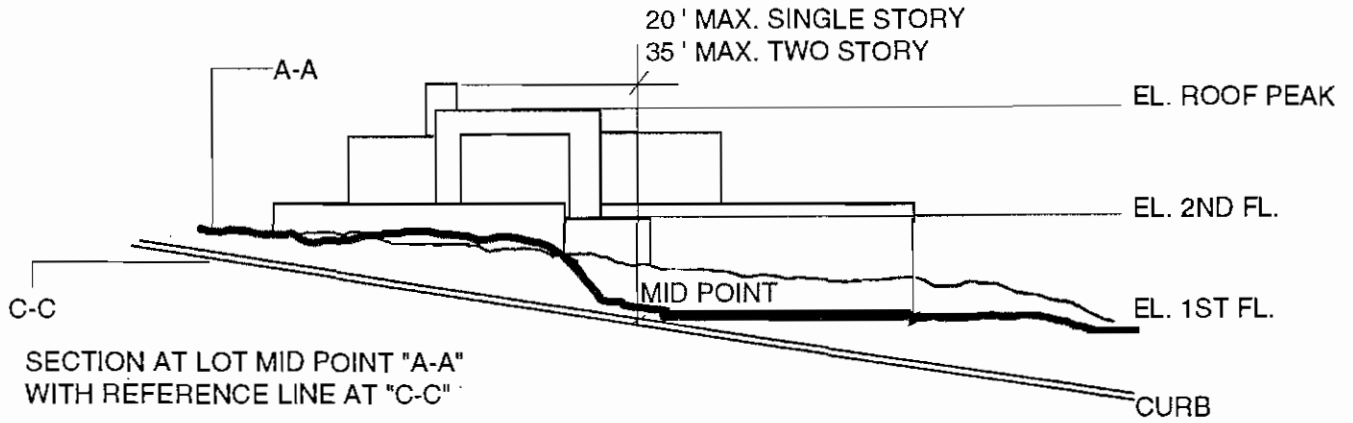

CUSTOM HOME - LOT CROSS-SECTIONS

3.3.5 Driveway And Parking Criteria

3.3.5.a Driveway Location: Driveways should be located in a manner that minimizes their visual impact on significant natural features of the lot, such as vegetation, washes or drainage ways. Driveways should also be located such that there is no interference with drainage in the street right of way. Each custom lot may have up to two driveway entrances as further described below.

3.3.5.b Maximum Width Of Driveways:

- Single-car garage driveways must not exceed 15' in width at the curb.
- Two-car garage driveways may not exceed 20' in width at the curb.
- Three-car garage driveways (i.e., 2-car + 1-car) may not exceed 30' in width at the curb.
- Three-car garage driveways (i.e., 3-individual garage doors) may not exceed 35' in width at the curb, provided landscape pockets along each of the garage bay offsets are offered.
- Dual-entry driveways (a.k.a. circular or carriage driveways) may not exceed 20' in width at the curb *per entrance*. Also a 36' minimum separation, as measured from centerline to centerline, is required on all dual entry driveways.

Adjustments to any and all driveway conditions may be considered on a case-by-case basis at the sole discretion of the Design Review Committee.

- 3.3.5.c Minimum Length of Driveways:** The minimum length of a driveway as measured from the property line to the face of the garage is 25'.
- 3.3.5.d Driveway Setbacks from Side Property Lines:** Driveways and parking areas within the front yard setback must be a minimum of 2' from the side property line.
- 3.3.5.e Driveway Materials:** All driveways are required to be patterned concrete, stone, brick, Bomanite, or other similar textured paving materials. The color of driveway materials must be compatible with the guidelines outlined in Section 3.4.5. Ordinary concrete without color or textural embellishment will not be allowed.
- 3.3.5.f Garage Placement:** It is encouraged for garage doors to be out of view from streets or other public spaces. This can be accomplished by the creation of auto courts and side entry garages; or the screening of garage doors through the use of screen walls and other landscape material.
- 3.3.5.g Parking Spaces Required:** Each custom residence must provide at least five off-street parking spaces. A minimum of two of these spaces must be in an enclosed garage, either attached or detached from the main residence. Carports are not permitted, except where enclosed on three sides and made an integral part of the structure. On-street parking is limited to visitors and guests only. Due to City of Henderson Fire Code, on-street parking is limited to one side of the street only. The approved street parking for visitors and guests will be limited to the southside and the eastside of the street

only (per MacDonald Highlands Master Association Rules and Regulations adopted July 10, 2002). Views of guest parking areas from adjacent lots, streets, or public spaces must be minimized by depressing them, using screen walls, or landscaping or a combination of these. Screen walls should be a maximum 6'-high (per City of Henderson requirements). Landscape berms may also be used, however, their slope and contour must blend naturally into the surrounding landscape. No exterior storage of recreational vehicles or boats will be permitted.

- 3.3.5.h Repair of Damages:** It shall be the lot owner's responsibility to repair existing streets, curbs, sidewalks, utilities, neighboring lots, or other existing elements, which may be damaged as a result of construction activity on the owner's lot.

3.3.6 Site Amenity Standards

- 3.3.6.a Accessory Structures:** All accessory structures, such as gazebos or trellis structures, are to be reviewed and approved by the Design Review Committee prior to construction.

Accessory structures provided on interior lots (i.e., fully-enclosed/non-visible lots) must be setback a minimum of five feet (5') from all property lines. While accessory structures provided on lots along the golf course and/or common open space must be setback a minimum of ten feet (10') from all property lines, except for storage structures, which shall not be allowed along the golf course, common open space and hillside areas.

The height of an accessory structure will be reviewed by the DRC on a case-by-case basis as it impacts neighboring properties, the golf course and common open space.

3.3.6.b Swimming Pools: Swimming pools should be designed to visually connect with the residence through the use of walls or courtyards, and must be screened from direct view of the street, natural areas, or neighboring properties. They must be constructed according to the City of Henderson Regulations and other applicable regulations, including required fence and enclosure heights. Doors and gates leading to swimming pools and spas must meet the City of Henderson safety and closure regulations including doors that open directly from the residence to any pool or spa area.

Pool backwash or pool draining is not allowed to be disposed of in the sanitary sewer system, nor due to environmental concerns, is it allowed to be disposed of into a wash or other natural drainage area. It is recommended that a dry well be constructed to allow for disposing of pools backwash and draining. Any applicable City of Henderson regulations governing disposal of pool water must be followed.

All recreational pool and spa waterlines must be setback a minimum of five feet (5') from all property lines when visible from common open space and the golf course. If not visible, City of Henderson minimum setbacks shall apply.

Hardscape elements must be setback a minimum of three feet (3') from all property lines when visible from common open space and the golf course. Hardscape elements within side and rear yards on interior/non-visible lots shall conform to City of Henderson setback requirements.

Pool equipment shall be setback a minimum of five feet (5') from all property lines and shall not be mounted to a shared property wall, must not be visible from neighboring properties, streets, or community open space, and must be enclosed by wall with a gate or other suitable screening method.

The color of exposed tile on a negative edge pool must blend with the surrounding landscaping and/or site features. No light or bright tile colors will be permitted.

Diving boards and slides may be permitted only by Design Review Committee review and approval. Swimming pools and spas added to a residence after plan approval must be submitted to the Design Review Committee or MacDonald Highlands Master Association, as applicable, for review and approval, prior to installation.

- 3.3.6.c Tennis Courts:** when approved by the Design Review Committee, must have a minimum 10' setback from all property lines to allow adequate landscape screening. Tennis courts desired on a golf course Lot must be constructed a minimum of 6' below grade (i.e., sunken) and the community-designed view fence or view wall must be constructed along the rear property line. When depressed, a lesser setback may be considered by the Design Review Committee depending upon the placement of the tennis court on the Lot and its impact on neighboring properties and common open space.

Mesh-coated chain link fencing may be considered by the Design Review Committee on a case-by-case basis, however, where approved, must be compatible with the

community iron color, "Foothills Mahogany" [Exhibit "L"].

Tennis court lighting may also be considered by the Design Review Committee on a case-by-case basis, provided a detailed lighting plan and manufacturer information for the proposed light fixtures are provided to the Design Review Committee for proper consideration. Lighting, where approved by the Design Review Committee, shall be located, directed and shielded so that light rays and glare do not extend beyond the lot boundaries.

3.3.6.d Sports Courts: The location of all hard and soft surfaced dimensioned sport courts, such as basketball, racquetball, volleyball, etc. are subject to review and approval by the Design Review Committee. All such courts must have a minimum of a 10' setback from property walls to allow for light fixture placement and landscape screening. Lighting, if installed, shall be located, directed and shielded so that light rays and glare do not extend beyond the lot boundaries.

3.3.6.e Exterior Recreational, Play Equipment and Pool Slides: All exterior recreational or play equipment such as swing sets, slides, play structures, jungle gyms, pool slides and other similar equipment must meet the intent and requirements of all sections of the Design Guidelines, including color. This type of equipment or structures should be located in the least visible portions of the lot and must not be visible from the golf course. In addition, such equipment or structures should be screened from view from adjacent lots through the use of mature landscaping or other screening devices. The

height of this type of equipment is limited to maximum of 8'-0" above finished grade. Due to the fragile nature of the desert environment, tree houses or other play structures attached to plant materials will not be allowed. All exterior recreational or play equipment requires specific approval of the Design Review Committee prior to installation.

3.3.6.f Basketball Hoops: Basketball hoops and backboards may be installed at any residence subject to prior approval by the Design Review Committee, and may be subject to stipulations imposed by the Design Review Committee based on specific review of the request. The basketball hoop and backboard must be removed when no longer utilized. The intent is to locate a basketball hoop and backboard in the least visible area and away from view from the street, golf course, or other public areas. Basketball hoops and backboards are not allowed in yards facing the street, nor on the face of a building that faces the street.

Backboards mounted on a building must be clear or painted to match the adjoining residence, and the top of the backboard must be below the top of the parapet of the wall on which it is mounted. No backboards are allowed on a pitched roof. Backboards mounted on a pole must be either clear, painted to match the house, or painted a flat verde green, or whatever color "blends in" in the opinion of the DRC. The pole or support shall be removable and must be painted the community paint color, "Foothills Mahogany" [Exhibit "L"].

The Design Review Committee may require additional mature landscaping to screen any basketball hoops and backboards from adjacent lots, streets and public areas. Although the general guidelines of this section may be

met by a proposed application, the Design Review Committee reserves the right to deny the request for a basketball hoop and backboard if, in its sole discretion, it determines that a negative impact would result.

3.3.6.g Address Identification: In an effort to provide consistency within MacDonald Highlands while conforming to its design philosophy, a distinct address identification device has been selected for the community. This device was chosen because it offers numerous options for glass and designer finishes, allowing flexibility to the Lot Owner to best match the design, materials and colors of his/her residence.

The specified address identification device is as follows:



Model#	Width	Height	Exl.
SPJ43-02A	11"	5 1/2"	2 1/4"
SPJ43-02B	14 1/2"	5 1/2"	2 1/4"
SPJ43-02C	18"	5 1/2"	2 1/4"

Shown: Aged Brass / Honey Iridescent

Model: SPJ43-02A
(3) # Address Light

Shown: Rusty / Frosted Seedy

Model: SPJ43-02B
(4) # Address Light

Model: SPJ43-02C (Not Shown)
(5) # Address Light

All Above:
Mounting: Flush Mount
Socket: (2) Single Contact Bayonet
Electrical: 12V
Lamp: (2) 13W Max.

Recessed & Custom Sizes Available!

SPJ Lighting, Inc.
Address Light Model #SPJ43-02
available through Nevada Sales Agency, Las Vegas
(702) 270-4181 Phone (702) 270-4196 FAX

Individual address identification devices for each approved residence shall be installed by the homeowner and such devices should be compatible in design, materials and colors with the residence.

No additional signage detached from the residence will be permitted. The Design Review Committee may require installation of uniform address identification devices for all lots, including lots with previously constructed identification devices.

3.3.6.h Exterior Lighting: The goal of MacDonald Highlands, to preserve the visual character of the desert environment, extends to nighttime as well as daytime conditions. In order to preserve the dramatic views of the city lights and the night sky, which tend to be obscured by excessive local lighting, the following guidelines have been established for residential site lighting. Site lighting is defined as lighting mounted to the any exterior surface of the residence, ground, trees, site walls, fences or any other site feature for the purpose of providing security, decorative accent or functional lighting to outdoor spaces.

All requests for exterior lighting, including landscape lighting, ***MUST*** be submitted to and approved by the Design Review Committee *prior to installation*. Below please find particular design requirements pertaining to site lighting:

- Site lighting located on the side of the residence facing the golf course is strongly discouraged. "Footlights" that are directed down and other down light fixtures that are mounted close to the ground

with minimal light output are best suited for this side of the residence.

- Subtle, low-level lighting of landscape areas is encouraged. Landscape lighting, however, shall not intrude or produce a glare onto adjacent lots, lots across the street, or onto any public space. Landscape lighting must be directed downward onto vegetation or prominent site features, and may not be used to light walls or building elements. All lighting must be directed toward the interior of the lot upon which it is located.
- Building mounted lighting must be directed downward away from adjacent lots, streets, and community open spaces, and may not be used to light walls or building elements for decorative purposes.
- All exterior lighting must provide for significant shielding to ensure that light sources and lamps are not visible from neighboring property; no bare lamps will be permitted.
- Recessed and soffit lighting in *entries, above garage door bays, and on patios and covered balconies* shall have a maximum wattage of 75 watts and the lamp must be recessed a minimum of 3" into the ceiling. Recessed lamps must also have a minimum 5' separation between fixtures.
- Lights in *exterior soffits and eaves* are not allowed, as they are not appropriate in the development of hillsides.

- Only incandescent lamps with a maximum wattage of 75 watts will be allowed for exterior lighting unless specific approval is received from the Design Review Committee. Low voltage lighting is recommended, since these fixtures are typically small and can be easily concealed within the vegetation. Colored lights will not be allowed for exterior lighting.
- No lighting will be permitted in the Natural Areas or outside areas not enclosed by patio or building walls. Site lighting must be confined to areas enclosed by walls or be in the immediate vicinity of the main entrance or outdoor living spaces of the residence.
- Tree lights are allowed, however, no chasing, twinkling or blinking lights are permitted.
- Lights on motion detectors ***MUST*** be submitted to and approved by the Design Review Committee *prior to purchase and installation*. When permitted these lights will only be allowed to operate on a motion detector and stay lit for a maximum of 20 continuous minutes. Security lights of any type or locations must still meet the requirement of shielding the light sources, and the light sources may not be visible from neighboring property. Special care must be taken to avoid setting off the detector by the motion of vegetation and the movement of wildlife. These lights will not be allowed to operate for the purpose of general illumination.
- If problems occur with ***any*** exterior lighting, the HOA and/or Design Review Committee reserve the right to require such fixtures be disconnected.

3.3.6.i Exterior Holiday Decorations:

The intent of this section is to ensure that exterior holiday decorations are compatible with the overall community image of MacDonald Highlands. They are not meant to discourage decorating during holiday periods. Holiday decorations should be tastefully subtle, and should not have a commercial appearance nor be "over done" in terms of brightness, size, or visibility from public spaces. The Design Review Committee reserves the right to prohibit any holiday decorations it deems inappropriate with the community image of MacDonald Highlands.

Decorations shall not be allowed to be mounted on roofs or located outside of the site walls.

No exposed spotlights will be allowed. Luminaries are allowed along driveways and patios, but not on roofs or parapets. Paper luminaries with candles are not allowed due to the potential danger of fire. Care must be taken that luminaries do not blow away or litter adjacent properties.

Christmas decorations are allowed to be displayed one month prior to and one month after the actual holiday. Decorations for other holidays may be installed no more than two weeks prior to the holiday and must be removed within one week after the holiday.

3.3.7 Hillside Design Criteria

3.3.7.a Neighborhood-Level Criteria: In comparison to relatively flat parcels, the design of a hillside neighborhood requires a different approach in order to ensure that development blends naturally into the hillside character of the site. Therefore, in the design of such hillside neighborhoods, the following criteria shall apply:

- **Water (Public Works):** Water System Design: All water systems shall be designed in accordance with the Uniform Design and Construction Standards for Water Distribution Systems, Clark County and the Uniform Standard Specifications for Public Works Construction, Clark County area.
- **Water (Fire Department):** Water System Flow: The water mains and the distribution system shall be designed to deliver a minimum residual pressure of 20 pounds per square inch (psi) at the fire hydrants in service during maximum day demand plus the required fire flow demand. Minimum fire flow shall be equal to 750 gallons per minute (gpm) for residential property classified as a Group R, Division 3 occupancy. All other occupancies shall be as prescribed by the Fire Code. The system shall be designed to provide a minimum of 40 psi during peak hour conditions without fire flow. A maximum pressure delivery at the point of service shall not exceed 120 psi.
- **Building Fire Sprinkler Systems:** All buildings shall be provided with an approved automatic fire sprinkler system in accordance with the Fire Code. The water

system design shall accommodate the requirements for building fire sprinkler systems. The building fire sprinkler system shall meet City of Henderson requirements, in addition to the Fire Code requirements.

(Based upon steeper road grades, reduced roadway design speeds, reduced roadway width, longer dead ends and cul-de-sacs, reduced water system design requirements and relaxed secondary access requirements, the response time for emergency vehicles is increased above that of conventional development patterns within the City of Henderson. Given the increased response time, a waiver of the requirement for building sprinkler systems is subject to review and approval by the Fire Marshal.)

- **Water Main Sizes:** Residential water main sizes shall be a minimum of 6 inches in diameter or as required by the City of Henderson Public Works Department. If minimum fire flow requirements are met, fire hydrant branch lines shall not be required to be looped.
- **Fire Hydrant Branch Lines:** Fire hydrant branch lines shall be set at right angles to street mains. The hydrant shall be set at the end of the branch line and shall face the branch. No horizontal or vertical bends or reducers shall be used in installing fire hydrant branch lines unless specifically approved by the City of Henderson. Under no circumstances shall any size or manner of tap be made on a fire hydrant branch line.

- **Fire Hydrant Location and Distribution:** The number and spacing of fire hydrants shall meet the approval of the Fire Prevention Division. Fire hydrants shall be located adjacent to and accessible from fire apparatus access roads. Fire hydrants shall be located along fire apparatus roads as follows:
 - Spacing of fire hydrants shall normally start by placing fire hydrants at all intersections or;
 - In all residential areas, fire hydrants shall not be spaced greater than 750 feet apart, or;
 - The maximum distance from a Group R, Division 3 Occupancy to a fire hydrant shall not exceed 500 feet, as measured from an approved point on a street or road frontage to a fire hydrant.
- **Wastewater Collection and Treatment:** Wastewater collection systems shall be designed in accordance with the Design and Construction Standards for Wastewater Collection Systems, Clark County, 1991 and the Uniform Standard Specifications for Public Works Construction, Clark County area. Septic systems shall not be permitted.
- **Drainage Design:** Drainage facilities shall be designed to maintain the natural run-off characteristics. Drainage facilities shall be designed in accordance with the Clark County Regional Flood Control District Hydrologic Criteria and Drainage Design manual. Private drainage facilities, cross lot drainage easements or rear lot drainage easements shall be privately maintained.

- **Roadways:** Within the hillside neighborhoods, all roadways whether public or private, shall be designed according to the standards described in Page 3.38, as well as AASHTO requirements. The standards are also intended to supplement the Public Works Department Plan Review Guidelines. Roadways should be located such that impacts to the natural environment are avoided.

Roadways should follow the topography of the area to minimize grading cuts and fills. Curvilinear horizontal alignments and gently rolling profiles consistent with the natural topography will minimize unnecessary site disturbance. Significant features such as rock outcroppings should be avoided.

- **Homeowners Association:** Each hillside development plan that provides for private streets or improvements, common areas or natural areas shall establish and maintain a Homeowners Association. The association shall be responsible for the maintenance and upkeep of all private streets and improvements as well as all common areas.

Natural areas may be designated as a deed-restricted portion of a privately owned lot, or as a separate parcel. Such parcel may be under the ownership of a homeowner's association or deeded to any organization, which accepts responsibility for the perpetual preservation and maintenance of the natural area, subject to approval and acceptance by the City of Henderson. To protect the natural areas, covenants that run with the land shall be recorded in

favor of the City of Henderson and of all owners with record interest in the natural area.

3.3.7.b Custom Lot Criteria

- **Site Design:** The sloping topography of a hillside lot, unlike a flat homesite, provides many challenges as well as opportunities. While hillside lots offer dramatic view opportunities, they are also highly visible elements on the landscape themselves. Therefore, careful consideration must be undertaken to ensure that hillside homes blend naturally into the surrounding desert environment. Upon completion of construction, the finished grade around the residence and site walls should lie against the walls as near as possible to the original angle of slope.

During the preparation of a preliminary site plan for the homesite, consideration should be given to the impact of the proposed residence and site improvements on neighboring properties regarding privacy, view preservation, natural drainage, and ease of access.

At such time as the preliminary site plan is well enough defined, it is recommended that the corners of the structure(s) be staked on the un-graded site and elevations taken at each corner with a transit. Based upon the findings of this staking, the design should then be adjusted, where necessary, to minimize the buildings height by making it conform more closely to the existing contours.

SITE PLANNING CRITERIA – CUSTOM HOMES ROADWAY STANDARDS

For roadways serving greater than 100 residential units, the design criteria shall be reviewed on a case by case basis with the City of Henderson Public Works Department.

For roadways serving 100 or fewer units, the following standards shall apply:

Right of Way:	42 ft (no parking or parking one side) 45 ft (parking on both sides)
Travel Lanes:	2
Face of Curb Dimension:	24 feet (no on-street parking) 28 feet (parking on one side) 36 feet (parking on both sides)
Curbing	Curbing shall be required. (Curb type shall be as approved by the City Engineer)
Design Speed:	20 miles per hour
Stopping Site Distance:	125 feet
Site Distance (intersections):	200 feet
Minimum Center Line Radius (w/o Superelevation):	180 feet
Minimum Center Line Radius (w/2% Superelevation):	140 feet
Minimum Grade:	0.4%
Maximum Grade:	15%, except that a fire apparatus road within 50 feet of a structure, the grade shall not exceed 8%. In lieu of providing an 8% roadway grade within 50 feet of a structure, the structure shall have a full building fire sprinkler system per City of Henderson Fire Department requirements.
Maximum Grade Length:	7 - 9%: 1400 feet 9 - 12%: 700 feet 12 - 15%: 350 feet
Minimum Curve Length:	100 feet
Vertical Clearance:	13.6 feet
Sidewalks:	Minimum lot sizes less than 20,000 sq. ft.: 4' walk; one-side only Minimum lot sizes greater than 20,000 sq. ft.: No sidewalk required
Cul-de-sacs:	Radius (45 foot measured to the face of curb)
Maximum Units Served:	25.
Vertical Curves	Required if grade difference exceeds 1%.
Roadway Aprons:	2% maximum slope measured 4 feet from the back of curb on both sides of the street.
Right of Way Slope:	3 feet horizontal for 1 foot vertical behind the roadway apron and within the right of way.
Cross Slopes:	4%
Street Lighting:	Intersections and other locations for public safety as required by the City of Henderson Public Works.
Intersection Spacing:	200 feet, measured center line to center line.

While the natural topography of MacDonald Highlands varies considerably from lot to lot, the following general limitations apply, unless special circumstances supporting an exception are approved by the Design Review Committee:

- No change in natural or existing drainage patterns for surface water shall be made on any lot that could adversely affect another lot.
- Retaining walls and other walls not directly supporting a building structure, except screen walls, shall typically not exceed 8 feet in height, measured vertically from the lowest finished grade adjacent to the wall along the exterior side of the enclosure. Where additional height is necessary, and subject to approval by the Design Review Committee, retaining walls must be terraced with a minimum separation of 4 feet between walls and an overall height not to exceed 16 feet. Subject to approval by the Design Review Committee, other acceptable methods for minimizing the impact of retaining walls greater than 8 feet in height include: landscaping with mature indigenous trees or large shrubs; and/or using a different texture and/or material such as stone for a portion of the wall treated to blend with the natural terrain.

- ***Rockery*** retaining walls may not exceed 12-feet in height measured vertically from the lowest finished grade adjacent to the wall along the exterior side of the wall. Where additional height is necessary, and subject to approval by the Design Review Committee, retaining walls must be terraced with a minimum separation of 6-feet between walls [per the City of Henderson *Hillside Development Plan Overlay District Update [ZOA-03-680002]*] and an overall height not to exceed 36-feet. Subject to approval by the Design Review Committee, other acceptable methods for minimizing the impact of retaining walls include: landscaping with mature indigenous trees or large shrubs. Rockery retaining walls must be stained with “Dark Brown” Permeon, coordinated with Soil Tech Industries.
- ***Screen walls***, walls not supporting a building structure or retaining earth, may not exceed 6-feet in height (per City of Henderson requirements) measured from finish grade along the exterior side of the enclosure in the manner described above for retaining walls.
- Stone used as a landscape material shall be 1" or less in size, and shall match the color of the existing native stone on the homesite. Rounded pea gravel may not be used as a landscape or driveway material.
- Native stone indigenous to the site is allowed for rip rap or other landscape treatments, as well as river rock stained to match the native stone.

3.3.7.c Lot Grading and Drainage: Lot grading and drainage should be done with a minimum disruption to the site. Structures, roads, driveways and any other site improvements should be designed to fit the existing contours of the site, minimizing the amount of excavation required rather than altering the site to fit a non-responsive structure or improvement onto the site.

Surface drainage shall not flow to adjacent lots or open spaces except as established by existing natural drainage patterns, or cause a condition that could lead to off-site soil erosion onto such areas.

The design of site improvements should carefully evaluate the potential for erosion based upon the percentage and direction of slope, soil type and vegetation cover. When a change in the natural drainage within a lot is necessary, right angle diversions should be avoided, but rather should create positive drainage in a logical and natural manner. The potential for erosion should be minimized through the use of native rock, plant material, and/or rip rap in disturbed areas. Any changes in a drainage pattern require contour grading and mature landscape to return the drainage way to its natural appearance.

If rip rap or other rock-type erosion control is used for significant drainage ways, it should be naturally contoured and be treated with Permeon. This method still provides the necessary engineered erosion control while creating a more natural looking drainage condition.

In cases where rip rap or other rock-type erosion control methods are used for minor surface drainage, it should be hand placed with flat faces placed up to create a surface plane. Spaces or voids between rocks should be provided to allow for small desert plants and shrubs.

Extensive grading activity on a homesite within MacDonald Highlands is discouraged. Grading is limited to the area within the Building Envelope and the driveway access between the Building Envelope and street. Existing grades must be maintained within the Natural Area of the lot.

Culverts, when used, should be concrete with exposed surfaces and be treated with. In addition, end walls or other terminal structures should be similarly treated as well as a portion of the inside surface of the culvert. The inside should be painted a minimum of two times the opening of the culvert at each end. For example, if an 18" diameter culvert is used, the inside must be painted a minimum of 36" from each end.

Where grading is unavoidable, careful consideration should be given to the impact to the natural appearance of the surrounding landscape. The following measures should be used to minimize negative visual effects of site grading, including:

- Exposed escarpments shall not exceed 2:1 in slope. In order to provide a natural appearance to such escarpments, the slopes should be varied (2:1, 3:1, 4:1 & 5:1) providing an undulating appearance.

- Cut and Fill conditions in excess of 2:1 slope shall use rip rap or other rock-type erosion control methods. Rip rap or other erosion control features shall be stained with Permeon to match the surrounding conditions of the natural desert environment.
- Smooth transitions between escarpments and natural topography are required at the top and toe of such slopes by rounding the transition areas.
- Disturbed areas should be reshaped to duplicate the original natural slope to the extent feasible.
- Disturbed areas should incorporate erosion control measures such as landscaping, rip rap, or other similar techniques, as approved by the Design Review Committee.
- The grading of an individual homesite should respect the existing natural drainage conditions of the lot. Where feasible, existing drainage channels should be maintained in their natural condition.
- In an ongoing effort to promote view corridors for neighboring properties by minimizing the overall building height of residences in the community, if a Lot Owner desires to raise the main finish floor elevation above the curb, then the maximum height permitted by the Design Review Committee is 1'-6" (18") measured from the top of curb elevation at the center of the lot, unless otherwise specified on the city-approved civil improvement plans by the Master Developer.

- For Lots where a dedicated drainage easement exists within the property boundaries (i.e., where approved by the hydrology report), no permanent structures or walls are permitted within the drainage easement and landscape material is restricted to grass and groundcover plants in this area (i.e., large trees are not permitted). In addition, openings such as decorative block or iron will be required to ensure proper drainage flows.

3.3.7.d Retaining Walls: The use of retaining walls may be necessary in certain graded conditions, and the maximum height of the block portion of the retaining wall cannot exceed 8 feet in height.

Where additional height is necessary, retaining walls must be terraced with a minimum separation of 4' between walls to allow for adequate landscaping. The maximum height of the block portion of an individual retaining wall in a terraced condition remains at 8 feet.

Rockery retaining walls may not exceed 12-feet in height measured vertically from the lowest finished grade adjacent to the wall along the exterior side of the wall. Where additional height is necessary, and subject to approval by the Design Review Committee, retaining walls must be terraced with a minimum separation of 6-feet between walls [per the City of Henderson *Hillside Development Plan Overlay District Update [ZOA-03-680002]*] and an overall height not to exceed 36-feet. Subject to approval by the Design Review Committee, other acceptable methods for minimizing the impact of retaining walls include: landscaping with mature indigenous trees or large shrubs. Rockery retaining walls must be stained with "Dark Brown" Permeon, coordinated with Soil Tech Industries.

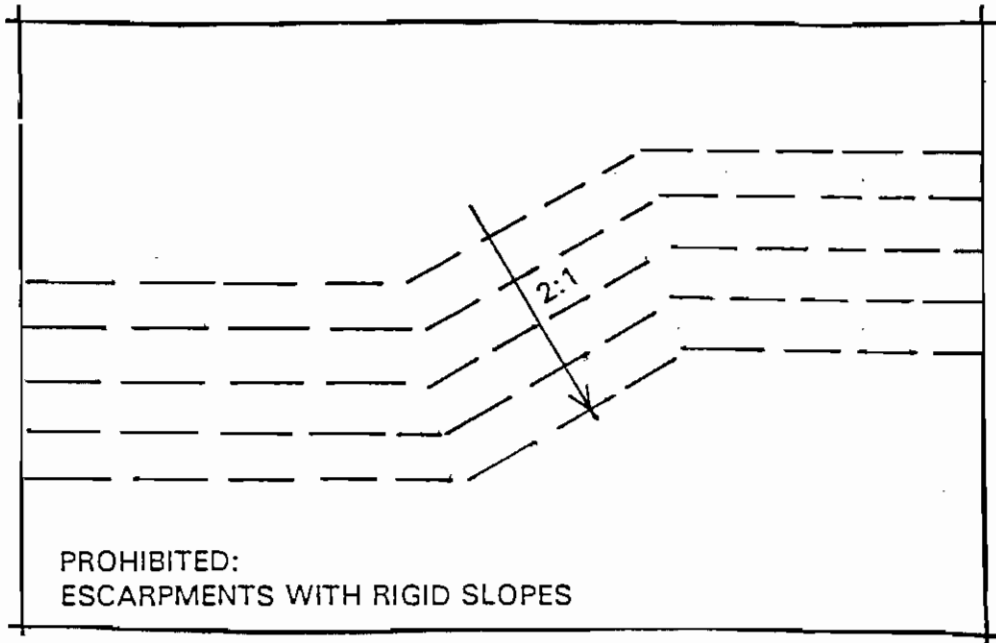
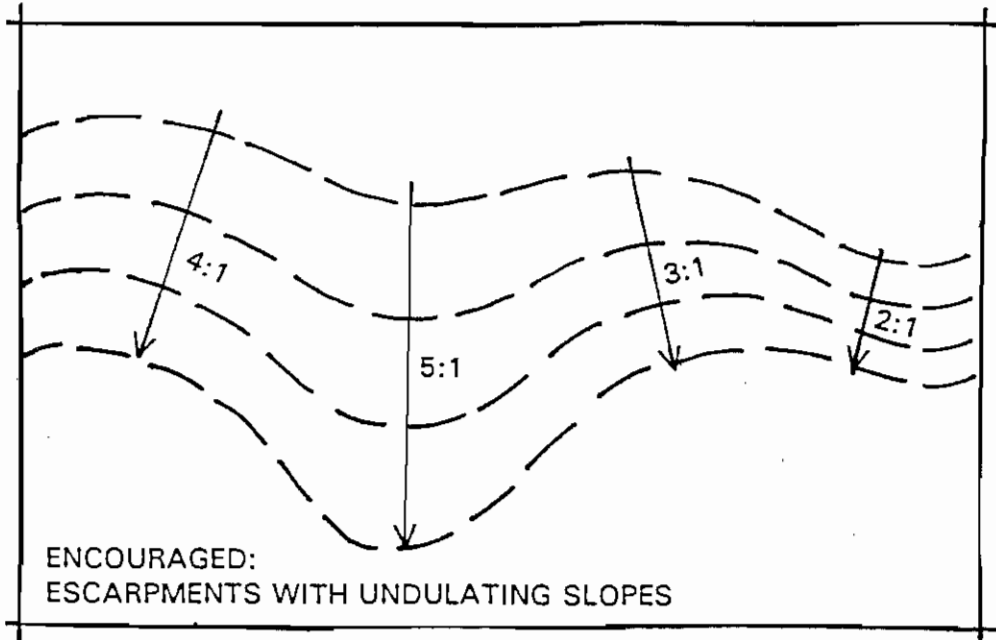

CUSTOM HOMES – ESCARPMENT GRADING

Exhibit “W”

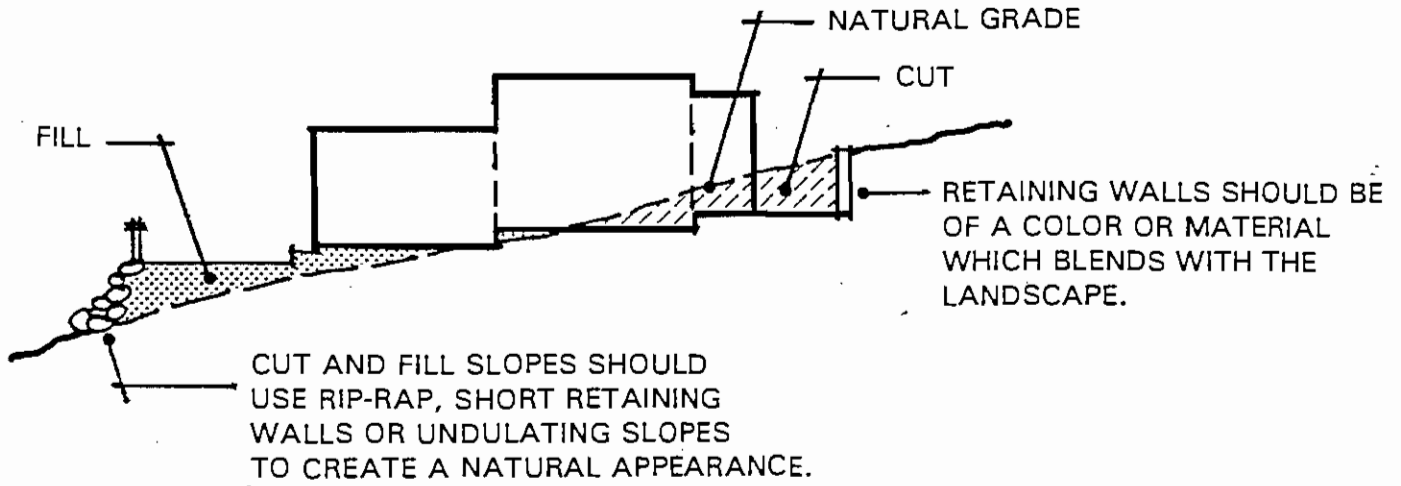
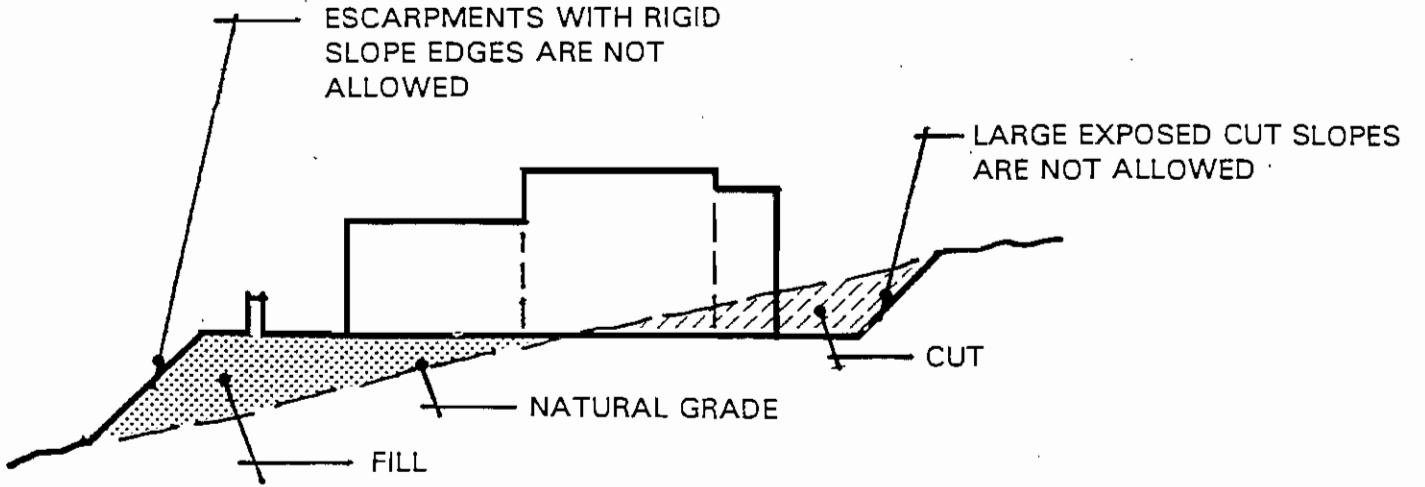

CUSTOM HOMES – GRADING

Exhibit "X"

Open railings up to an additional 3' in height may be allowed on top of a maximum 8'-high retaining wall, subject to approval by the Design Review Committee. The design of such railings must be specifically approved by the Design Review Committee. The maximum height of a retaining wall with iron is 11'-0", however, if the height of the retaining wall is minimized the height of the iron may be increased accordingly, not to exceed a combined height of 11'-0".

Retaining walls should follow the existing contours of the site to ensure a natural blending into the surrounding desert environment.

Retaining walls should have a natural appearance through the use of such materials as stone, brick or slump-stone colored to match the adjacent structure or a color that is compatible with the surrounding desert landscape. Precision-cut concrete blocks or exposed concrete retaining walls will not be permitted.

- 3.3.7.e Driveways:** Driveways in hillside neighborhoods should be kept to one per residence. Additional and circular driveways will be permitted provided they do not adversely disrupt the surrounding environment. The minimum driveway width is 14 feet.

In special cases, a private drive with a maximum length of 600 feet may serve up to four single-family lots. Driveways greater in length than 350 feet or with grades steeper than 15% must receive prior approval from the Fire Department. Driveways in excess of 450 feet in length and driveways, which serve more than a single residence shall meet the requirements for Fire apparatus

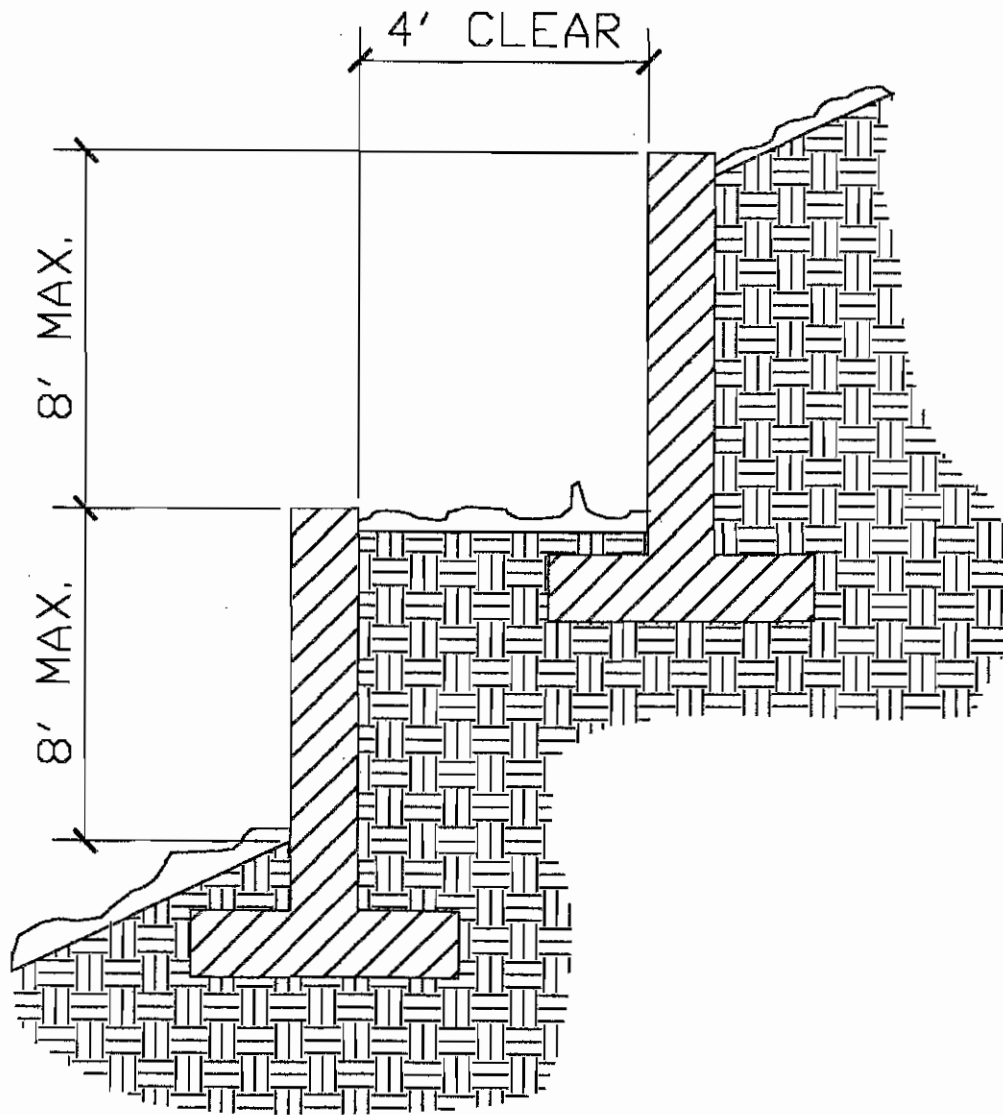

CUSTOM HOMES – RETAINING WALLS

Exhibit "Y"

access roads. An exception to this requirement can be granted if turn-arounds are provided and the driveway meets minimum width requirements. Driveways and parking areas shall be designed for adequate vehicle maneuvering and turn around for a Single Unit Truck (SU) as defined by AASHTO.

On hillside lots, driveways should be designed to follow the natural topography of the site.

Where site conditions warrant, the use of shared driveway access between two lots shall be permitted.

- 3.3.7.f Hillside Architecture:** The sloping topography of a hillside lot, unlike a flat homesite, provides many challenges as well as opportunities. While hillside lots offer dramatic view opportunities, they are also highly visible elements on the landscape themselves. Therefore, careful consideration must be undertaken to ensure that hillside homes blend naturally into the surrounding desert environment.

The terrain in MacDonald Highlands provides a variety of landform and slope conditions throughout the community, requiring different Cut and Fill treatments depending on specific lot conditions, to ensure that the dwelling is well-integrated with the site. The following guidelines address the general Cut and Fill situations. Evaluation of the proposed site improvements will be based on conformance with these Cut and Fill guidelines. The Design Review Committee reserves the right to request that the proposed finish floor elevations be adjusted due to Cut and Fill conditions regardless of compliance with Building Height requirements.

Cut and Fill conditions must meet the intent and goals of these guidelines as well as their technical application. The Design Review Committee may allow exceptions to the technical Cut and Fill guidelines when, in the opinion of the Design Review Committee, the objectives and intent of the Guidelines are still met.

All Cut and Fill excavations must occur within the Building Envelope and any excess fill material must be removed from MacDonald Highlands and disposed in accordance with the requirements of the City of Henderson. Excavated material shall not impact natural areas, nor be disposed over a hillside within MacDonald Highlands.

The building mass of an individual residence should be compatible with the existing natural landforms of the site and surrounding area. This can be effectively accomplished by separating the structure into a series of smaller building forms that conform to the natural topography of the site.

Predominant roof ridgelines should be designed parallel to the natural contours of the site to minimize the visual impact of roofs and gable ends.

Materials and colors should be selected on their ability to blend into the surrounding desert landscape.

SITE PLANNING CRITERIA – CUSTOM HOMES**Hillside Design Criteria – Custom Lot Criteria
Hillside Architecture****Sloping Site - Terraced Floor Levels**

Where the Building Envelope is generally sloped in one direction, and the site improvements are on multiple floors, the following Cut and Fill criteria generally apply:

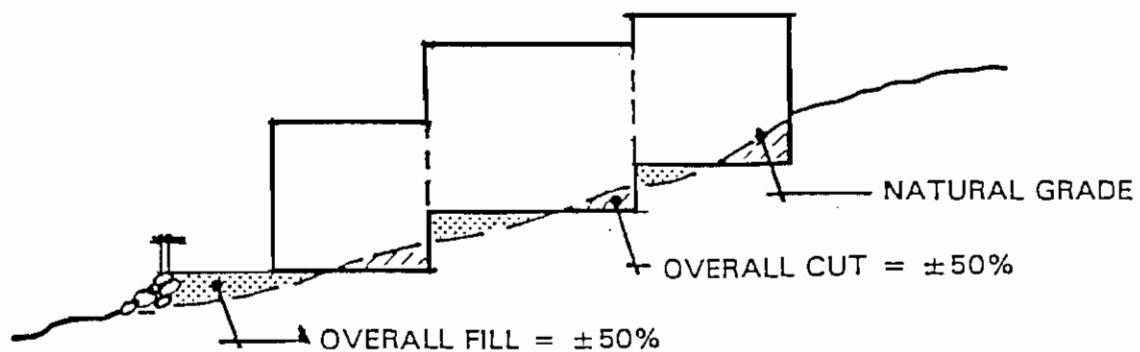

Note: Excess fill material shall not impact natural areas, nor be disposed over a hillside within MacDonald Highlands.

Exhibit "Z"

SITE PLANNING CRITERIA – CUSTOM HOMES**Hillside Design Criteria – Custom Lot Criteria
Hillside Architecture****Sloping Site - Single Floor Level**

Where the Building Envelope is generally sloped in one direction, and the site improvements are primarily on a single floor level, the following Cut and Fill criteria generally apply:

Note: Certain lots are granted exceptions from the above criteria, such that increased fill conditions may be allowed on the lower side of the Building Envelope to take advantage of golf course views. Such exceptions are subject to approval by the Design Review Committee at its sole discretion.

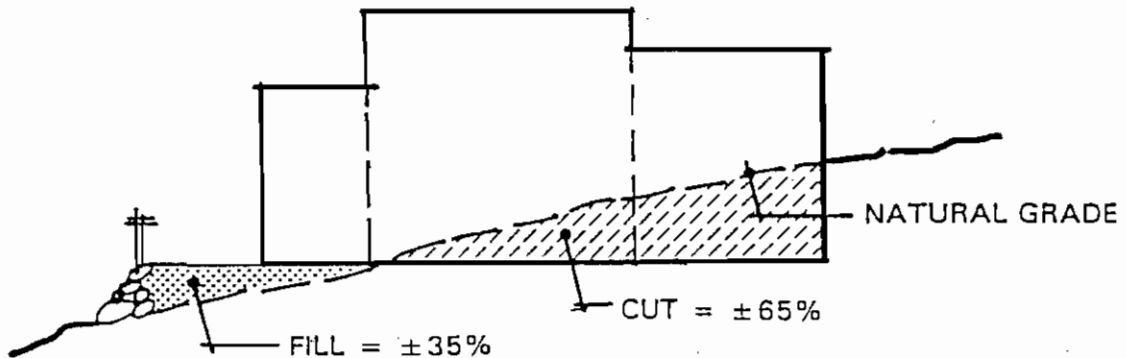
*Notes:*

- *Excess fill material shall not impact natural areas, nor be disposed over a hillside within MacDonald Highlands.*
- *Certain lots are granted exceptions from the above criteria, such that increased fill conditions may be allowed on the lower side of the Building Envelope to take advantage of golf course views. Such exceptions are subject to approval by the Design Review Committee at its discretion.*

Exhibit "aa"

SITE PLANNING CRITERIA – CUSTOM HOMES

Hillside Design Criteria – Custom Lot Criteria
Hillside Architecture

Ridge or Knoll - Terraced Floor Level

Where the Building Envelope is generally located on a ridge, knoll, or other high-point, and the site improvements are on multiple floors, the following Cut and Fill criteria generally apply:

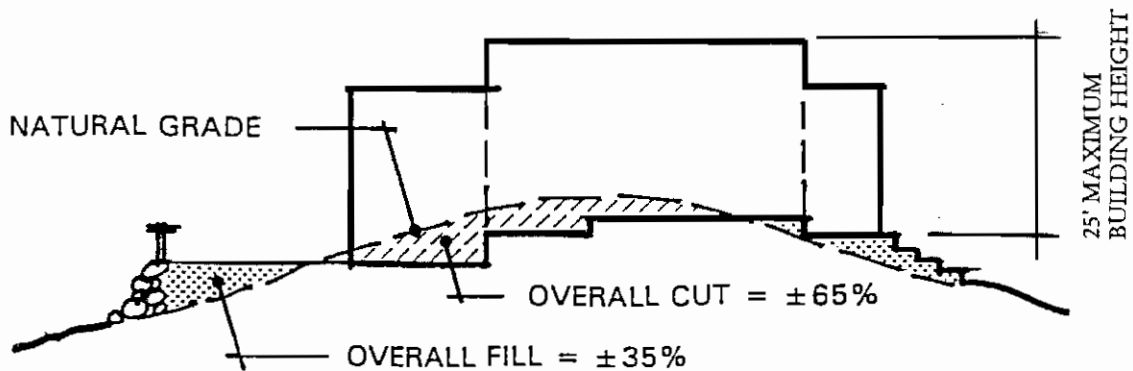

Note: Excess fill material shall not impact natural areas, nor be disposed over a hillside within MacDonald Highlands.

Exhibit "ab"

SITE PLANNING CRITERIA – CUSTOM HOMES

**Hillside Design Criteria – Custom Lot Criteria
Hillside Architecture**

Ridge or Knoll - Single Floor Level

Where the Building Envelope is generally located on a ridge, knoll, or other high-point, and the site improvements are on a single level, the following Cut and Fill criteria generally apply:

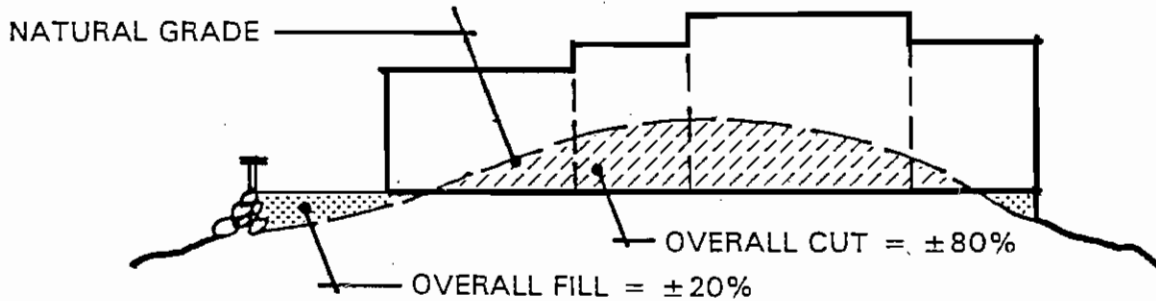

Note: Excess fill material shall not impact natural areas, nor be disposed over a hillside within MacDonald Highlands.

Exhibit “ac”

SITE PLANNING CRITERIA – CUSTOM HOMES

**Hillside Design Criteria – Custom Lot Criteria
Hillside Architecture**

Low Center - Terraced Floor Levels

Where the Building Envelope is generally located in the low area of a lot, a low minor drainage, or other similar depressed areas, and the site improvements are on multiple floors, the following Cut and Fill criteria generally applies:

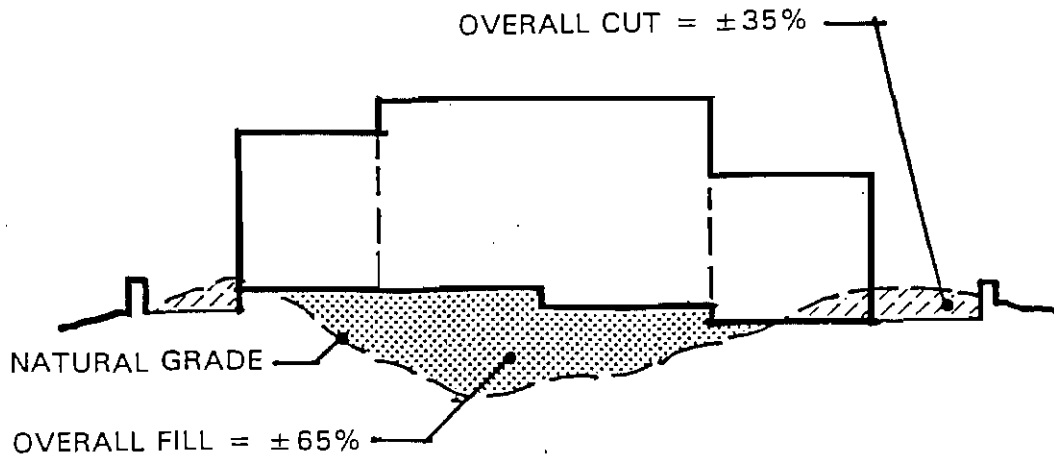

Note: Excess fill material shall not impact natural areas, nor be disposed over a hillside within MacDonald Highlands.

Exhibit “ad”

SITE PLANNING CRITERIA – CUSTOM HOMES

Hillside Design Criteria – Custom Lot Criteria
Hillside Architecture

Low Center - Single Floor Level

Where the Building Envelope is generally located in the low area of a lot, a low minor drainage, or other similar depressed areas, and the site improvements are primarily on a single floor level, the following Cut and Fill criteria generally applies:

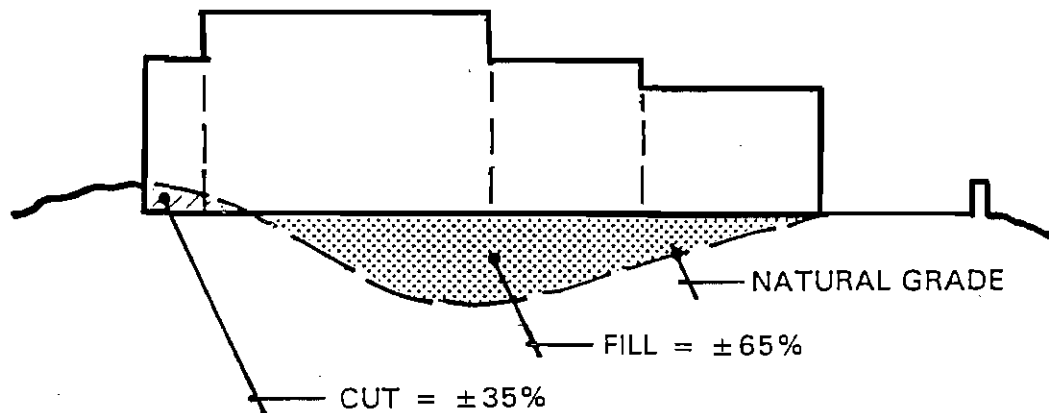
*Notes:*

- *Excess fill material shall not impact natural areas, nor be disposed over a hillside within MacDonald Highlands.*
- *Certain lots are granted exceptions from the above criteria, such that increased fill conditions may be allowed on the lower side of the Building Envelope to take advantage of golf course views. Such exceptions are subject to approval by the Design Review Committee at its discretion.*

Exhibit "ae"

3.3.7.g View Preservation: The hillside character of MacDonald Highlands provides spectacular view opportunities for most of the lots throughout the community. The orientation of the residence's major rooms, patios and terraces should be designed to take advantage of these dramatic views.

While views should be maximized from individual homesites, the residence should be designed and sited such that view opportunities from surrounding lots are not obstructed.

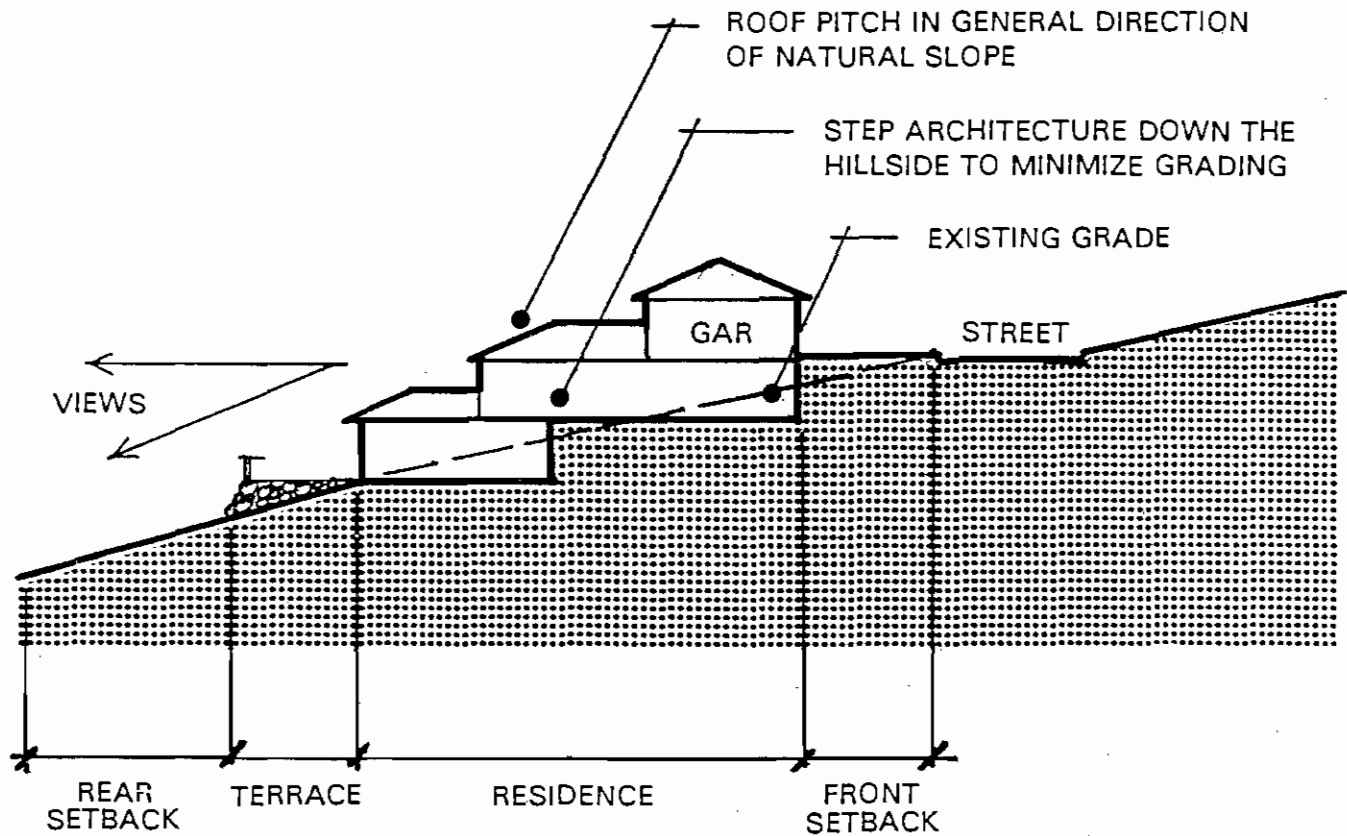

CUSTOM HOMES – VIEW PRESERVATION

Exhibit "af"

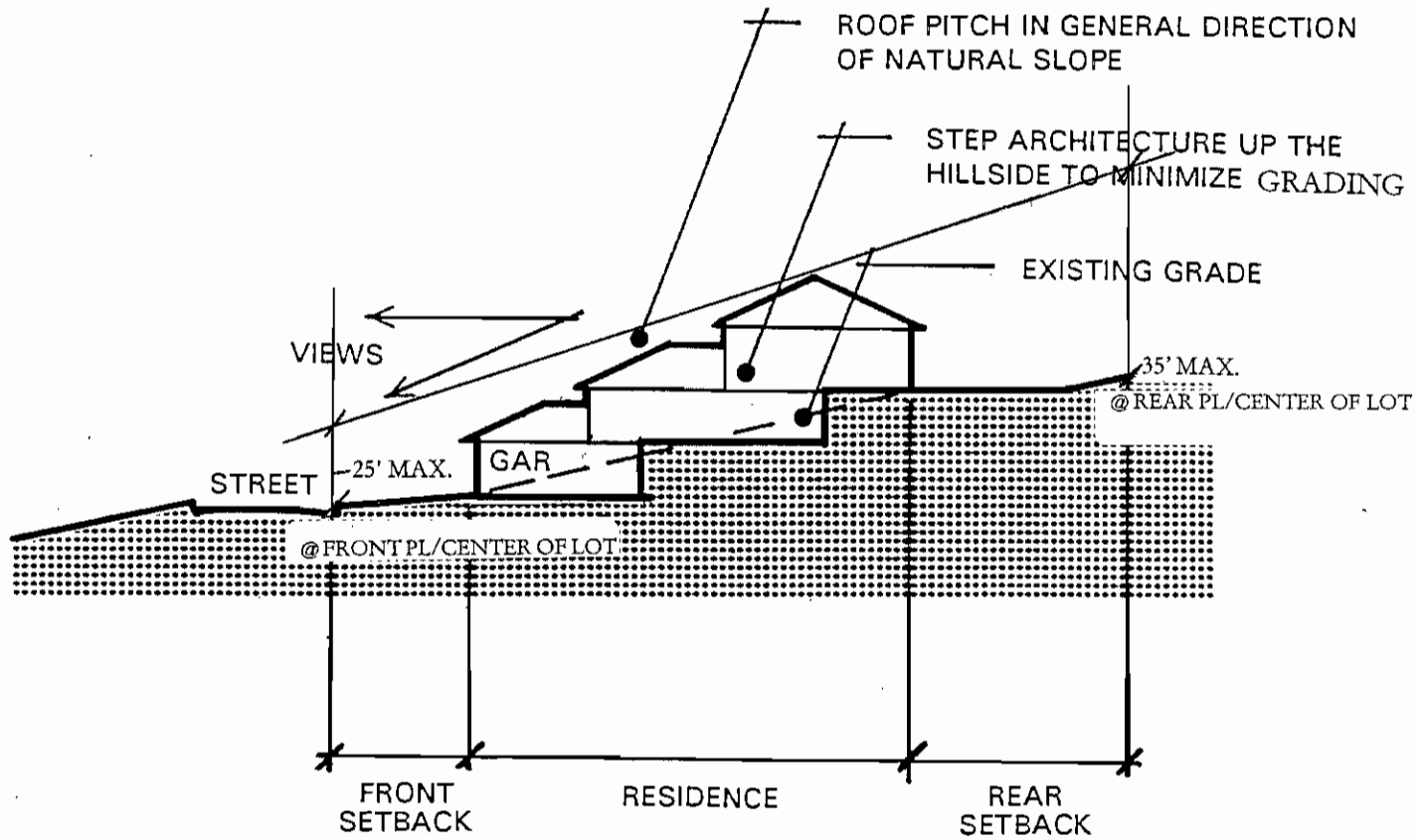

CUSTOM HOMES – VIEW PRESERVATION

Exhibit “ag”

3.4 ARCHITECTURAL DESIGN CRITERIA – CUSTOM HOMES

[Planning Areas 1-Phase I, 3, 4, 5A (Highlands I), 5B, 5C (Highlands II), 6, 7, 8A, 10, 12, 15, 16, 18, 25, 26 (Palisades Unit I) and 27 (Palisades Unit II)]

3.4.1 ARCHITECTURAL CHARACTER

The primary goal for the design of residences within MacDonald Highlands is to create a homesite that integrates the architecture of the dwelling with the natural character of the surrounding desert landscape. The resulting architectural style is best described as "Desert Elegance", exemplified by strong horizontal building forms with a minimum of ornamentation. This integration of architecture to the site is further enhanced through the extensive use of terraces and courtyards providing a strong indoor/outdoor relationship to the residence. Finally, the proper use of color is crucial for the successful design of the house. Building colors have been selected for their ability to blend naturally into the desert environment, such as "earthy" tones of buff, sand, beige, gray and other hues of the areas natural landscape. Bold color schemes featuring crisp whites, pastels, or bright colors are not permitted.

The purpose of the Architectural Design Criteria is to ensure that the architectural character of the Custom Homes is compatible with that of the overall character envisioned for MacDonald Highlands, while encouraging unique, innovative and creative design solutions to individual residences. Individual consideration will be given to the aesthetic and physical relationships of the residence to the site and adjacent dwellings.

3.4.2 FLOOR AREAS

Architectural Character – Custom Lot Criteria
Floor Areas

	PLANNING AREA	LOT SIZE	RESIDENCE SQ. FT. RANGE
Compound Estate	13	1-3 Acres	10,000+
Manor Estate	5B and 12	1 Acre	5,500 - 25,000
Manor Estate	10	1/2 to 1 Acre	5,500 - 25,000
Hillside Estate	6, 7, 18, 26, Palisades Units I and II	1/2 Acre	3,500 - 13,500
Golf Estate	1-Phase 1, 8A, 15/16	1/2 Acre	3,500 - 15,000
Executive Estates	3, 5A, 5C (Highlands Units I and II)	1/3 Acre	3,000 - 5,000

NOTE: The square footage of any subsurface level, which has at least one side exposed will be considered part of the total allowable square footage of a Residence. However, the square footage of any subsurface level that has no exposures to the surface (i.e., a “Cellar”) will not be considered part of the total allowable square footage.

NOTE: Executive Estate Lots requiring electrical panels in excess of 400-amps require prior Nevada Power Company written approval to ensure electrical needs for the residence are attainable. Said approval shall be included as part of the schematic plan submittal package.

3.4.3 Architectural Components

BUILDING FACADES	ROOFS	ARCHITECTURAL FEATURES / ACCENTS
FORM / MASS COURTS / PORCHES SHADOW OPENINGS MATERIALS / TEXTURE	ROOF PITCH OVERHANGS MATERIALS	ACCENT WINDOWS / DOORS DECKS / PATIOS FENCES / WALLS ACCENT COLOR / TREATMENTS

The architecture of a custom home can be broken down into three major components, including 1) Building Facades, 2) Roofs, and 3) Architectural Features & Accents. The proper design treatment of these three components will result in a visually pleasing residence and neighborhood environment throughout MacDonald Highlands. The following is a general description of how each of these components should be addressed relating to the Desert Elegance architectural style.

3.4.4 Building Facades

The three dimensional success of a building and its site elements is a result of the careful treatment of building mass, proportion and scale, articulated by a variation in texture, materials, and color treatment. In general, large building masses should be avoided because of the resulting scale that would be out of balance in achieving a desirable relationship to the desert environment. Structures that require greater amounts of space, should have vertical and horizontal offsets to break up the building mass and create a more desirable scale and visual interest to the dwelling. The interplay of shade and shadow, along with texture and openings in large building surfaces provides interest, balance, and

human scale to the residence. In addition, the use of terraces, porches and balconies, window and entry treatments further emphasize building articulation. Together, each of these elements enable the creation of a residence, which will blend harmoniously into the natural desert environment.

3.4.4.a Building Massing and Scale: the Desert Elegance style of residential architecture features a strong horizontal character achieved through the predominant use of one-story residences.

No single-story restricted Structure shall exceed 20 feet measured as the vertical distance in feet between *curb* finished grade *at the center of the lot* to the highest roof peak. In certain cases, if a 2-story element is approved by the Design Review Committee, it will be subject to additional criteria outlined within these Design Guidelines.

An exception is pre-graded lots, which, by design, prevent this.

Those Residences that obtain an approved 2-story element may not exceed a height of 35 feet measured as the vertical distance in feet between *curb* finished grade *at the center of the lot* to the highest roof.

The MacDonald Highlands Design Review Committee is responsible to enforce the measurement requirement of all structure heights within the community.

3.4.4.b Building Height: Specific guidelines have been established based upon the overall topographical character of the lot, including relatively flat lots with slopes less than 5%, and hillside lots with slopes exceeding 5%.

3.4.4.c Hillside Lots With Slopes Exceeding 5%: On hillside lots, residential design should carefully consider the existing site conditions, and should be designed as an integral element of the landscape. Multi-level designs which "step-down the hillside" and relate strongly to the topography of the site are encouraged.

3.4.4.d Sloping Height Limit: For lots with a naturally occurring slope *in excess of 5%*, a sloping building height limit shall apply. This sloping building height is formed by the intersection of two lines as described below:

- A horizontal line measured 20' for single-story residences or 25' for two- or more-story structures directly above curb elevation at the front property line in the center of the lot intersected with a line measured 35' directly above and parallel to the existing grade along the rear property line at the center of the lot. Please refer to Exhibit "ah". Due to the unique and varied topography, the Design Review Committee may approve, on a case by case basis and at its sole discretion, increases in the sloping height limitations.

- This sloping height limit ensures that the single-story character of residences is maintained along neighborhood streets, while allowing multi-level designs to terrace down the hillside at the rear to minimize grading requirements, and to take advantage of view opportunities.
- The Design Review Committee may from time to time consider requests for adjustments to the Maximum Building Height Elevations. The criteria for such variances will be the quality of building materials and overall design, logic and common sense. All such variances will be made at the sole discretion of the Design Review Committee and must ultimately be approved by the City of Henderson Building and Planning Departments.
- The MacDonald Highlands Design Review Committee is responsible to enforce the measurement requirement of all structure heights within the community.

3.4.4.e Reversed Sloping Height Limit: For uphill lots assigned a “reversed sloping height limit” classification, the sloping building height is formed by the intersection of two lines as described below:

- A horizontal line measured 35’ directly above curb elevation at the front property line in the center of the lot intersected with a line measured 20’ directly above and parallel to the existing grade along the rear property line at the center of the lot. Please refer to Exhibit “ai”. Due to the unique and varied topography, the Design Review Committee may approve, on a case by case basis and at its sole discretion, increases in the sloping height limitations.

- This sloping height limit ensures that the single-story character of residences is maintained along neighborhood streets, while allowing multi-level designs to terrace up the hillside at the rear to minimize grading requirements, and to take advantage of view opportunities.
- The Design Review Committee may from time to time consider requests for adjustments to the Maximum Building Height Elevations. The criteria for such variances will be the quality of building materials and overall design, logic and common sense. All such variances will be made at the sole discretion of the Design Review Committee and must ultimately be approved by the City of Henderson Building and Planning Departments.

The MacDonald Highlands Design Review Committee is responsible to enforce the measurement requirement of all structure heights within the community.

- 3.4.4.f Lots With Slopes Less Than 5%: Single-story residences which step-down the hillside are less practical on lots *with a slope of less than 5%*.

No single-story **restricted** structure shall exceed 20 feet, while the maximum building height for a two-story structure is 35'. Both dimensions are measured as the vertical distance in feet between **curb** finished grade *at the center of the lot* to the highest roof peak. Limited architectural projections, i.e., chimneys and roof vents, can be extended beyond this height subject to the approval of the Design Review Committee.

3.4.4.g Massing: The proper massing of Desert Elegance architecture will reduce the visual scale of a large structure, and create building texture, which helps blend the residence with the surrounding natural environment.

Unless otherwise specifically approved by the Design Review Committee, homes less than 5,000 square feet shall be composed of at least three visual building masses as viewed from any elevation, while homes larger than 5,000 square feet, excluding garages, shall feature at least four visual masses as viewed from any elevation.

3.4.4.h Articulation: All height limitation criteria form the basis of general massing only. For example, in addition to the overall massing which must step with the terrain, it is expected that all elevations will not only take advantage of the view from within the residence, but will also provide pleasant views from all surrounding areas, as well. All side and rear elevations should be articulated to break up the facade into smaller elements, as well as adding the richness of shade and shadow. Large blank walls will not be allowed. Failure to provide adequate articulation and richness may be grounds for rejection of the design by the Design Review Committee.

The horizontal character of Desert Elegance architecture is enhanced by the integral design of outdoor living spaces such as terraces and patios as a transition between the residence and the natural landscape environment. Extended roof forms and broad overhangs are often used to provide cover for these spaces, protecting them from the harsh climatic conditions of the desert.

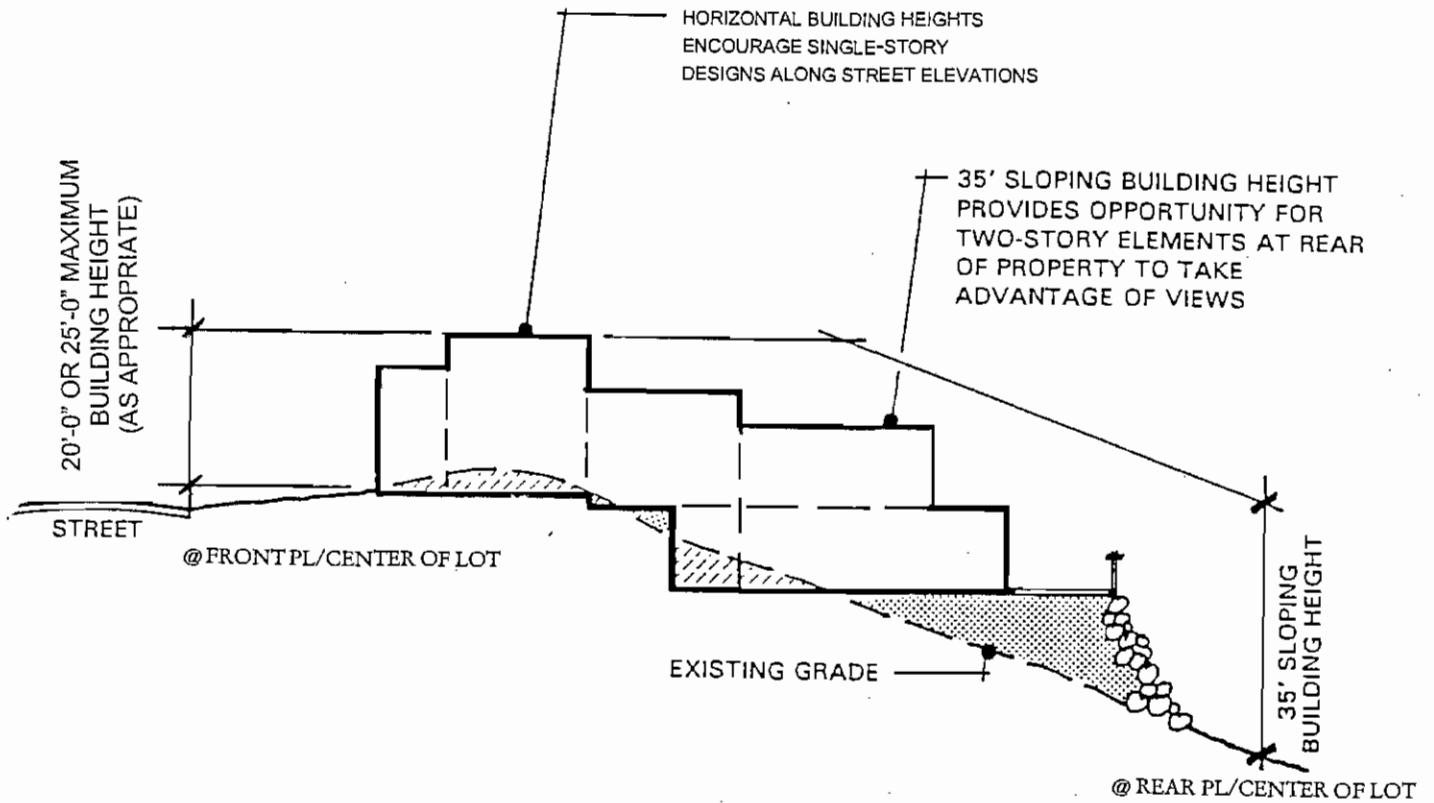

DRC CLARIFICATION NOTE:

20'-0" for single-story structures

25'-0" for two-story structures

MacDonald Highlands Reverse sloping height limit

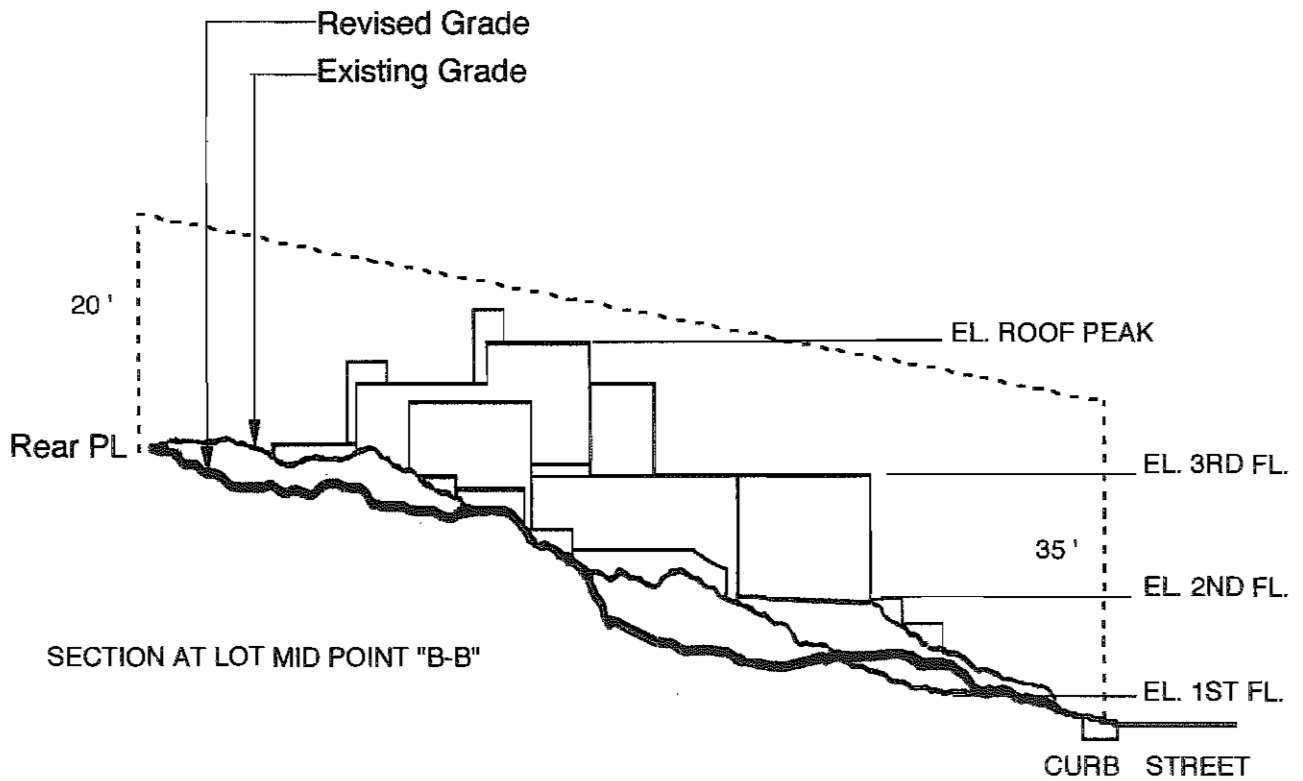
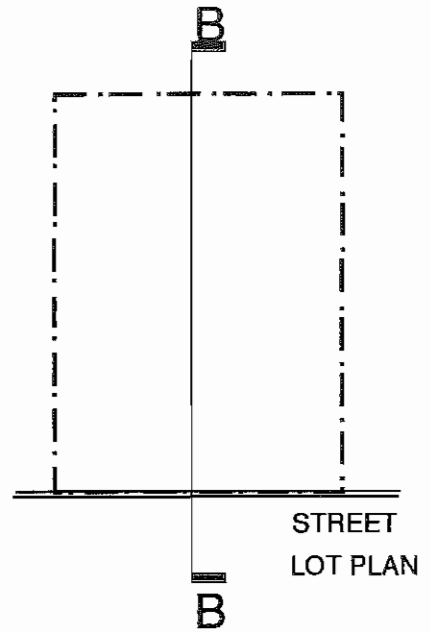

CUSTOM HOMES – REVERSED SLOPE HEIGHT CRITERIA

Exhibit "ai"

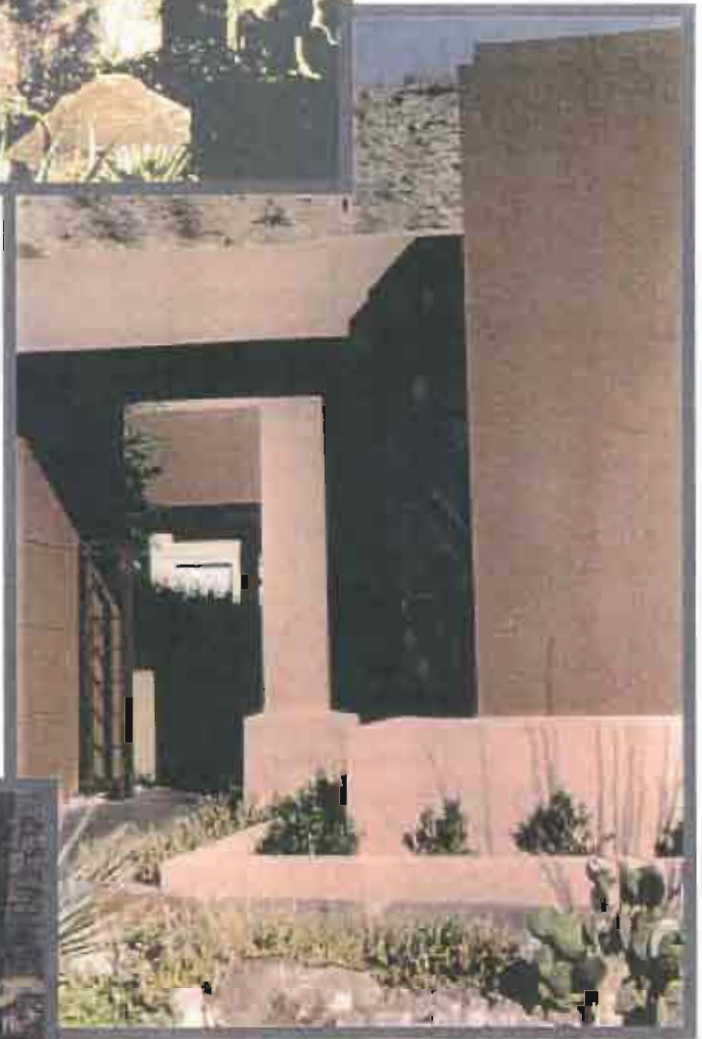

MACDONALD
HIGHWAYS

The use of front entry courtyards is encouraged as a transition from the public space of the street to the private dwelling. Building wings as well as landscape walls (or a combination of these) are effective in creating this entry courtyard space.

The horizontal character of Desert Elegance architecture is further enhanced by the use of articulated roof forms combining low pitched hip roofs and flat roof forms. The zoned activity areas are often highlighted by the use of pyramidal roof forms.

- 3.4.4.i Exposed Wall Heights:** In no case shall a wall have an unbroken height of more than 25 feet measured vertically from the finished grade at its lowest point along the wall to the top of the wall. Door and window penetrations and applied banding or textured relief in a wall plane do not change the measurements of an unbroken wall height.



Exhibit "ak"
Page 3.72

3.4.5 Exterior Materials

Exterior surfaces shall generally be of natural material that blend with and are compatible with the natural landscape. Materials should be selected based on their ability to withstand the extreme climatic conditions of the desert. Exterior building walls shall consist of at least one, but not more than three of the following:

- Stone such as the following:
 - Granite (Thermal or Honed Finish)
 - Arizona Sandstone (Thermal or Honed Finish)
 - Slate (Cleft Finish)
- Split-face CMU block of earth tone colors compatible with the surrounding desert environment
- Brick (clay)
- Stucco or plaster with a light to medium texture, such as dash, smooth, sand or lace. (Heavy textures such as swirl or heavy trowel are prohibited.)
- Glass / Glass Block

Large expanses of painted surfaces, particularly wood, will not weather well in desert conditions and will not be approved.

All residences shall feature "wrap-around" architecture, which is all four sides of the building shall have a consistent level of detail in terms of materials and architectural detailing. The purpose of this requirement is to ensure that all elevations of a Residence will be considered equally during the evaluation and review process, particularly for those residences with frontage on the golf course or other public spaces. If the use of stone is eliminated on one or more of the exterior elevations, it must be removed from the remaining elevations as well.

All surface treatments or materials shall be designed to appear as an integral part of the design, and not merely applied. All materials shall wrap columns, porches, or balconies in their entirety. Material wainscoting (i.e., the application of stone along the lower portion of an elevation) and random patterns are not preferred—applying masonry material in massed elements is more appropriate to the Desert Elegance architectural theme of the community. If a masonry material is used in a massed element on the front of a residence then the remaining three sides of the residence shall also have a stone-massed wall plane. The application of a masonry material that is only visible from the ground level within the yard is no longer permitted.

Material changes (where proposed) should occur at inside corners. Siding materials shall be continuous to within 6" of finished grade. Exposed footings are not permitted.

Highly reflective finishes shall not be used on any exterior surfaces.

3.4.6 Color Overview

Nestled in the McCullough Mountain range, east of Las Vegas, the community of MacDonald Highlands has a unique natural setting. Building colors and materials must be in muted desert shades in order to blend the residences harmoniously into the surrounding desert landscape. To help builders and architects achieve this goal, MacDonald Highlands has developed a color program that:

- Identifies appropriate colors.
- Outlines criteria for color selection.
- Gives guidelines for color implementation.

All builders and architects shall utilize this color program in the planning and execution of exterior finishes.

3.4.7 Color Program

Roof, field and masonry color palettes have been identified for use at MacDonald Highlands. Builders are required to make their selections from these palettes, however, additional colors and color combinations may be considered by the Design Review Committee provided the alternate color(s) complies with community-specified light reflectance value ranges, and is consistent with and compliments the natural surroundings. Final approval or disapproval of an alternate paint color(s) and/or color combination(s) will be judged at the sole discretion of the Design Review Committee.

The community-approved palettes are defined by the following criteria:

- Roof colors that are flashed or modeled and have a medium light reflectance value (LRV).
- Field colors that are muted shades with a light reflectance value (LRV) between 60% and 15%.
- Masonry materials that are natural in form and compatible in color with the desert environment.

The topography of the development suggests the need for two levels of field color usage. The Lower Hillside areas have full use of all colors in the defined Field Color Palette where the more visually sensitive Upper Hillside areas have a qualified use of the palette. Exhibit “al” identifies the site locations of these two field color categories.

The Lower Hillside areas have a field color palette that is defined by colors with a LRV between 60% and 15%. This is available for secondary as well as primary field colors. The Upper Hillside

areas may only use the colors in the Field Color Palette with a LRV between 55% and 25% for the primary field colors. However, secondary field colors in the Upper Hillside areas may be selected from any color in the Field Color Palette. Exhibit “am” provides a full listing of all approved roof, field and masonry (faux) materials.

Remaining colors to be identified for a residential color scheme, fascia, trim, garage door & accent must also be in muted shades that blend appropriately with the desert environment. These colors may be selected by the builder or architect, from their own source, as long as they maintain a LRV of 70% or less and will be reviewed by the Design Review Committee.

3.4.8 Color Palette Design Kit

A “Color Palette Design Kit” (Design Kit) has been created for use by the builders and architects in MacDonald Highlands to assist them with their selections from the defined roof, field and masonry palettes. Each Kit contains a color fan deck of the Field Color Palette as well as a listing of the approved roof and masonry colors. Within the Field Color Palette, the Upper Hillside primary field color options will be identified by shortened paint chips. Listed on the front of each chip in the fan deck is the manufacturer’s reference number, name and light reflectance value (LRV).

FRAZEE PAINT was selected for use in the Design Kit, *however, manufacturer crossovers are acceptable so long as the corresponding Frazee number, name and LRV are noted when submitting a color package or scheme to the Design Review Committee for review.*

3.4.9 Builder Color Requirements

Builder color palettes shall utilize the following guidelines:

3.4.9.a Color Scheme Number:

- Custom Homes shall have six color schemes minimum.
- Attached Housing shall have three color schemes minimum.

3.4.9.b Roof Colors: Roof colors shall be selected from the defined palette. *Manufacturer crossovers are acceptable only if they maintain the roof color criteria.*

- Custom Homes shall have three or four roof colors or blends as part of the project color package.
- Attached Housing projects shall have one roof color or blend.

3.4.9.c Building Colors: Each color scheme shall have a minimum of three different colors not counting the roof or any masonry material. All field colors shall be different with a discernable difference between them. Schemes utilizing a primary and secondary field color shall have a 15% LRV spread between them. Only one third of the color schemes may use the same fascia color. Only one third of the color schemes may use the same trim color. All accent colors are to be different.

If a masonry material is used in a massed element on the front of a residence then the remaining three elevations shall also have a stone-massed wall plane. The application of a masonry material that is only visible from the ground level within the yard is no longer permitted.

3.4.9.d Masonry: Custom Homes shall have a masonry material integral to one third (minimum) of their building elevations.

3.4.9.e Color Plotting: In an effort to offer the most balanced blend of materials and colors as possible, adjacent and facing residences shall not have the same front or rear elevation and shall not have the same color scheme. However, opposite hand footprints with variations in elevation design elements and a different color scheme will be permitted.

3.4.10 Custom Color Requirements

Custom home color palettes shall utilize the following guidelines:

3.4.10.a Roof Colors: Roof colors shall be selected from the approved palette. *Manufacturer crossovers are acceptable only if they maintain the roof color criteria.*

3.4.10.b Building Colors: The field color(s) shall be selected from the Field Color Palette. See Exhibit "al" for which color area, Upper or Lower Hillside, your lot is located within. A customhouse color palette shall have a minimum of three different colors not counting the roof ~~or hardscape colors and/or materials.~~

One of those colors may be substituted with a masonry material, however, if a masonry material is substituted for one of the three required colors, it must be used consistently and effectively on all four sides of a residence. If a masonry material is used in a massed element on the front of a residence then the remaining three elevations shall also have a stone-massed wall plane. The application of a masonry material that is only visible from the ground level within the yard is no longer permitted.

Hardscape colors and/or materials do not classify as one of the three required colors, as these accents are not applied to the actual residence.

3.4.11 Color Submittals

Submittals for Builder color packages and Custom Home color palettes to the Design Review Committee must contain the following information:

A color and material sample board showing the selected building colors, roof and masonry material. *The Frazee paint reference number, name and LRV must be identified on the board. **Paint crossovers must list the Frazee color as well.***

When multiple field colors are used, exterior elevations showing the color application strategy shall be submitted (i.e., Color Blocking Exhibits). See Exhibit “an” for submittal example.

Manufacturer cut-sheets, photographs or samples of all exterior materials, colors and textures *are required* at schematic plan submittal. Examples include windows, glass block, skylights, roof top windows, Solatubes®, solar panels, flat roof surface material, railings, wrought iron gates, doors (typical), front doors, patio doors, garage doors, landscape lighting, wall-mounted light fixtures, recessed lighting; driveway, walkway, terrace, balcony and patio materials; address identification device, etc.

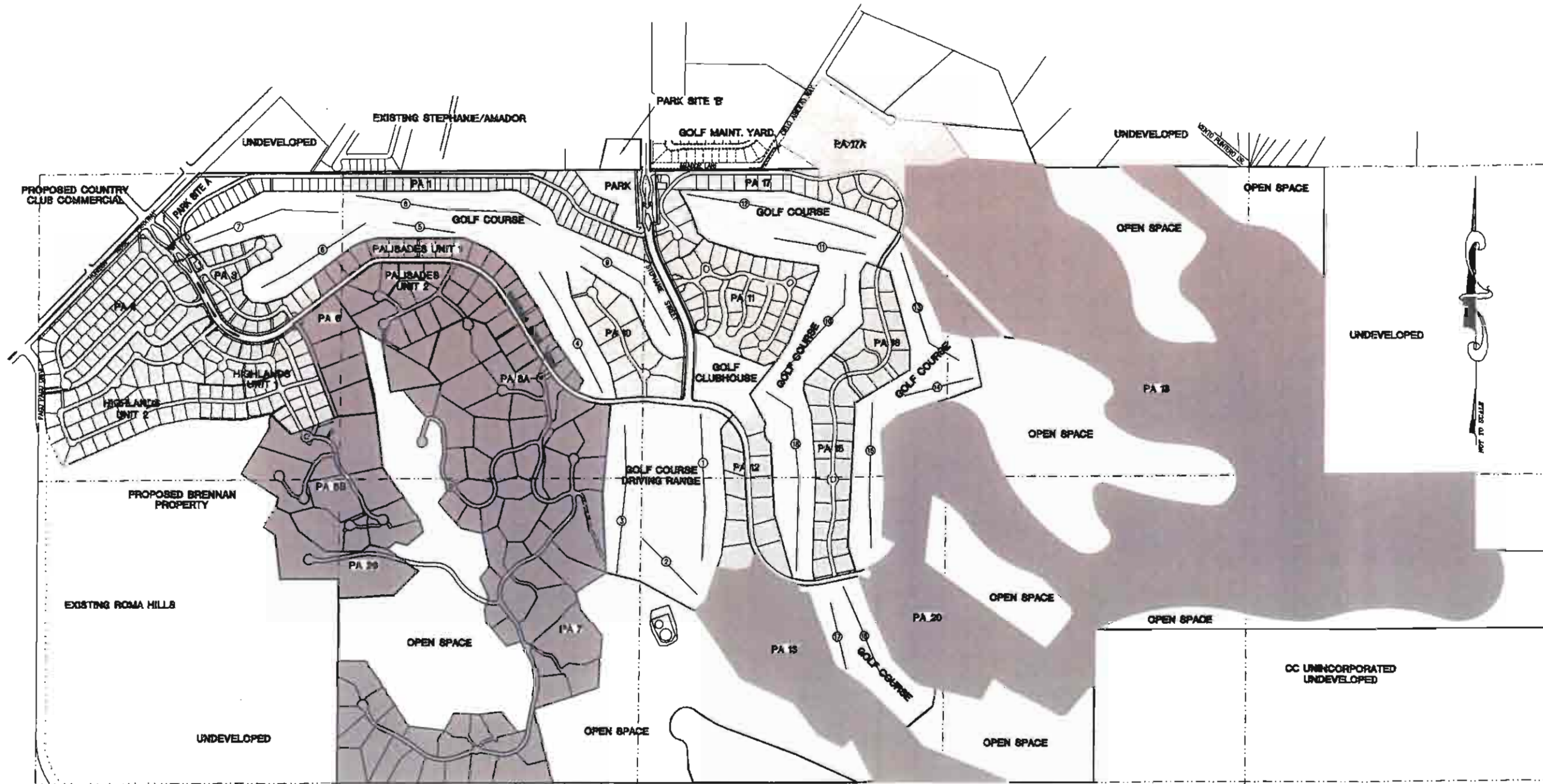

SECTION 33
UNDEVELOPED

SECTION 33
SECONDARY ACCESS

CC UNINCORPORATED
UNDEVELOPED

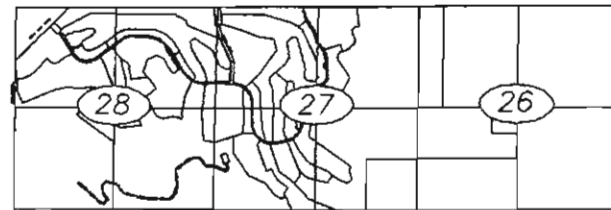

PROJECT LOCATION
SECTIONS 26, 27, AND 28
TOWNSHIP 22 SOUTH, RANGE 62 EAST,
HENDERSON, CLARK COUNTY, NEVADA

LOWER HILLSIDE

UPPER HILLSIDE



MACDONALD
HIGHLANDS

BY: FOOTHILLS DEVELOPMENT CO.
1700 HORIZON RIDGE PARKWAY, SUITE 200
HENDERSON, NEVADA 89012

UPDATED NOVEMBER 2002

REVISION	DATE	BY

TITLE	LOWER/UPPER HILLSIDE LOTS
PROJECT	MACDONALD HIGHLANDS

--

<p>VF DESIGNING FOR THE FUTURE PLANNERS • CONSULTING ENGINEERS • ARCHITECTS 3835 WEST SUMMIT AVENUE • LAS VEGAS, NEVADA 89103 • (702) 246-4444</p>	W.O. # : 320-CR20
	BY : RRM
	DATE : 11/02
1 of 1 SHEETS	SCALE : NONE

ARCHITECTURAL COLOR PALETTE

FIELD COLORS

Lower Hillside – Field Color Palette

8253M	8254M	8255D	
8283W	8284D	8285A	
8303W	8304M	8305D	
8664M	8665D		
8683W	8684M	8685D	
8693M	8694M	8695D	
8703M	8704D	8705D	
8713W	8714M	8715D	
8723M	8724M	8725A	
8732W	8733M	8734M	8735D
8742W	8743M	8744D	8745A
8753M	8754D	8755A	
8773M	8774M		
8812W	8813W	8814M	
8822W	8823W	8824M	

Upper Hillside – Primary Field Color Palette

8253M	8254M	
8283W	8284D	
8303W	8304M	
8683W	8684M	
8693M	8694M	
8713W	8714M	
8723M	8724M	
8732W	8733M	8734M
8742W	8743M	8744D
8752W	8753M	8754D
8762W	8763M	
8773M		
8812W	8813W	
8822W	8823W	

Exhibit “am”

ROOF COLORS

MONIERLIFETILE:

Standard Shake:	1SRCB3233R	Brown Blend Brushed (formerly #501)
	1SRCB1430R	Charcoal Blend Brushed (formerly #503)
	1SRCB1132R	Charcoal Brown Blend Brushed (formerly #505)
Standard Slate:	1LSCS3233R	Brown Blend (formerly #1271)
	1LSCS1430R	Charcoal Blend Brushed (formerly #1273)
	1LSCS1132R	Charcoal Brown Blend Brushed (formerly #1275)
	1LSCS4598R	Forest Green (formerly #1248)
	1LSCS0026R	Sandstorm (formerly #1280)
M2000Shake / Vignette:	1SKCB3960	Cattails
	1SKCB3940	Cliffside
	1SKCB3934	Saddle
	1SKCB5937	Silver Rock
	1SKCB5932	Silver Smoke
	1SKCB3958	Smokey
/ Collage:	1SKCB3949	Mahogany
	1SKCB7951	Mulberry
	1SKCB3942	Raffia
M2000Slate/ Vignette:	1STCS3960	Cattails
	1STCS3940	Cliffside
	1STCS7933	Flashburn
	1STCS6938	New Bronze
	1STCS3934	Saddle
	1STCS4930	Silhouette
	1STCS5937	Silver Rock
	1STCS7980	Slate Plum
	1STCS3958	Smokey
	1STCS0959	Turtle Dove
/ Collage:	1STCS7954	Camelot
	1STCS3957	Cobblestone
	1STCS3947	Heather
	1STCS3949	Mahogany
	1STCS7951	Mulberry
	1STCS3942	Raffia
/ Tapestry:	1STCS5969	Wolf Grey
	1STCS3963	Camouflage
	1STCS4976	Impressionist
	1STCS3962	Tiger Eye

Exhibit "am"
(continued)

MONIERLIFETILE (continued)

M2000Split Shake		
/ Vignette:	1SECB3934	Saddle
/ Collage:	1SECB3949	Mahogany
	1SECB3946	New Bark
/ Tapestry:	1SEBC3963	Camouflage
T2000 – Traditions:	1TRCD3083	Hearthside
	1TRCD3079	Manorhouse
	1TRCD3085	Plantation
	1TRCD3080	Riverpebble

PIONEER

Standard Slate:	SL 550	Ironwood Blend
	SL 547	Sandalwood Blend
	SL 544	Cocoamo Grey
	SL 543	Camino Blend
	SL 541	Santa Clara Blend
	SL 540	Solano Blend
	SL 513	La Jolla Blend
	SL 433	Kona Blend
	SL 503	Cobblestone Green
	SL 471	Birchwood Blend
	SL 504	Boroughwood
Weathered Shake:	WS 550	Weathered Ironwood Blend
	WS 544	Weathered Cocoamo Grey
	WS 543	Weathered Camino Blend
	WS 541	Weathered Santa Clara Blend
	WS 540	Weathered Solano Blend
	WS 513	Weathered La Jolla Blend
	WS 411	Chestnut Brown
	WS 471	Birchwood Blend
	WS 546	Oakwood Blend
	WS 504	Boroughwood

DISCONTINUED MONIERLIFETILE

(Discontinued by MonierLifetile January 2000)

General Line:	1276	3188	3206		
Vignette:	7973				
Collage:	3935	3961	7943	7952	7977
Tapestry:	7971				

Exhibit "am"
(continued)

MASONRY COLORSEldorado Stone:

Hillstone: Molano, Lucero

Fieldledge: Meseta, Veneto

Shadow Rock: Teton, Bronze, Mountain Blend

Rustic Ledge: Sequoia, Prairie, Sawtooth, Cascade (w/wo rubble)

Mountain Ledge: Smokey, China, Buckskin, Warm Springs, Copper

Stacked Stone: Mountain Blend, Desert Shadows, Slate Gray, Castaway

Weather Edge: Wisconsin, Calistoga

Cultured Stone:

Country Ledge: Honey, Chardonnay, Caramel, Aspen

Southern Ledge: Chardonnay, Rustic, Fog, Bucks County

Weather Edge Ledge: Fox Valley, Wisconsin, Silverado

Pro-Fit Ledge: Mojave, Autumn, Shale

Caroline Ledge: Vintage Sand, Pewter Gray, Onyx Brown,

Silver Sand

Drystack Ledge: Caramel, Chardonnay, Mist, Cedar, Suede

Southern Ledge & Dressed Fieldstone: Fog & Aspen, Bucks County,

Rustic & Brandywine, Chardonnay

Country Ledge & Dressed Fieldstone: Caramel & Brandywine,
Chardonnay & Chardonnay, Honey & Brandywine, Aspen & Aspen

DISCONTINUED MASONRY COLORS:

Eldorado Stone: "La Jolla" Coastal Ledge, "Santa Cruz" Coastal Ledge

Eldorado Stone: "Oakwood" Stacked Stone

Eldorado Stone: "Napa Valley" Weather Edge

Cultured Stone: "Fawn" Southern Ledge

Exhibit "am"
(continued)

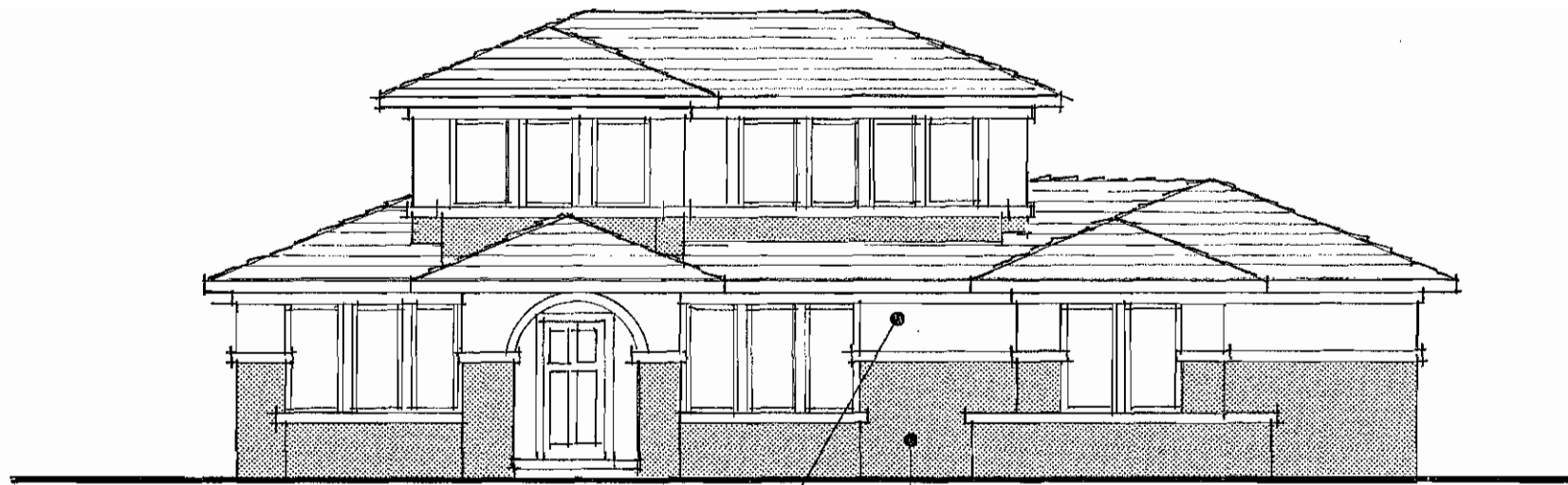

PRIMARY FIELD COLOR

SECONDARY FIELD COLOR

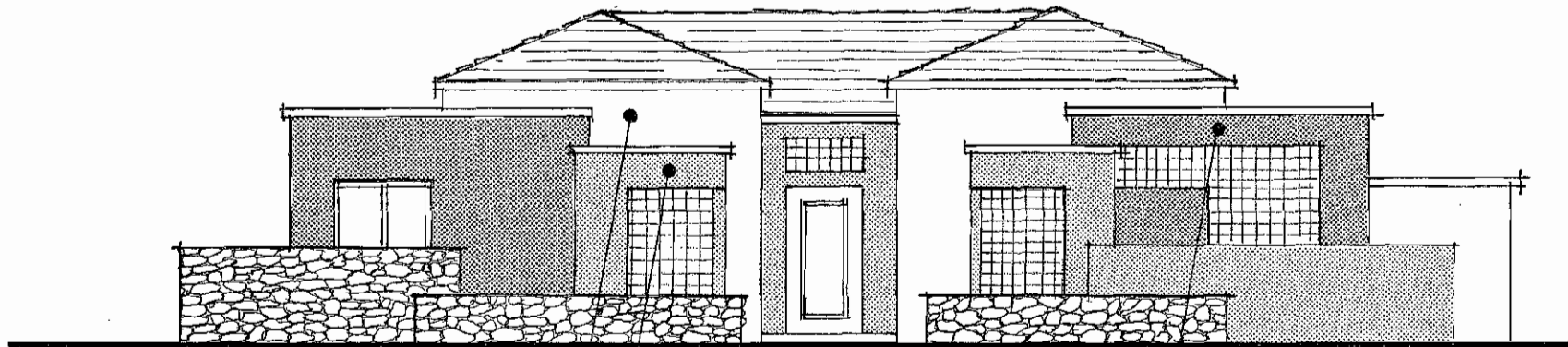

PRIMARY FIELD COLOR

SECONDARY FIELD COLOR

TERTIARY FIELD COLOR

3.4.12 Roof Design

Roofs are a significant component in the overall appearance of a building, and careful consideration must be undertaken to ensure that the design and scale of the roof is compatible with the architectural style of the dwelling and surrounding neighborhood. Roofs should be simple shapes without overly complex joining. Predominantly low to moderately pitched hip roofs are encouraged, with small portions of flat roofs permitted to enhance the desert character of the architecture. Roof articulation should strive to establish a relationship not only to the human scale, but should also enable the roof forms to blend into the natural desert environment.

3.4.12.a Roof Form and Slope: Low-pitched hip roofs are the predominant type of roof in Desert Elegance architecture. Roof pitches are not permitted to exceed a maximum slope of 4:12. Roofs with gable ends, used on a limited basis, are subject to review and approval by the Design Review Committee.

Pyramidal roof forms are often used to highlight architectural forms and floor plan elements of the residence.

Small portions of flat roofs used in conjunction with the low-pitched hip roofs further enhance the Desert Elegance character of the architecture. The use of flat roofs should be limited primarily to covering exterior spaces to minimize waterproofing constraints.

Flat roofs should be surrounded by parapets a minimum of 10" up to a maximum of 36" above the adjacent roof surface. Parapets must return and end in an intersection with a building mass.

Flat roofs that do not have parapets may be approved by the Design Review Committee if such roofs are free of any skylights, roof penetrations, roof vents, plumbing vents, or other similar elements, and if in the opinion of the Design Review Committee, any drainage crickets are not distracting to the overall design character of the residence. On flat roofs, the flashing detail between the roof and the parapet wall must be kept horizontal, not sloped to follow the roof or cricket slope, and all flashings must be painted to match the walls.

Roofs featuring broad overhangs are encouraged to provide shade protection from harsh desert climatic conditions. However, roof overhangs and/or cantilevered elements may not exceed more than 5'-0" into the side yard setback.

A variety in rooflines is encouraged to avoid a common roofline along the street scene. Rooflines of adjoining residences should vary ridge heights and the direction of main ridgelines to enhance the roofscape of the overall neighborhood.

Predominant roof ridgelines should be designed parallel to the natural contours of the site to minimize the visual impact of roofs and any gable ends.

Creatively designed skeletal roof structures offer the opportunity to provide shelter and shade while creating roof top color through the growth of vines and other plant material.

Skylights and roof top windows are permitted and should be designed as an integral part of the roof. In addition, these elements shall be tinted bronze or gray; white or clear glass is not allowed; and all framing material shall be colored to match the adjoining roof surface.

Several types of fascias are commonly used in Desert Elegance architecture. These include concealed, flush or tight fascias, as well as broad overhanging eaves providing protection from the sun.

Fascias may be either stucco, stone or tile. Corbel elements are non-characteristic of the Desert Elegance style of architecture and are not permitted.

3.4.12.b Roof Materials and Colors

Permitted Roof Materials:

Roof materials for each residence shall consist of one of the following in either flat tiles or concrete shakes:

- Concrete Tile
- Clay Tile
- Slate

Refer to Exterior Color Section for permitted roof colors.



MACDONALD
HIGHLANDS

Standing seam metal roofs, including patinaed copper, may be used, subject to approval by the Design Review Committee. Such roofs, however, shall have a matte finish to minimize glare.

Prohibited Roof Materials:

- Barrel or "S" Tiles
- Plain Red Tiles
- Asphalt Shingles
- Fiberglass Shingles
- Reflective roof surfaces causing excessive glare
- Simulated Tile including Fiberglass or Metal

Gutters and downspouts, when used, must be concealed unless designed as a continuous architectural feature. The use of patinaed copper gutters and downspouts is encouraged when used as an architectural feature.

3.4.12.c Mechanical Equipment Screening: Mechanical equipment such as air conditioners, heaters, evaporative coolers, television and radio antennas, satellite and radar receivers and other such devices shall not be permitted on any roof. Mechanical devices such as exhaust fans, vents and pipes shall be painted to match adjacent roof surfaces.

The use of solar panels, hot water storage systems, or other similar devices shall not be visible from any street or community open space, and are subject to approval by the Design Review Committee.

Air-conditioning units, etc. must be completely screened from view from adjacent lots, streets, or open space areas by a wall at least 12" higher than the equipment being screened within and must be setback a minimum of five feet (5') from all property lines. All utility meters and panels must be painted to match the adjacent building color at which they are located or must be located in service yards, mechanical rooms, or within meter closets. Utility panels in excess of 400-amps require a closet, which is to be integrated into the design of the residence. Executive Estate Lots requiring electrical panels in excess of 400-amps require prior Nevada Power Company written approval to ensure electrical needs for the residence are attainable. Said approval shall be included as part of the schematic plan submittal package.

3.4.13 Architectural Features and Accents:

The use of architectural features and accents is encouraged to create interest on building facades. Careful placement and treatment of accent windows, for example, not only reduces the scale of the building, but also adds character to the elevations. Stairways and columns should be carefully integrated into the design of the building. Accent colors and material treatments should complement the primary building color. Extreme contrasts in style, material and/or color should be avoided.

3.4.13.a Entry Courtyards: The use of front entry courtyards is encouraged as a transition from the public space of the street to the private dwelling.

The arrangement of interior living spaces can be used to enclose an entry courtyard, creating a focal point for surrounding rooms, as well as providing a charming entry to the residence.

In addition, garden walls and fences can be used in conjunction with the building architecture to create the entry courtyard.

Garden walls and fences, when used, should complement the adjacent finish and architectural character of the adjoining residence.

Garden walls should be embellished through the use of wall caps, ceramic tiles, steps, recesses, cutouts, and/or wrought iron details.

The use of gates or doors at the entrance to the courtyard is encouraged.

Plant material should be used to visually soften courtyard walls and fences.

3.4.13.b Walkways, Balconies, Terraces and Patios: Terraces and patios provide a strong indoor/outdoor relationship to the residence, enhancing the integration of the structure with the surrounding natural desert environment.

Broader verandas on both the front and rear elevations are important and shall be used to create appropriate design features.

Cantilevered balconies shall be wood, metal, or ornamental wrought iron and must be consistent in character and detail with the project and particular residence.

The generous use of windows and doors onto terrace and patio areas strengthens the visual continuity from interior living spaces to the out of doors.

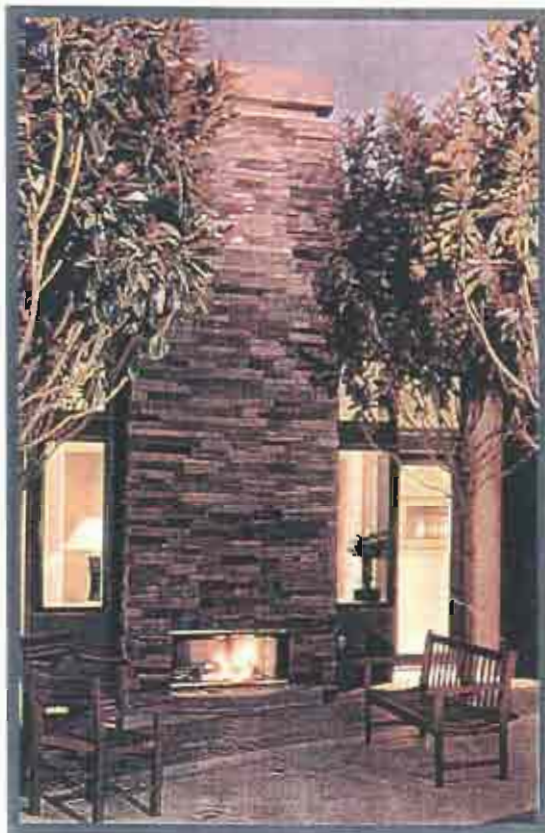
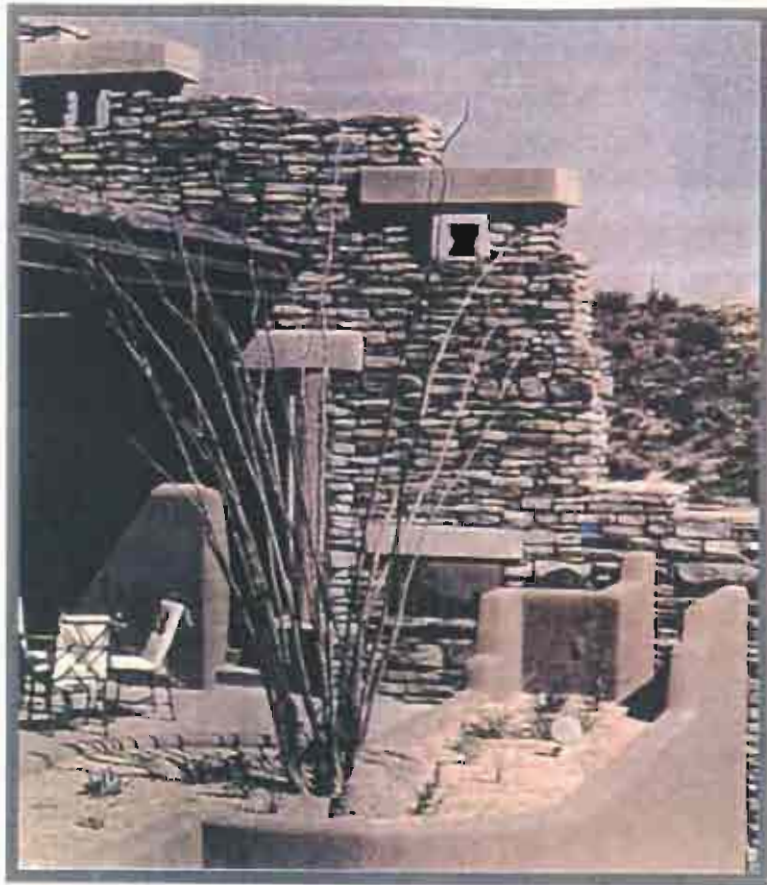

MACDONALD
HIGHLANDS

Exhibit "ap"
Page 3.94

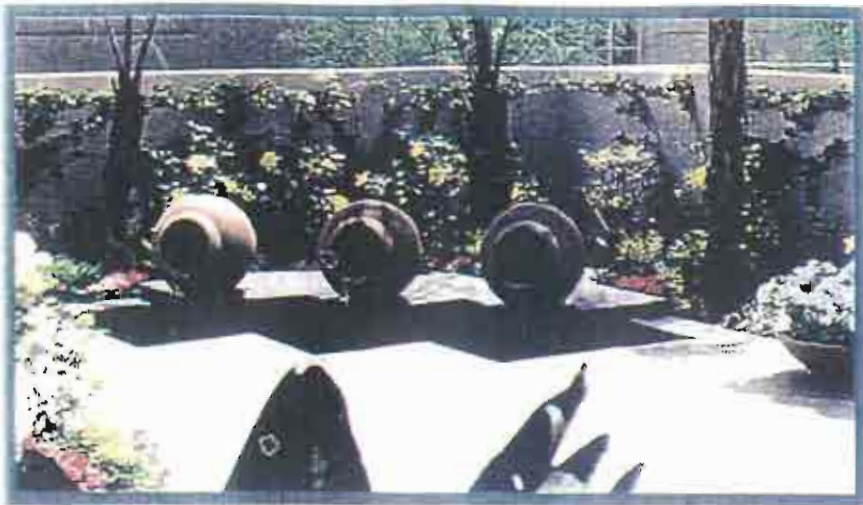

MACDONALD
HIGHLANDS

Exhibit "aq"
Page 3.95

An extension of the overall roof form to cover portions of the terrace and patio areas provides effective protection from the desert sun.

As rear patios, sun decks and “open” balconies are classified as non-livable spaces, these single-story elements will be permitted to encroach 10’-0” into the rear setback on Executive and Golf Estates, however, must comply with side setback criteria.

On Hillside and Manor Estates, rear patios and balconies will be permitted to encroach up to 15’-0” from the rear property line, but cannot exceed 15% of the overall rear yard area, and must comply with side setback criteria.

Broad roof overhangs and trellises also provide shade protection for terraces, patios, and the residential dwelling.

Walkways, terraces and patios should be constructed of materials that blend with the natural desert environment to the extent possible. Examples of such materials include stone, brick, and concrete colored to match the surrounding landscape. Ordinary concrete that is not colored or textured is not acceptable.

Tempered glass railings are permitted, however, their glazing must be either clear or tinted; reflective glass is not permitted.

- 3.4.13.c Windows:** Special consideration should be given to solar orientation when determining window locations and details. Windows with direct sun exposure should be shielded by covered patios, wide overhangs, deep window opening recesses, shade structures, tinted glass or other similar devices, to minimize the effects of the sun.

Large picture windows are effective in capturing the spectacular views offered from the site. The use of corner glass enhances the view opportunity within the residences and is characteristic of the Desert Elegance style of architecture.

The use of mullions is discouraged in the design of windows. Mullions, where approved by the Design Review Committee, may be used as an accent element.

Metal window frames are permitted, and may be bronze or earth tone colors compatible with the surrounding desert environment. Bright accent colors and mill finish frames are not permitted.

Window glazing may be either clear or tinted; reflective glass is not permitted.

3.4.13.d Screen Walls: Screen walls and fences shall be compatible with the architectural character of the residence in terms of design, material and color selections. They may be used to separate the Private Area from the rest of the Building Envelope and as screening for parking and service areas. They may not be used to arbitrarily delineate property lines or the Building Envelope.

In no case shall the height of a screen wall or site wall exceed 6-feet (per City of Henderson requirements), measured vertically from the lowest point at finished grade adjacent to the wall to the highest point of the wall along the exterior side of the enclosure, unless otherwise specifically approved by the Design Review Committee.

3.4.13.e Garage / Auto Courts: The placement of garages should carefully consider the impact of the garage doors on the streetscene.

The use of auto courts in which the garage doors are oriented completely away from the street is strongly encouraged. The auto court should be screened from view from the street, adjacent residences or public spaces through the arrangement of building elements, courtyard walls, gates or landscape material.

Detached garages must feature the same architectural style, materials, detailing and other characteristics as the main residence.

Garage doors shall be inset a minimum of 12" from the adjacent wall surface and should not be excessively ornamental. Roll-up garage doors are required; out-swing doors are not permitted. Copper doors, where permitted by the Design Review Committee, shall have a matte finish to minimize glare. Wood garage doors, where permitted by the Design Review Committee, must be maintained regularly. If problems occur with wood garage doors, the HOA and/or Design Review Committee reserve the right to require such doors to be replaced.

Garages, particularly when viewed from the street, shall feature offset garage doors to minimize their impact. For example, a 3-car garage shall feature one single garage door offset from the remaining two garage doors by a minimum of 3', or separated by a minimum of 12'.

3.4.13.f Parking: Each custom residence must have at least five parking spaces. Two of these spaces must be in a two-car garage that must be both enclosed and attached to the residence, or in a separate, totally enclosed structure. Carports are not permitted, except where enclosed on three sides and made an integral part of the structure. On-street parking is limited to visitors and guests only. Due to City of Henderson Fire Code, on-street parking is limited to one side of the street only. The approved street parking for visitors and guests will be limited to the southside and the eastside of the street only (*per MacDonald Highlands Master Association Rules and Regulations adopted July 10, 2002*).

3.4.13.g Chimneys: Chimneys shall be designed to be in scale and proportion with the architecture of the building, and incorporate materials consistent with the detailing of the building's elevations.

A chimney mass may not exceed an overall horizontal dimension of 12', unless otherwise specifically approved by the Design Review Committee. Unconcealed metal chimney terminations are not allowed.

Use of terra cotta or fabricated sheet metal enclosures is required for metal chimneys. Masonry chimneys must provide a cap detail that is consistent with the architectural character of the residence.

Chimney heights shall conform to City of Henderson standards.

3.4.13.h Building Projections: All projections from a building, but not limited to, chimney caps, vents, gutters, scuppers, downspouts, utility equipment, meters, boxes & connections, porches, railings, and exterior stairways shall match the color of the surface from which they project, or must be a compatible accent color, unless otherwise approved by the Design Review Committee.

3.4.13.i Accessory Structures: Accessory structures shall include any building or structure that is totally detached from the main building. Examples of these shall include, but are not limited to the following:

- Detached Garages
- Detached Guesthouses
- ~~Storage Buildings~~
- Equipment Enclosures
- Shade Structures including:
 - Gazebos
 - Cabanas
 - Trellises

Any accessory structure should be located and designed to respect the views, privacy, and other aspects of the adjacent properties. Such structures should be located and designed to be compatible with and compliment the design and form of the main residence. The use of mature landscaping is encouraged to soften the appearance of these structures.

Accessory structures provided on interior lots (i.e., fully-enclosed/non-visible lots) must be setback a minimum of five feet (5') from all property lines. While accessory structures provided on lots along the golf course and/or common open space must be setback a minimum of ten feet (10') from all property lines.

The height of an accessory structure will be reviewed by the DRC on a case-by-case basis as it impacts neighboring properties, the golf course and common open space.

3.4.13.j Flagpoles: Freestanding flagpoles are not allowed on any lot in MacDonald Highlands. Displaying the American flag, State of Nevada flag or other appropriate flag may be displayed on special occasions if it is hung from a pole bracket mounted to the residence or if it is suspended from a roof overhang.

3.4.13.k Service Areas: All above-ground trash containers, clotheslines, mechanical equipment, fuel tanks, water tanks, and other outdoor maintenance and service facilities must be completely screened from view from adjacent lots, streets, or open space areas by wall and gates at least 12" higher than the equipment. Gates, or a maze entry that provides complete screening, shall be required around all mechanical and pool equipment enclosures.

3.4.13.1 Utility Equipment: All utility meters and panels must be painted to match the adjacent building color at which they are located or must be located in service yards, mechanical rooms, or within meter closets. Utility panels in excess of 400-amps require a closet, which is to be integrated into the design of the residence. Executive Estate Lots requiring electrical panels in excess of 400-amps require prior Nevada Power Company written approval to ensure electrical needs for the residence is attainable. Said approval shall be included as part of the schematic plan submittal package.

3.4.13.m Unique Exterior Features: Unique exterior features including, but not limited to, entry arches, decorative gates, glass patterns, railings, enclosures, ramadas, gazebos, cabanas, exterior fireplaces, permanent BBQs, wet bars, water feature or water displays, or other similar features, must be designed as an integral part of the residence. Requests for approval of unique exterior features should include detailed design information including sketches, cut sheets, photographs, etc. submitted as part of the design review process with the Design Review Committee.

Specific restrictions include:

- Open railings on visible exterior stairs will be reviewed on a case-by-case basis at the sole discretion of the Design Review Committee. Exterior ornamental stairs are not allowed.
- Outdoor fireplaces, fire pits or similar items shall be gas fueled only to minimize the danger of fire. Gas units are permissible; however, it is the Owner's responsibility to ensure that all outside sources of emissions must conform to, and be permitted by, applicable federal, state and municipal environmental regulations in effect at the time of submission.
- Infinity/negative-edge swimming pools and/or spas, fountains, water features, water displays, outdoor fireplaces, fire pits, permanent BBQs, wet bars, etc. are limited in height to no higher than 5' above the grade at which they are located when visible from the golf course and/or common open space. If not visible, individual variance requests may be

considered by the DRC on a case-by-case basis, however, detailed design information including sketches, cut-sheets, photographs, etc. must accompany an Owner's request for variance and shall be submitted as part of the design review process with the DRC.

3.4.13.n Materials: Due to climatic extremes, the use of wood as an exterior material should be carefully considered. The use of wood on exterior walls as an accent is a high-maintenance item, and is prohibited as the primary exterior material. All exposed wood beams, fascias, columns, trellises, etc., should be of glulam construction. Expression of wood trim is generally used in lintels, porches, trellises, outlookers, and rafter tails.

- Plaster finishes with a hand-troweled finish or light-sand float finish is encouraged. Spanish Lace and other heavy textures are discouraged.
- Patinaed copper gutters and hidden down spouts are permitted and encouraged.

3.4.13.o Exterior Storage: Exterior storage shall only be permitted in the Side Yard if attached to primary structure or in the Rear Yard of any Lot or Parcel if in a totally enclosed Building or opaque screened area. Storage structures are not allowed along the golf course, common open space and hillside areas.

The height of the screened area shall be a minimum of six (6) feet (per City of Henderson requirements).

- 3.4.13.p Antennas/Satellite Dishes:** No antenna or other device such as satellite dishes, for the transmission or reception of television or radio signals or any other form of electromagnetic radiation shall be erected, used, or maintained outdoors on any Lot or Parcel, whether attached to a building or structure or otherwise, unless approved by the Design Review Committee.
- 3.4.13.q Solar Application:** Passive solar application, or the orientation and design of the Residence for maximum winter sun gain will reduce the winter heating needs, and will be encouraged. Solar collectors can result in excessive glare and reflection, and can only be approved by the Design Review Committee if they are integrated into the Structures or Landscaping on a Lot or Parcel and are not Visible from Neighboring Properties.
- 3.4.13.r Foundations:** All exterior wall materials must be continued down to finish grade thereby eliminating unfinished foundation walls.
- 3.4.13.s Additional Construction and/or Exterior Changes:** Any changes to the approved plans before, during, or after the construction of an Improvement *must first be submitted to the Design Review Committee for approval.* All submittals shall be accompanied by a cover letter, letter of transmittal or a copy of the Design Review Committee's "Application for an Alternation and/or Modification to an Existing Structure or Lot" describing the revisions proposed.

3.4.13.t Mailboxes: Mailbox designs were developed to provide consistency within the MacDonald Highlands community while conforming to its design philosophy; and to adhere to the specifications, and the installation, spacing and location requirements of the United States Postal Service. The mailboxes were chosen mainly for their rectilinear design characteristics, which echo the streetlight design of the community.

Community mailbox designs are as follows:

- Eisenhower Single Post, Model #N1017745, Color Black, available through Postal Products Unlimited Inc., Milwaukee, Wisconsin (800) 229-4500
- Grant Double Post, Model #N1017746, Color Black, available through Postal Products Unlimited Inc., Milwaukee, Wisconsin (800) 229-4500

When placing your order with Postal Products Unlimited reference QUOTATION #293646 and you will receive a discount on your order. The Sales Representative who handles the MacDonald Highlands Community is Brian Majewski at Extension 1017.

Address numerals for ***ALL*** mailboxes shall be uniform throughout the community. Numerals are available exclusively through Proffiti Signs & Graphics, Henderson, Nevada (702) 564-8087. The required font is “**Garamond Bold / Double Spaced / 1.5”-High / Color White**” and address numerals shall be installed on ***both sides*** of the Postal Products Unlimited Inc. mailbox unit, as shown below (names are not permitted).

Only address numerals are allowed on mailbox units; names are not permitted.



It is the responsibility of a Lot Owner to install the appropriate mailbox unit for each residence. If a double post is required (refer to Exhibit "ar" for site locations, and mailbox selection and specification requirements) both property owners will share the purchase and installation costs of the specified unit, and the first Lot Owner onsite shall coordinate the purchase and installation of said unit.

Only specified mailbox designs will be permitted in the MacDonald Highlands community and their locations **cannot** be changed unless approved by the Design Review Committee.

3.4.13.u Security: MacDonald Highlands is designed to allow the Association to provide an exclusive and private environment. The 24-hour, manned guardhouse and gates are constructed at the entrance to MacDonald Highlands.

A six-foot high wall will surround the north and west property boundaries. For entry, each Lot Owner will be allotted two (2) entry cards or keys to open the specially designed gate entry (additional cards or keys may be obtained upon request). As each Lot Owner approaches the guardhouse, the guard on duty will be able to control the gate entry for easier access into the community for its Residents. The Streets within MacDonald Highlands are private streets, thus minimizing street traffic and protecting Resident privacy.

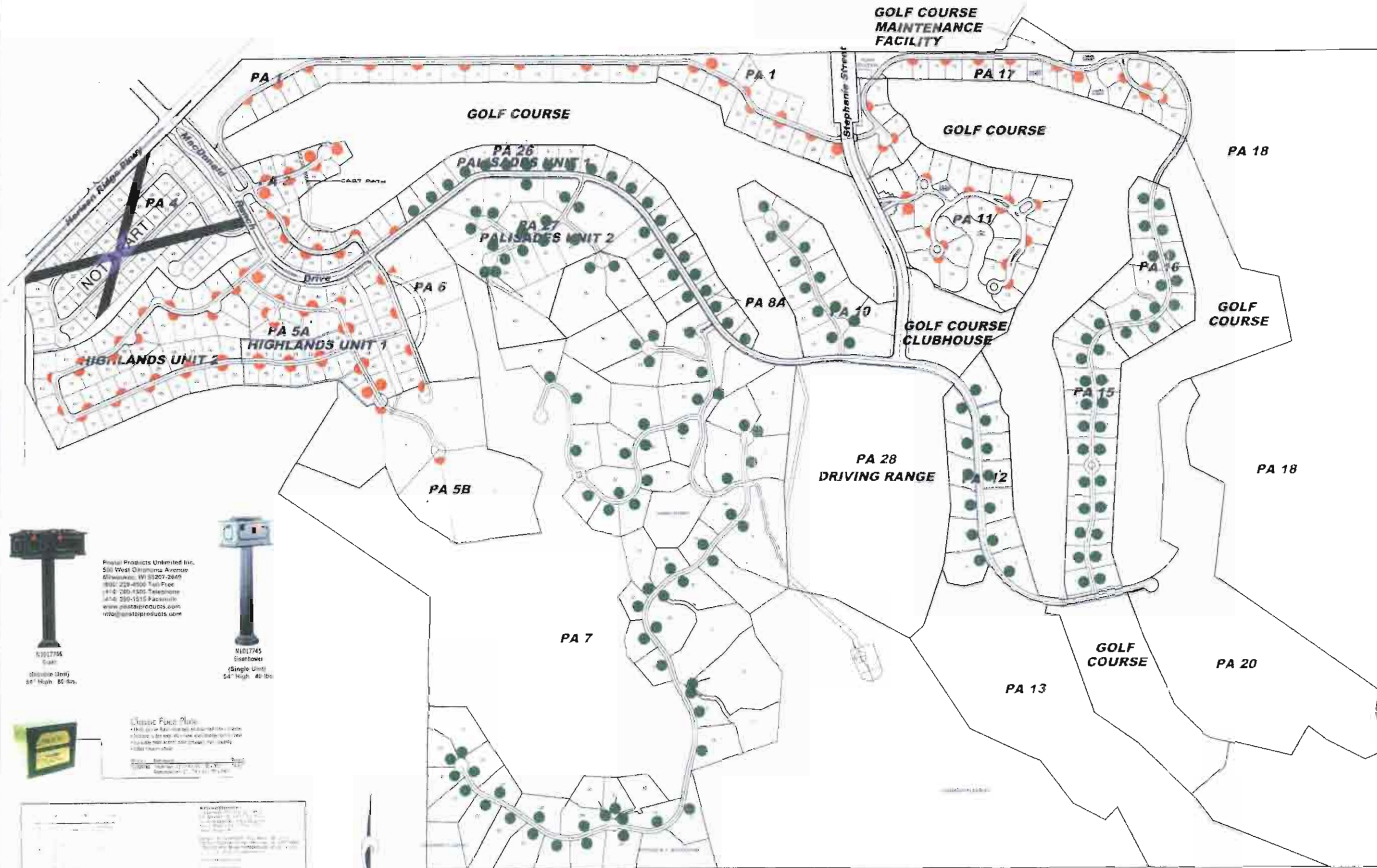

Postal Products Unlimited Inc.
 500 West Olinoma Avenue
 Milwaukee, WI 53207-2649
 (800) 229-4500 Toll Free
 (414) 280-1500 Telephone
 www.postalproducts.com
 info@postalproducts.com



Classic Post Plate
 • 11 1/2" deep
 • 11 1/2" wide
 • 11 1/2" high
 • 11 1/2" deep
 • 11 1/2" wide
 • 11 1/2" high

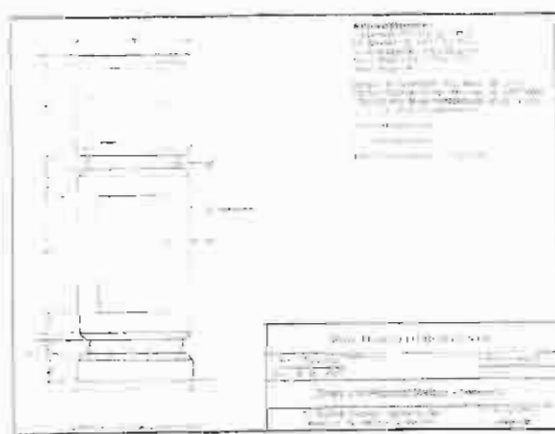

- 10 ● "Eisenhower" Single
- 100 ● "Grant" Double
- 1 ▼ Single / Double Combination
- 175 ● Custom Pedestal Cabinet



Parts of this exhibit are conceptual, developer reserves the right to change lot configurations at anytime. Exhibit "ar" Page 3.108

[MAIL BOX TYPE & LOCATION SITE PLAN]

MACDONALD HIGHLANDS

VPOINT

DATE: 04/11/2010
 TIME: 10:00 AM
 SHEET: 1 of 1
 SCALE: 1" = 100'

4.A.0 SITE PLANNING CRITERIA - ATTACHED HOUSING **(Planning Areas 13 & 20)**

4.A.1.1 Introduction

The natural topography, vegetation and setting of MacDonald Highlands creates a unique environment which requires careful attention throughout the site design and development process for the Multi – Family Attached housing neighborhoods in the community. Because attached housing generally requires larger structures than an individual single-family residence, the integrated design of site and structure is crucial to ensure that a harmonious relationship is achieved with the surrounding desert landscape. The design of attached housing neighborhoods must fully analyze the unique physical characteristics of the site, including topography, slope, views, drainage, vegetation, and access.

4.A.1.2 Building Envelope

The Building Envelope for multi-family attached product within MacDonald Highlands shall be defined as those front, rear and side setbacks established in Section 19.6.9.c(7) of the City of Henderson Development Code and shown on Table 19.3.4.1, Residential District Intensity and Dimensional Standards, located on Page 4A.3 of these guidelines.

4.A.1.3 Building Orientation

The Multi-Family Attached parcels within MacDonald Highlands have been designed to provide a sense of exclusivity to each of the neighborhoods. This exclusivity is further achieved through the ample sizing of these parcels to enable the creation of a pleasant neighborhood character with a sense of openness between structures. The siting of individual structures on the parcel should consider the following two primary factors: 1) View Orientation and 2) Relationship to the overall community. The Design Review

Committee will give extensive consideration to view corridors, impacts on adjacent homes and neighborhoods, solar orientation, drainage patterns, and impacts to existing site conditions.

4.A.1.3.a View Orientation: The hillside character of MacDonald Highlands provides spectacular view opportunities for most of the neighborhoods throughout the community. The orientation of major rooms, patios and terraces should be designed to take advantage of these dramatic views. The use of large picture windows and corner glass are especially effective in capturing the views offered by the site, and are characteristic of the Desert Elegance style of architecture. Buildings should be clustered around recreational and common open space elements, and sited to maximize both internal and external views.

With the golf course orientation of MacDonald Highlands, there is an inherent risk that golf balls and the play of golf may impact parcels or structures with golf course frontage. The Design Review Committee strongly recommends that careful consideration be given during the planning of site improvements, to the possibility of errant golf balls, particularly regarding the orientation of windows or other breakable surfaces of the structure. Netting, screens, excessive landscaping, fences or large blank walls will not be allowed. Evaluation of the proper siting, orientation, massing and setbacks should provide for maximum golf or view orientation with minimal adverse impact from the play of golf. Design consideration should also be given to the noise generated by golfers, golf carts and maintenance vehicles.

Table 19.3.4.1

Residential District Intensity and Dimensional Standards

Site Development Standard	Zoning Districts				Additional Regulations
	RS	RM	RH	RX	
Minimum District Size	N/A	RM-16 (Multifamily)=10 acres RM-8-E & RM-10-E=5 acres	10 acres	10 acres	
Maximum Density (units/gross acre)	RS-1A=1 RS-2=2 RS-4=4 RS-6=6	RM-8=8 RM-10=10 RM-16=16	RH-20=20 RH-24=24 RH-30=30 RH-36=36	RX-5=5 RX-8=8	7
Minimum Lot Dimensions					
Area (square feet)	RS-1A=40,000 RS-2=20,000 RS-4=10,000 RS-6=6,000 RS-6-PUD=5,000	RM-8-E=4,000 RM-10-E=4,000 RM-16 (Multifamily)=N/A	N/A	RX-5=6,000 RX-8=2,800	1, 2, 9
Width (feet)	RS-1A=100 RS-2=100 RS-4=75 RS-6=60 RS-6-PUD=50	RM-8-E & RM-10-E=40 RM-16 (Multifamily)=N/A	N/A	40-60	1, 8, 9
Minimum Setbacks (feet)					
Front	25, except RS-6=20 RS-6-PUD=Sec.19.5.4.E.8	RM-8-E & RM-10-E=20 RM-16 (Multifamily)=see Sec. 19.6.2.G.9	See Sec. 19.6.2.G.9	RX-5=20 RX-8=10	3, 5, 9
Interior Side	RS-1A=10 RS-2=10 RS-4=7.5 RS-6=5 RS-6-PUD=5	RM-8-E & RM-10-E=5 RM-16 (Multifamily)=see Sec. 19.6.2.G.9	See Sec. 19.6.2.G.9	RX-5=8 RX-8=0	4, 5, 9
Street Side	15, except RS-6=10 RS-6-PUD=Sec.19.5.4.E.8	RM-8-E & RM-10-E=10 RM-16 (Multifamily)=see Sec. 19.6.2.G.9	See Sec. 19.6.2.G.9	RX-5=12.5 RX-8=5	9
Rear	30, except RS-6=15 RS-6-PUD=15	RM-8-E & RM-10-E=10 (15 perimeter) RM-16 (Multifamily)=see Sec. 19.6.2.G.9	See Sec. 19.6.2.G.9	RX-5=15 RX-8=0	5, 9
Maximum Height (feet)	35	RM-8-E & RM-10-E=30 RM-16 (Multifamily)=35	35	15	6
Maximum Lot Coverage (percentage)	N/A	RM-16 (Multifamily)=40 RM-8-E & RM-10-E=N/A	40	40	
Minimum Spacing Between Units (feet)	N/A	RM-16 (Multifamily)=20 (30 window-to-window) RM-8-E & RM-10-E=10	20 (30 window-to-window)	RX-5=see additional regulations RX-8=15 side/side & end/end	10 11

4.A.1.3.b Relationship To Adjacent Lots & The Overall Community: Multi-Family Attached structures should be designed to blend into the overall character of the desert environment as much as possible, minimizing any negative visual impact from surrounding areas. The design of individual buildings should carefully consider the scale, proportion, and massing of building elements to ensure the resulting structure is compatible with the overall philosophy of MacDonald Highlands.

It is the intent of these guidelines to ensure that not only are the architectural designs consistent with community standards but that each new unit compliments and enhances those homes that already exist. An important aspect of the MacDonald Highlands philosophy is the goal of having the home fit within the existing terrain and not reconfigure the terrain to fit within the home. Careful consideration of the surrounding site conditions should be designed as an integral element of the lot's development. Therefore, the Design Review Committee will require all developers to provide the Design Review Committee with cross-sections as shown in Exhibit "V" (Section 3/Page 3.20). In addition to presenting the proposed elevations of the home, the cross-section must depict the proposed contours carried out to the lot lines.

Cross-sections are to be included in the Schematic Plan Review Submittal.

The building setbacks specified on Page 4A.3 are minimum requirements. It is strongly encouraged for the design of individual structures to incorporate additional setbacks, where appropriate, to further enhance the character of the neighborhood and to increase the distance between adjoining buildings and residences. The use of additional setbacks may be applied to certain structures to ensure specific siting issues are appropriately considered.

4.A.1.4 Parking And Driveway Criteria

Parking and driveway design standards shall be those set forth in the City of Henderson Development Code.

- 4.A.1.4.a Location:** Parking courts and driveways should be located in a manner, which minimizes their visual impact on significant natural features of the parcel such as vegetation, washes or drainage ways. They should also be located such that there is no interference with drainage in the street right of way.
- 4.A.1.4.b Materials:** All parking courts and driveways are required to be patterned concrete, stone, brick, bomanite, or other similar textured paving materials. The color of driveway materials must be compatible with the guidelines as outlined in Section 4A.2.5 of these design guidelines. Ordinary concrete without color or textural embellishment will not be allowed.
- 4.A.1.4.c Garage Placement:** It is encouraged for garage doors to be out of view from streets or other public spaces. Whenever possible, structures should be designed such that garage doors are located at right angles to the street. Where this is not possible, adequate landscaping shall be provided to soften the visual appearance of the garage doors.
- 4.A.1.4.d Parking Spaces Required:** Parking capacities shall conform to Section 19.6.2.c(10) of the City of Henderson Development Code.
- 4.A.1.4.e Repair Of Damages:** It shall be the lot owner's responsibility to repair existing streets, curbs, sidewalks, utilities, neighboring lots, or other existing elements, which may be damaged as a result of construction activity on the owner's lot.

4.A.1.5 Site Amenities

4.A.1.5.a Swimming Pools, Spas and Hardscape: Swimming pools, when provided, should be designed as a focal element for the neighborhood, but should be screened from direct view of neighboring properties. They must be constructed according to the City of Henderson Regulations and other applicable regulations, including required fence and enclosure heights. Doors and gates leading to swimming pools and spas must meet the City of Henderson safety and closure regulations.

Pool backwash or pool draining is not allowed to be disposed of in the sanitary sewer system nor, due to environmental concerns, is it allowed to be disposed of into a wash or other natural drainage area. Any applicable state, federal or City of Henderson regulations governing disposal of pool water must be followed.

4.A.1.5.b Tennis Courts: Tennis courts are subject to the review and approved by the Design Review Committee. When allowed, tennis courts should be fenced and sited for minimal visual impact from the street or from neighboring properties. The construction of tennis courts below grade helps to reduce the need for fencing. Lighting from tennis courts will not be permitted to spill onto adjacent property, and no tennis court lighting shall be installed without the approval of the Design Review Committee.

4.A.1.5.c Sports Courts: The location of all hard and soft surfaced dimensioned sport courts, such as basketball, racquetball, volleyball, and other similar facilities are subject to review and approval by the Design Review Committee. All such courts must have a minimum of a 10' setback from property walls to allow for light fixture placement and landscape screening. Lighting, if installed, shall be located, directed and shielded so that light rays and glare do not extend beyond the lot boundaries.

4.A.1.5.d Exterior Recreational Or Play Equipment and Pool Slides: All exterior recreational or play equipment such as swing sets, slides, play structures, jungle gyms, pool slides and other similar equipment must meet the intent and requirements of all sections of the Design Guidelines, including color. All exterior recreational or play equipment requires specific approval of the Design Review Committee prior to installation.

4.A.1.5.e Exterior Lighting: The goal of MacDonald Highlands, to preserve the visual character of the desert environment, extends to nighttime as well as daytime conditions. In order to preserve the dramatic views of the city lights and the night sky, which tend to be obscured by excessive local lighting, the following guidelines have been established for residential site lighting. Site lighting is defined as lighting mounted to the any exterior surface of the residence, ground, trees, site walls, fences or any other site feature for the purpose of providing security, decorative accent or functional lighting to outdoor spaces.

- Subtle, low-level lighting of landscape areas is encouraged. Landscape lighting, however, shall not intrude or produce a glare onto adjacent lots, lots across the street, or onto any public space. Landscape lighting must be directed downward onto vegetation or

prominent site features, and may not be used to light walls or building elements. All lighting must be directed toward the interior of the lot upon which it is located.

- Building mounted lighting must be directed downward away from adjacent lots, streets, and community open spaces, and may not be used to light walls or building elements for decorative purposes.
- All exterior lighting must provide for significant shielding to ensure that light sources and lamps are not visible from neighboring property; no bare lamps will be permitted.
- Recessed and soffit lighting in *entries, above garage door bays, and on patios and covered balconies* shall have a maximum wattage of 75 watts and the lamp must be recessed a minimum of 3" into the ceiling. Recessed lamps must also have a minimum 5' separation between fixtures.
- Only incandescent lamps with a maximum wattage of 75 watts will be allowed for exterior lighting unless specific approval is received from the Design Review Committee. Low voltage lighting is recommended, since these fixtures are typically small and can be easily concealed within the vegetation. Colored lights will not be allowed for exterior lighting.
- Tree lights are allowed, however, no chasing, twinkling or blinking lights are permitted.
- If problems occur with any exterior lighting, the HOA and/or Design Review Committee reserve the right to require such fixtures be disconnected.

4.A.1.6 Hillside Design Criteria

Site Design: The Multi-Family Attached neighborhoods are characterized by sloping topography which provides many challenges as well as opportunities. While hillside development offers dramatic view opportunities, it also creates highly visible elements on the landscape itself. Therefore, careful consideration must be undertaken to ensure that hillside architecture blends naturally into the surrounding desert environment. Upon completion of construction, the finished grade around the buildings and site walls should lie against the walls, as near as possible, to the original angle of slope.

Building heights may be increased in order to minimize the impact of mass grading and/or to reduce site coverage. The focus will be not only to minimize site disturbance but also to restore and improve landscape coverage in areas that are disturbed.

During the preparation of a preliminary site plan for the neighborhood, consideration should be given to the impact of the proposed buildings and site improvements on neighboring properties regarding privacy, view preservation, natural drainage, and ease of access.

While the natural topography of MacDonald Highlands varies considerably between neighborhoods, the following general limitations apply, unless the Design Review Committee approves special circumstances supporting an exception:

- No change in natural or existing drainage patterns for surface water shall be made that could adversely affect adjacent properties.
- Retaining walls and other walls not directly supporting a building structure, except screen walls, shall typically not exceed 8 feet in height, measured vertically from the lowest finished grade adjacent to the wall along the exterior side of

the enclosure. Where additional height is necessary, and subject to approval by the Design Review Committee, retaining walls must be terraced with a minimum separation of 4 feet between walls and an overall height not to exceed 24 feet. Subject to approval by the Design Review Committee, other acceptable methods for minimizing the impact of retaining walls greater than 8 feet in height include: landscaping with mature indigenous trees or large shrubs; and/or using a different texture and/or material such as stone for a portion of the wall treated to blend with the natural terrain.

- Screen walls, walls not supporting a building structure or retaining earth, may not exceed 6-feet in height (per City of Henderson requirements) measured from finish grade along the exterior side of the enclosure in the manner described above for retaining walls.
- Stone used as a landscape material shall be 1" or less in size, and shall match the color of the existing native stone on the homesite. Rounded pea gravel may not be used as a landscape or driveway material.
- Native stone indigenous to the site is allowed for riprap or other landscape treatments, as well as river rock stained to match the native stone.

4.A.1.7 Parcel Grading And Drainage

Parcel grading and drainage should be done with a minimum disruption to the site. Structures, roads, driveways and any other site improvements should be designed to fit the existing contours of the site, minimizing the amount of excavation required rather than altering the site to fit a non-responsive structure or improvement onto the site.

Surface drainage shall not flow to adjacent properties or open spaces except as established by existing natural drainage patterns, or cause a condition that could lead to off-site soil erosion onto such areas.

The design of site improvements should carefully evaluate the potential for erosion based upon the percentage and direction of slope, soil type and vegetation cover. When a change in the natural drainage within a parcel is necessary, right angle diversions should be avoided, but rather should create positive drainage in a logical and natural manner. The potential for erosion should be minimized through the use of native rock, plant material, and/or rip rap in disturbed areas. Any changes in a drainage pattern require contour grading and mature landscape to return the drainage way to its natural appearance.

Drainage facilities shall be designed to maintain the natural run-off characteristics. Drainage facilities shall be designed in accordance with the Clark County Regional Flood Control District Hydrologic Criteria and Drainage Design manual. Private drainage facilities, cross lot drainage easements or rear lot drainage easements shall be privately maintained.

Extensive grading activity on a development parcel within MacDonald Highlands is discouraged. Culverts, when used, should be concrete with exposed surfaces treated with PERMEON to match the adjacent natural landscape of the desert. In addition, end walls or other terminal structures should be similarly treated.

Where grading is unavoidable, careful consideration should be given to the impact to the natural appearance of the surrounding landscape. The following measures should be used to minimize negative visual effects of site grading, including:

- Exposed escarpments shall not exceed 2:1 in slope except as otherwise approved by a licensed Geotechnical Engineer. In order to provide a natural appearance to such escarpments, the slopes should be varied (2:1, 3:1, 4:1 & 5:1) providing an undulating appearance.

- Cut and Fill conditions in excess of 2:1 slope shall use riprap or other rock-type erosion control methods, subject to City of Henderson approval. Riprap or other erosion control features shall be stained with PERMEON to match the surrounding conditions of the natural desert environment.
- Smooth transitions between escarpments and natural topography are required at the top and toe of such slopes by rounding the transition areas.
- Disturbed areas should be reshaped to duplicate the original natural slope to the extent feasible.
- Disturbed areas should incorporate erosion control measures such as landscaping, riprap, or other similar techniques, as approved by the Design Review Committee and the City of Henderson.
- The grading of a development parcel should respect the existing natural drainage conditions of the site. Where feasible, existing drainage channels should be maintained in their natural condition.

4.A.1.8 Retaining Walls

The use of retaining walls may be necessary in certain graded conditions, and the maximum height of the block portion of the retaining wall cannot exceed 8 feet in height.

Where additional height is necessary, retaining walls must be terraced with a minimum separation of 4' between walls to allow for adequate landscaping. The maximum height of the block portion of an individual retaining wall in a terraced condition remains at 8 feet.

Open railings up to an additional 3' in height may be allowed on top of a maximum 8' high retaining wall, subject to approval by the Design Review Committee. The Design Review Committee must specifically approve the design of such railings. The maximum height of a

retaining wall with iron is 11'-0". However, if the height of the retaining wall is minimized the height of the iron may be increased accordingly, not to exceed a combined height of 11'-0".

Retaining walls should follow the existing contours of the site to ensure a natural blending into the surrounding desert environment.

Retaining walls should have a natural appearance through the use of such materials as stone, brick, split-face CMU, "rockery walls" or slump-stone colored to match the adjacent structure or a color that is compatible with the surrounding desert landscape. Precision-cut concrete blocks or exposed concrete retaining walls will not be permitted.

4.A.1.9 Vehicular Circulation

Within the hillside neighborhoods, all roadways whether public or private, shall be designed according to the standards described in Section 4.A.1.10, as well as AASHTO requirements. The standards are also intended to supplement the Public Works Department Plan Review Guidelines. Roadways should be located such that impacts to the natural environment are avoided.

Roadways, parking courts, and driveways should follow the topography of the area to minimize grading cuts and fills. Curvilinear horizontal alignments and gently rolling profiles consistent with the natural topography will minimize unnecessary site disturbance. Significant features such as rock outcroppings should be avoided. In the event that rock outcroppings are unavoidable the Developer of the multi-family parcel shall treat them with PERMEON to match the desert landscaping.

Driveways must meet or exceed those standards established by the City of Henderson Development Code and the City of Henderson Fire Department.

4.A.1.10 ROADWAY STANDARDS

For roadways serving greater than 100 residential units, the design criteria shall be reviewed on a case-by-case basis with the City of Henderson Public Works Department.

For roadways serving 100 or fewer units, the following standards shall apply:

Right of Way:	42 ft (no parking or parking one side) 45 ft (parking on both sides)
Travel Lanes:	2
Face of Curb Dimension:	24 feet (no on-street parking) 28 feet (parking on one side) 36 feet (parking on both sides)
Curbing	Curbing shall be required. (Curb type shall be as approved by the City Engineer)
Design Speed:	20 miles per hour
Stopping Site Distance:	125 feet
Site Distance (intersections):	200 feet
Minimum Center Line Radius (w/o Superelevation):	180 feet
Minimum Center Line Radius (w/2% Superelevation):	140 feet
Minimum Grade:	0.4%
Maximum Grade:	15%, except that a fire apparatus road within 50 feet of a structure, the grade shall not exceed 8%. In lieu of providing an 8% roadway grade within 50 feet of a structure, the structure shall have a full building fire sprinkler system per City of Henderson Fire Department requirements.
Maximum Grade Length:	7 - 9%: 1400 feet 9 - 12%: 700 feet 12 - 15%: 350 feet
Minimum Curve Length:	100 feet
Vertical Clearance:	13.6 feet
Sidewalks:	Minimum lot sizes less than 20,000 sq. ft.: 4' walk; one-side only Minimum lot sizes greater than 20,000 sq. ft.: No sidewalk required
Cul-de-sacs:	Radius (45 foot measured to the face of curb)
Maximum Units Served:	25.
Vertical Curves	Required if grade difference exceeds 1%.
Roadway Aprons:	2% maximum slope measured 4 feet from the back of curb on both sides of the street.
Right of Way Slope:	3 feet horizontal for 1 foot vertical behind the roadway apron and within the right of way.
Cross Slopes:	4%
Street Lighting:	Intersections and other locations for public safety as required by the City of Henderson Public Works.
Intersection Spacing:	200 feet, measured centerline to centerline.

4.A.1.11 WATER (Public Works)

Water System Design: All water systems shall be designed in accordance with the Uniform Design and Construction Standards for Water Distribution Systems, Clark County and the Uniform Standard Specifications for Public Works Construction, Clark County area.

4.A.1.12 WATER (Fire Department)

4.A.1.12.a Water System Flow: The water mains and the distribution system shall be designed to deliver a minimum residual pressure of 20 pounds per square inch (psi) at the fire hydrants in service during maximum day demand plus the required fire flow demand. Minimum fire flow shall be equal to 750 gallons per minute (gpm) for residential property classified as a Group R, Division 3 occupancy. All other occupancies shall be as prescribed by the Fire Code. The system shall be designed to provide a minimum of 40 psi during peak hour conditions without fire flow. A maximum pressure delivery at the point of service shall not exceed 120 psi.

4.A.1.12.b Building Fire Sprinkler Systems: All buildings shall be provided with an approved automatic fire sprinkler system in accordance with the Fire Code in effect at the time of plan submittal. Neither The Foothills Partners nor MacDonald Highlands Realty shall be held liable for any revisions that the City of Henderson Fire Department shall make to fire sprinkler requirements. The water system design shall accommodate the requirements for building fire sprinkler systems. The building fire sprinkler system shall meet City of

Henderson requirements, in addition to the Fire Code requirements.

(Based upon steeper road grades, reduced roadway design speeds, reduced roadway width, longer dead ends and cul-de-sacs, reduced water system design requirements and relaxed secondary access requirements, the response time for emergency vehicles is increased above that of conventional development patterns within the City of Henderson. Given the increased response time, a waiver of the requirement for building sprinkler systems is subject to review and approval by the Fire Marshal.)

4.A.1.12.c Water Main Sizes: Residential water main sizes shall be a minimum of 6 inches in diameter or as required by the City of Henderson Public Works Department. If minimum fire flow requirements are met, fire hydrant branch lines shall not be required to be looped.

4.A.1.12.d Fire Hydrant Branch Lines: Fire hydrant branch lines shall be set at right angles to street mains. The hydrant shall be set at the end of the branch line and shall face the branch. No horizontal or vertical bends or reducers shall be used in installing fire hydrant branch lines unless specifically approved by the City of Henderson. Under no circumstances shall any size or manner of tap be made on a fire hydrant branch line.

4.A.1.12.e Fire Hydrant Location and Distribution: The number and spacing of fire hydrants shall meet the approval of the Fire Prevention Division. Fire hydrants shall be located adjacent to and accessible from fire apparatus access roads. Fire hydrants shall be located along fire apparatus roads as follows:

- Spacing of fire hydrants shall normally start by placing fire hydrants at all intersections or;

- In all residential areas, fire hydrants shall not be spaced greater than 750 feet apart, or;
- The maximum distance from a Group R, Division 3 Occupancy to a fire hydrant shall not exceed 500 feet, as measured from an approved point on a street or road frontage to a fire hydrant.

4.A.1.13 Wastewater Collection And Treatment

Wastewater collection systems shall be designed in accordance with the Design and Construction Standards for Wastewater Collection Systems, Clark County, 1991 and the Uniform Standard Specifications for Public Works Construction, Clark County area. Septic systems shall not be permitted.

4.A.1.14 Homeowners Association

Each hillside development plan that provides for private streets or improvements, common areas or natural areas shall establish and maintain a Homeowners Association. The association shall be responsible for the maintenance and upkeep of all private streets and improvements as well as all common and natural areas.

Natural areas may be designated as a deed-restricted portion of a privately owned lot, or as a separate parcel. Such parcel may be under the ownership of a homeowner's association or deeded to any organization, which accepts responsibility for the perpetual preservation and maintenance of the natural area, subject to approval and acceptance by the City of Henderson. To protect the natural areas, covenants that run with the land, shall be recorded in favor of the City of Henderson and of all owners with record interest in the natural area.

4.A.1.15 Hillside Architecture

The sloping topography of a hillside neighborhood provides many challenges as well as opportunities. While hillside development offers dramatic view opportunities, it also creates highly visible elements on the landscape itself. Therefore careful consideration must be undertaken to ensure that hillside architecture blends naturally into the surrounding desert environment.

The terrain in MacDonald Highlands provides a variety of landform and slope conditions throughout the community, requiring different Cut and Fill treatments depending on specific conditions, to ensure that the Single Family Attached structures are well-integrated with the site. The following guidelines address the general Cut and Fill situations. Evaluation of the proposed site improvements will be based on conformance with these Cut and Fill guidelines. The Design Review Committee reserves the right to request that the proposed finish floor elevations be adjusted due to Cut and Fill conditions regardless of compliance with Building Height requirements.

Cut and Fill conditions must meet the intent and goals of these guidelines as well as their technical application. The Design Review Committee may allow exceptions to the technical Cut and Fill guidelines when, in the opinion of the Design Review Committee, the objectives and intent of the Guidelines are still met.

All Cut and Fill excavations must occur within the parcel and any excess fill material must be removed from MacDonald Highlands and disposed of in accordance with the requirements of the City of Henderson. Excavated material shall not impact natural areas, nor be disposed over a hillside within MacDonald Highlands.

The building mass of individual structures should be compatible with the existing natural landforms of the site and surrounding area. This can be effectively accomplished by separating the structure into a series of smaller building forms that conform to the natural topography of the site.

Predominant roof ridgelines should be designed parallel to the natural contours of the site to minimize the visual impact of roofs and gable ends.

Materials and colors should be selected on their ability to blend into the surrounding desert landscape.

4.A.1.16 View Preservation

The hillside character of MacDonald Highlands provides spectacular view opportunities for most of the single family attached neighborhoods throughout the community. The orientation of major rooms, patios and terraces should be designed to take advantage of these dramatic views.

The existing terrain provides the opportunity to create multi-level structures that terrace down the hillside, in either a townhome or stacked flat configuration. This terracing allows views to be captured from each level of the building.

While views should be maximized from individual neighborhoods, the buildings should be designed and sited such that view opportunities from surrounding lots are not obstructed.

4.A.2 ARCHITECTURAL DESIGN CRITERIA - ATTACHED HOUSING (Planning Areas 13 & 20)

4.A.2.1 Architectural Character

The primary goal for the design of Single Family Attached residences within MacDonald Highlands is to create a structure that integrates the architecture of the building with the natural character of the surrounding desert landscape. The resulting architectural style is best described as "Desert Elegance", exemplified by strong horizontal building forms with a minimum of ornamentation. This integration of architecture to the site is further enhanced through the extensive use of terraces and courtyards providing a strong indoor/outdoor relationship to the building's residences. Finally, the proper use of color is crucial for the successful design of the structure. Building colors should be selected for their ability to blend naturally into the desert environment, such as "earthy" tones of buff, sand, beige, gray and other similar hues. Bold color schemes featuring crisp whites, pastels, or bright colors will not be permitted.

The purpose of the Architectural Design Criteria is to ensure that the architectural character of the attached residential neighborhoods is compatible with that of the overall character envisioned for MacDonald Highlands, while encouraging unique, innovative and creative design solutions. Individual consideration will be given to the aesthetic and physical relationships of the building to the site.

4.A.2.2 Architectural Components

BUILDING FACADES	ROOFS	ARCHITECTURAL FEATURES/ ACCENTS
<ul style="list-style-type: none">▪ FORM / MASS▪ COURTS / PORCHES▪ SHADOW OPENINGS▪ MATERIALS / TEXTURE	<ul style="list-style-type: none">▪ ROOF PITCH▪ OVERHANGS▪ MATERIALS	<ul style="list-style-type: none">▪ ACCENT WINDOWS / DOORS▪ DECKS / PATIOS▪ FENCES / WALLS▪ ACCENT COLOR / TREATMENTS

The architecture of attached residential dwellings can be broken down into three major components, including 1) Building Facades, 2) Roofs, and 3) Architectural Features & Accents. The proper design treatment of these three components will result in a visually pleasing residence and neighborhood environment throughout MacDonald Highlands. The following is a general description of how each of these components should be addressed relating to the Desert Elegance architectural style.

4.A.2.3 Building Facades

The three dimensional success of a building and its site elements is a result of the careful treatment of building mass, proportion and scale, articulated by a variation in texture, materials, and color treatment. In general, large unarticulated building masses should be avoided because of the resulting scale, which would be out of balance in achieving a desirable relationship to the desert environment. Structures that require greater amounts of space, should have vertical and horizontal offsets to break up the building mass and create a more desirable scale and visual interest to the dwelling. The interplay of shade and shadow, along with texture and openings in large building surfaces provides interest and balance to the building. In addition, the use of terraces, porches and balconies, window and entry treatments further emphasize building articulation. Together, each of these elements enable the creation of Multi-Family Attached residential neighborhoods, which blend harmoniously into the natural desert environment.

4.A.2.4 Building Massing And Scale

The Desert Elegance architectural style features a strong horizontal character achieved through the predominant use of one-story building forms.

4.A.2.4.a Building Height: the design of the Single Family Attached residences should carefully consider the existing site conditions, and should be designed as an integral element of the landscape. Stacking is encouraged to minimize site disturbance.

Height requirements for multi-family attached product shall be those set forth in Section 19.6.2.c(9) of the City of Henderson Development Code, excepting those areas where a maximum ridgeline of 45' will reduce overall site disturbance, subject to City of Henderson-approval.

All height limitation criteria form the basis of general massing only. For example, it is expected that all elevations will not only take advantage of the view from within the residence, but will also provide pleasant views from all surrounding areas, as well. All side and rear elevations should be articulated to break up the facade into smaller elements, as well as adding the richness of shade and shadow. Large blank walls will not be allowed. Failure to provide adequate articulation and richness may be grounds for rejection of the design by the Design Review Committee.

4.A.2.4.b Massing: The proper massing of Desert Elegance architecture will reduce the visual scale of a large structure, and create a texture, which helps blend the building with the surrounding natural environment.

Buildings should be composed of clusters of simple rectangular-volume building forms, arranged in an asymmetrical manner, and should feature multi-levels terraced to existing topographic conditions.

4.A.2.4.c Articulation: The horizontal character of Desert Elegance architecture is enhanced by the integral design of outdoor living spaces such as terraces and patios as a transition between the building's residences and the natural landscape environment. Extended roof forms and broad overhangs are often used to provide cover for these spaces, protecting them from the harsh climatic conditions of the desert.

The horizontal character of Desert Elegance architecture is further enhanced by the use of articulated roof forms combining low pitched hip roofs and flat roof forms. The zoned activity areas are often highlighted by the use of pyramidal roof forms.

4.A.2.5 Exterior Materials

Exterior surfaces shall generally be of natural material that blend with and are compatible with the natural landscape. Materials should be selected based on their ability to withstand the extreme climatic conditions of the desert. Exterior building walls shall consist of at least one, but not more than three of the following:

- Stone such as the following:
 - Granite (Thermal or Honed Finish)
 - Arizona Sandstone (Thermal or Honed Finish)
 - Slate (Cleft Finish)
- Split-face CMU block of earth tone colors compatible with the surrounding desert environment
- Brick (clay)
- Stucco or plaster with a light to medium texture, such as dash, smooth, sand or lace. (Heavy textures such as swirl or heavy trowel are prohibited.)
- Glass / Glass Block

Large expanses of painted surfaces, particularly wood, will not weather well in desert conditions and will not be approved.

All residences shall feature "wrap-around" architecture that is all four sides of the building shall have a consistent level of detail in terms of materials and architectural detailing. The purpose of this requirement is to ensure that all elevations of a Residence will be considered equally during the evaluation and review process, particularly for those residences with frontage on the golf course or other public spaces.

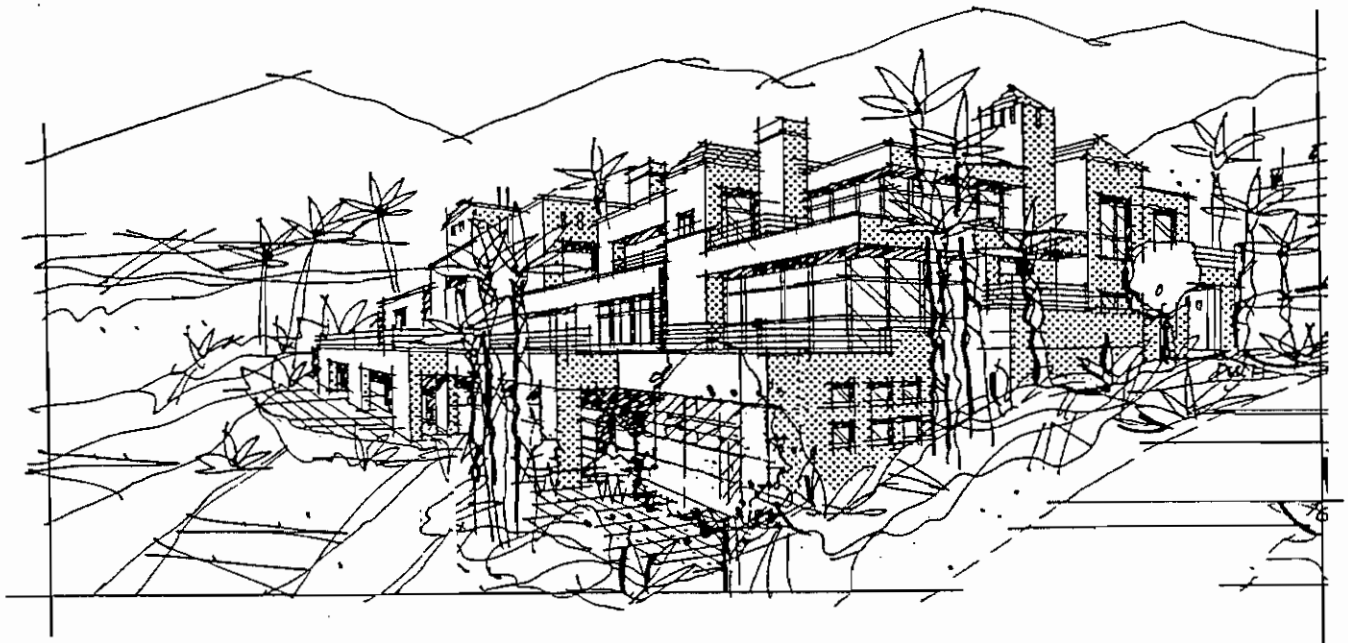

BUILDING FACADES—MASS EXHIBIT

Exhibit “as”

All surface treatments or materials shall be designed to appear as an integral part of the design, and not merely applied. All materials shall wrap columns, porches, or balconies in their entirety. Material wainscoting (i.e., the application of stone along the lower portion of an elevation) and random patterns are not preferred—applying masonry material in massed elements is more appropriate to the Desert Elegance architectural theme of the community.

Material changes (where proposed) should occur at inside corners. Siding materials shall be continuous to within 6" of finished grade. Exposed footings are not permitted.

Highly reflective finishes (except glass) shall not be used on any exterior surfaces.

4.A.2.6 Color Overview

Nestled in the McCullough Mountain range, the community of MacDonald Highlands has a unique natural setting. Building colors and materials must be in muted desert shades in order to blend the residences harmoniously into the surrounding desert landscape. To help builders and architects achieve this goal, MacDonald Highlands has developed a color program that:

- Identifies appropriate colors.
- Outlines criteria for color selection.
- Gives guidelines for color implementation.

All builders and architects shall utilize this color program in the planning and execution of exterior finishes.

4.A.2.7 Color Program

Roof, field, and masonry color palettes have been identified for use at MacDonald Highlands. Builders are required to make their selections from these palettes, however, additional colors and color combinations may be considered by the Design Review Committee provided the alternate color(s) complies with community-specified light reflectance value ranges, and is consistent with and compliments the natural surroundings. Final approval or disapproval of alternate paint colors and/or color combinations will be judged at the sole discretion of the Design Review Committee.

The community-approved palettes are defined by the following criteria:

- Roof colors that are flashed or modeled and have a medium light reflectance value (LRV).
- Field colors that are muted shades with a light reflectance value (LRV) between 60% and 15%.
- Masonry materials that are natural in form and compatible in color with the desert environment.

Multi-Family Parcels Are Strictly Limited To Use Of The Upper Hillside Color Palette.

The Upper Hillside areas may only use the colors in the Field Color Palette with a LRV between 55% and 25% for the primary field colors. However, secondary field colors in the Upper Hillside areas may be selected from any color in the Field Color Palette. Exhibit "at" (Pages 4B.73-76) provides a full listing of all approved roof, field and masonry (faux) materials.

The remaining colors to be identified for a residential color scheme, fascia, trim, garage door & accent must also be in muted shades that blend appropriately with the desert environment. These colors may be selected by the builder or architect, from their own source, as long as they maintain a LRV of 70% or less and will be reviewed by the Design Review Committee.

4.A.2.8 Color Palette Design Kit

A “Color Palette Design Kit” (Design Kit) has been created for use by the builders and architects in MacDonald Highlands to assist them with their selections from the defined roof, field and masonry palettes. Each Kit contains a color fan deck of the Field Color Palette as well as a listing of the approved roof and masonry colors. Within the Field Color Palette, the Upper Hillside primary field color options will be identified by shortened paint chips. Listed on the front of each chip in the fan deck is the manufacturer’s reference number, name and light reflectance value (LRV).

FRAZEE PAINT was selected for use in the Design Kit, *however, manufacturer crossovers are acceptable so long as the corresponding Frazee number, name and LRV are noted when submitting a color package or scheme to the Design Review Committee for review.*

4.A.2.9 Builder Color Requirements

Builder color palettes shall utilize the following guidelines:

4.A.2.9.a Color Scheme Number:

- Attached Housing shall have three-color schemes minimum.

4.A.2.9.b Roof Colors: Roof colors shall be selected from the defined palette. *Manufacturer crossovers are acceptable only if they maintain the roof color criteria.*

- Attached Housing projects shall have one roof color or blend.

4.A.2.9.c Building Colors: Each color scheme shall have a minimum of three different colors not counting the roof or any masonry material. All field colors shall be different with a discernable difference between them. Schemes utilizing a primary and secondary field color shall have a 15% LRV spread between them. Only one third of the color schemes may use the same fascia color. Only one third of the color schemes may use the same trim color. All accent colors are to be different.

4.A.2.9.d Masonry:

- Attached Housing projects shall have a masonry material integral to the design of the project.

4.A.2.9.e **Color Plotting:** In an effort to offer the most balanced blend of materials and colors as possible, adjacent and facing residences shall not have the same front or rear elevation and shall not have the same color scheme. However, opposite hand footprints with variations in elevation design elements and a different color scheme will be permitted.

4.A.2.10 Color Submittals

Submittals for Builder color packages to the Design Review Committee must contain the following information:

A color and material sample board showing the selected building colors, roof and masonry material. The Frazee paint reference number, name and LRV must be identified on the board. *Paint crossovers must list the Frazee color as well.*

When multiple field colors are used, exterior elevations showing the color application strategy shall be submitted (i.e., Color Blocking Exhibits). See Exhibit "au" (Page 4 B.77) for submittal example.

Manufacturer cut sheets, photographs or samples of any materials, which require further or more detailed explanation such as: lighting, special ornamentation elements, custom gates, etc.

4.A.2.11 Roof Design

Roofs are a significant component in the overall appearance of a building, and careful consideration must be undertaken to ensure that the design and scale of the roof is compatible with the architectural style of the building and context of the overall MacDonald Highlands community. Roofs should be simple shapes without overly complex joining. Predominantly low to moderately pitched hip roofs are encouraged, with small portions of flat roofs permitted to enhance the desert character of the architecture. Roof articulation should enable the roof forms to blend into the natural desert environment.

4.A.2.11.a Roof Form and Slope: Multiple roof forms are encouraged which emphasize the overall simplicity of the building's form.

Low-pitched hip roofs are the predominant type of roof in Desert Elegance architecture. Roof pitches on multi-family attached product shall not exceed a maximum slope of 6:12.

Pyramidal roof forms are often used to highlight architectural forms and floor plan elements of the building.

Small portions of flat roofs used in conjunction with the low-pitched hip roofs further enhance the Desert Elegance character of the architecture. The use of flat roofs should be limited primarily to covering exterior spaces to minimize waterproofing constraints.

Parapets a minimum of 10" up to a maximum of 36" above the adjacent roof surface should surround flat roofs. Parapets must return and end in an intersection with a building mass.

Flat roofs that do not have parapets may be approved by the Design Review Committee if such roofs are free of any skylights, roof penetrations, roof vents, plumbing vents, or other similar elements, and if in the opinion of the Design Review Committee, any drainage crickets are not distracting to the overall design character of the residence. On flat roofs, the flashing detail between the roof and the parapet wall must be kept horizontal, not sloped to follow the roof or cricket slope, and all flashings must be painted to match the walls.

Roofs featuring broad overhangs are encouraged to provide shade protection from harsh desert climatic conditions. However, roof overhangs and/or cantilevered elements may not exceed more than 5'-0" into the side yard setback.

A variety in rooflines is encouraged to avoid a common roofline along the street scene. Rooflines of adjoining structures should vary ridge heights and the direction of main ridgelines to enhance the roofscape of the overall neighborhood.

Predominant roof ridgelines should be designed parallel to the natural contours of the site to minimize the visual impact of roofs and any gable ends.

Creatively designed skeletal roof structures offer the opportunity to provide shelter and shade while creating roof top color through the growth of vines and other plant material.

Skylights and roof top windows are permitted and should be designed as an integral part of the roof. In addition, these elements shall be tinted bronze or gray; white or clear glass is not allowed; and all framing material shall be colored to match the adjoining roof surface.

Several types of fascias are commonly used in Desert Elegance architecture. These include concealed, flush or tight fascias, as well as broad overhanging eaves providing protection from the sun.

Fascias may be either stucco, stone or tile. Corbel elements are non-characteristic of the Desert Elegance style of architecture and are not permitted on lots in hillside conditions.

4.A.2.12 Roof Materials And Colors

4.A.2.12.a **Permitted Roof Materials:** Roof materials for each building shall consist of one of the following in either flat tiles or concrete shakes:

- Concrete Tile
- Clay Tile
- Slate

Exhibit "at" (Pages 4B.73-76) provides a full listing of all community-approved roof colors.

Standing seam metal roofs may be used, including patina copper, subject to approval by the Design Review Committee. Such roofs, however, shall have a matte finish to minimize glare.

4.A.2.12.b **Prohibited Roof Materials:**

- Barrel or "S" Tiles
- Plain Red Tiles
- Asphalt Shingles
- Fiberglass Shingles
- Reflective roof surfaces causing excessive glare
- Simulated Tile including Fiberglass or Metal

Roof colors, including flat roofs, should be selected based upon their ability to blend into the natural desert environment.

Gutters and downspouts, when used, must be concealed unless designed as a continuous architectural feature. The use of patina copper gutters and downspouts is encouraged when used as an architectural feature.

4.A.2.12.c Mechanical Equipment Screening: Mechanical equipment such as air conditioners, heaters, evaporative coolers, television and radio antennas, satellite and radar receivers and other such devices shall not be permitted on any roof. Mechanical devices such as exhaust fans, vents and pipes shall be painted to match adjacent roof surfaces.

The use of solar panels, hot water storage systems, or other similar devices shall not be visible from any street or community open space, and are subject to approval by the Design Review Committee.

All utility meters and panels must be painted to match the adjacent building color at which they are located or must be located in service yards, mechanical rooms, or within meter closets. Utility panels in excess of 400 amps require a closet, which is to be integrated into the design of the residence. Utility Panel locations must meet or exceed all requirements of the City of Henderson, Nevada Power Company and Southwest Gas Corporation.

4.A.2.13 Architectural Features And Accents

The use of architectural features and accents is encouraged to create interest on building facades. Careful placement and treatment of accent windows, for example, not only reduces the scale of the building, but also adds character to the elevations. Stairways and columns should be carefully integrated into the design of the building. Accent colors and material treatments should complement the primary building color. Extreme contrasts in style, material and/or color should be avoided.

4.A.2.13.a Entries: Front entry doors and entryways should provide a focal point to each residential unit within the building, and shall provide sun protection with overhangs or porches.

4.A.2.13.b Walkways, Balconies, Terraces and Patio Structures:

Terraces and patios provide a strong indoor/outdoor relationship to the building's residences, enhancing the integration of the structure with the surrounding natural desert environment.

The generous use of windows and doors onto terrace and patio areas strengthens the visual continuity from interior living spaces to the out of doors.

An extension of the overall roof form to cover portions of the terrace and patio areas provides effective protection from the desert sun.

Broad roof overhangs and trellises also provide shade protection for terraces, patios, and the residential dwelling units.

Walkways, terraces and patios should be constructed of that blend with the natural desert environment to the extent possible. Examples of such materials include stone, brick, and concrete colored to match the surrounding landscape. Ordinary concrete that is not colored or textured is not acceptable.

Tempered glass railings are permitted, however, their glazing must be either clear or tinted; reflective glass is not permitted.

4.A.2.13.c Windows: Special consideration should be given to solar orientation when determining window locations and details. Windows with direct sun exposure should be shielded by covered patios, wide overhangs, deep window opening recesses, shade structures, tinted glass or other similar devices, to minimize the effects of the sun.

Large picture windows are effective in capturing the spectacular views offered from the site. The use of corner glass enhances the view opportunity within the building's residences and is characteristic of the Desert Elegance style of architecture.

Metal window frames are permitted, and may be bronze or earth tone colors compatible with the surrounding desert environment. White or bright accent colors and mill finish frames are not permitted.

Window glazing may be either clear or tinted. Reflective glass is not permitted.

The use of glass block is permitted.

4.A.2.13.d Columns and Archways: The use of columns and archways add articulation to the character of the building and are encouraged where appropriate. Columns and archways should be scaled appropriately to provide a sense of strength and support, which is compatible with the architectural style of the building.

4.A.2.13.e Chimneys: Chimneys shall be designed to be in scale and proportion with the architecture of the building, and incorporate materials consistent with the detailing of the building's elevations.

A chimney mass may not exceed an overall horizontal dimension of 12', unless otherwise specifically approved by the Design Review Committee. Unconcealed metal chimney terminations are not allowed.

Use of terra cotta or fabricated sheet metal enclosures is required for metal chimneys. Masonry chimneys must provide a cap detail that is consistent with the architectural character of the residence.

Chimney heights shall conform to City of Henderson standards.

4.A.2.13.f Building Projections: All projections from a building, including but not limited to, chimney caps, vents, gutters, scuppers, downspouts, utility boxes, porches, railings, and exterior stairways shall match the color of the surface from which they project, or must be a compatible accent color, unless otherwise approved by the Design Review Committee.

4.A.2.13.g Garage Doors: The placement of garages should carefully consider the impact of the garage doors on the streetscene.

The use of auto courts in which the garage doors are oriented completely away from the street is strongly encouraged. The auto court should be screened from view from the street, adjacent properties or public spaces through the arrangement of building elements, courtyard walls, or landscape material.

Detached garages must feature the same architectural style, materials, detailing and other characteristics as the main buildings.

Garage doors shall be inset a minimum of 12" from the adjacent wall surface and should not be excessively ornamental. Roll-up garage doors are required; out-swing doors are not permitted. Wood garage doors, where permitted by the Design Review Committee, must be maintained regularly. If problems occur with wood garage doors, the HOA and/or Design Review Committee reserve the right to require such doors to be replaced.

Garages, particularly when viewed from the street, shall feature offset garage doors to minimize their impact. For example, a 3-car garage shall feature one single garage door offset from the remaining two garage doors by a minimum of 3', or separated by a minimum of 12'.

4.A.2.13.h Accessory Structures: Accessory structures include any building or structure that is totally detached from the main building. Examples of these shall include, but are not limited to the following:

- Recreation / Clubhouse Buildings
- Detached Garages
- ~~Storage Buildings~~
- Equipment Enclosures
- Shade Structures including:
 - Gazebos
 - Cabanas
 - Trellises

Any accessory structure shall be located and designed to respect the views, privacy, and other aspects of the adjacent properties. Such structures must be carefully designed to be compatible with the architecture of the main buildings of the parcel in terms of massing, scale, materials, detailing and color. The use of mature landscaping is encouraged to soften the appearance of these structures.

- 4.A.2.13.i Screen Walls:** Screen walls and fences shall be compatible with the architectural character of the building in terms of design, material and color selections. They shall be used to screen parking and service areas, and may not be used to arbitrarily delineate property lines or the Building Envelope.

In no case shall the height of a screen wall or site wall exceed 6 feet (per City of Henderson requirements) measured vertically from the lowest point at finished grade adjacent to the wall to the highest point of the wall along the exterior side of the enclosure, unless otherwise specifically approved by the Design Review Committee.

- 4.A.2.13.j Service Areas:** All above-ground trash containers, clotheslines, mechanical equipment, fuel tanks, water tanks, and other outdoor maintenance and service facilities must be completely screened from view from adjacent properties, streets, or open space areas by wall and gates at least 12" higher than the equipment. Gates, or a maze entry that provides complete screening, shall be required around all mechanical and pool equipment enclosures.

- 4.A.2.13.k Utility Equipment:** Utility equipment such as electric meters, gas meters, security equipment, HVAC units, water heaters, water softeners, swimming pool equipment, etc. shall be screened from public view in accordance with applicable utility company standards. All utility meters and panels must be painted to match the adjacent building color at which they are located or must be located in service yards, mechanical rooms, or within meter closets. Utility panels in excess of 400 amps require a closet, which is to be integrated into the design of the building. Utility Panel locations must meet or exceed all requirements of the City of Henderson, Nevada Power Company and Southwest Gas Corporation.

4.A.2.13.1 Unique Exterior Features: Unique exterior features including, but not limited to, entry arches, decorative gates, glass patterns, railings, enclosures, ramadas, gazebos, cabanas, exterior fireplaces, permanent BBQs, wet bars, or other similar features, must be designed as an integral part of the building.

Specific restrictions include:

- Circular stairs: open railings on visible exterior stairs will be reviewed on a case-by-case basis at the sole discretion of the Design Review Committee. Exterior ornamental stairs are not allowed.
- Outdoor fireplaces, fire pits or similar items shall be gas fueled only to minimize the danger of fire. Gas units are permissible; however, it is the Owner's responsibility to ensure that all outside sources of emissions must conform to, and be permitted by, applicable federal, state and municipal environmental regulations in effect at the time of submission.

4.A.2.13.m Materials: Due to climatic extremes, the use of wood as an exterior material should be carefully considered. The use of wood on exterior walls as an accent is a high-maintenance item, and is prohibited as the primary exterior material. All exposed wood beams, fascias, columns, trellises, etc., should be of glulam construction. Expression of wood trim is generally used in lintels, porches, trellises, out lookers, and rafter tails.

- Plaster finishes with a hand-troweled finish or light-sand float finish is encouraged. Spanish Lace and other heavy textures are discouraged.
- Patinaed copper gutters and hidden down spouts are permitted and encouraged.

- 4.A.2.13.n **Antennas/Satellite Dishes:** No antenna or other device such as satellite dishes, for the transmission or reception of television or radio signals or any other form of electromagnetic radiation shall be erected, used, or maintained outdoors on any Lot or Parcel, whether attached to a building or structure or otherwise, unless approved by the Design Review Committee.
- 4.A.2.13.o **Solar Application:** Passive solar application, or the orientation and design of the Residence for maximum winter sun gain will reduce the winter heating needs, and will be encouraged. Solar collectors can result in excessive glare and reflection, and can only be approved by the Design Review Committee if they are integrated into the Structures or Landscaping on a Lot or Parcel and are not Visible from Neighboring Properties.
- 4.A.2.13.p **Foundations:** All exterior wall materials must be continued down to finish grade thereby eliminating unfinished foundation walls.
- 4.A.2.13.q **Additional Construction, Revisions, Modifications and/or Exterior Changes:** Any changes to the approved plans before, during, or after the construction of an Improvement *must first be submitted to the Design Review Committee for approval.* All submittals shall be accompanied by a cover letter, letter of transmittal or a copy of the Design Review Committee's "Application for an Alternation and/or Modification to an Existing Structure or Lot" describing the revisions proposed.

NO submittals to the City of Henderson shall be made prior to complete and final approval by the Design Review Committee.

4.B.0 SITE PLANNING CRITERIA—DETACHED PRODUCTION HOMES – Planning Areas 1-Phase2, 4, 11, 17, 17A

4.B.1 INTRODUCTION & GENERAL PRINCIPLES

4.B.1.1 Architectural Theme: Desert Elegance Aesthetic

The architectural character of MacDonald Highlands draws from diverse images to create a unique concept for the community. This character is simply titled “Desert Elegance Architecture.” For production home sites this style can draw from such influences as contemporary, Spanish, French chateau, etc. Its main goal is to ensure that the colors and general overall appearance do not clash or conflict with the natural colors and character of the surrounding native desert and mountains.

Desert Elegance indicates homes that complement the natural environment of the desert.

Simple forms and the use of natural materials dominate this form of architecture. These forms provide a tasteful backdrop to the natural desert landscaping surrounding the homes and the community in general. Exterior materials such as stone and slate and earth tone colors respond to the hues and textures of the desert.

Shaded courtyards and patios provide a transition between the landscaping and the interior of the homes. Dramatic views are brought to the interior through large, shaded windows.

These concepts come together to create a community in harmony with its desert environment.

4.B.1.2 Pool & Spa Criteria and Hardscape Setbacks

Pool equipment shall not be mounted to a shared property wall, must not be visible from neighboring properties, streets, or community open space, and must be enclosed by wall with a gate or other suitable screening method.

4.B.1.3 Walls

The design and use criteria for the different types of walls to be constructed in the MacDonald Highlands community has been addressed in Section 2.10 of these Design Guidelines.

The architectural considerations of the design should be such that they comply with the community's Desert Elegance theme as well as the community concepts of openness and view preservation.

The exteriors of masonry wall sections shall be designed and constructed of natural materials that complement the colors, tones, and textures of the native desert environment.

The designs for the metal components of the view walls shall be ornate, shall convey the Desert Elegance theme, and shall remain open to preserve the views.

4.B.1.4 Service Areas & Utility Entrance Locations

Service yards are intended primarily for storage of trash, firewood, maintenance tools, etc. Minimum six-foot (6') high masonry walls are required around service yards. Pool, air-conditioning, irrigation, and other mechanical must be located underground or completely screened from view from adjacent lots, streets, or open space areas by a wall at least 12" higher than the equipment being screened within.

Electric meters and panels, gas meters, sub-panels, telephone and television panels, etc. must be out of sight when viewed from the golf course. All utility meters and panels must be painted to match the adjacent building color at which they are located or must be located in service yards, mechanical rooms, or within meter closets. Utility panels in excess of 400 amps require a closet, which is to be integrated into the design of the residence. Utility Panel locations must meet or exceed all requirements of the City of Henderson, Nevada Power Company and Southwest Gas Corporation.

The interior of enclosed service yards must not be visible from the street, golf course, or adjacent properties.

4.B.1.5 Easements

Public utility easements and drainage easements are generally located along front, side, and rear lot lines. Areas reserved for such easements are specified and identified on the recorded map for the parcel or subdivision. This area has been established as an easement area for utilities, but it is the responsibility of the owner to landscape and maintain this easement area.

Each lot is served with underground electricity, gas, TV cable, and telephone. This location of these utilities within the easement should be confirmed in the field when a topographic survey of the lot is done.

Nevada State Law requires that prior to any construction all utilities must be located and marked. It is the responsibility of the property owner and contractor to make sure all utility companies have been notified so they can provide the required utility locations. A free service is provided to accomplish the required notifications to the utility companies. This service can be contacted by calling 1-800-227-2600 "Call Before You Dig."

All utility company pull boxes, transformers, etc. have been set within the easement in a manner that will accommodate future planting and grading to diminish their visual impact. They shall be leveled and graded around to provide positive drainage.

4.B.1.6 Exterior Elevations

The design elements of a house shall be compatible and complimentary to each other, and must be sympathetic to the desert environment.

4.B.2 DESIGN CRITERIA – DETACHED PRODUCTION HOMES [Planning Areas 1-Phase 2, 4, 11, 17, 17A]

Introduction

The goal for developing the architectural theme of MacDonald Highlands is to project a harmonious image and a distinctive identity. This should be achieved not by dictating a particular style but encourage a blending of styles emphasizing simple, strong masses and forms.

The purpose of these Architectural Standards is to provide guidance for the Lot Owner and architect. The maintenance of high architectural standards protects and enhances real estate values at MacDonald Highlands. The restriction of unsightly construction also helps to ensure that the image of a prestigious community is maintained. All proposed construction shall comply with the following general criteria:

- Is the residence compatible with a prestigious, high-quality image?
- Will the proposed residence maintain the character of the community?
- Does the residence seem appropriate to the concept of the community?

MacDonald Highlands is planned as one of the premier luxury communities in the United States. The community's incomparable setting, featuring majestic and rugged topography with expansive golf course amenities, and proximity to one of the country's most unique destination resorts, require an unparalleled unity and excellence in design, architecture, and landscape.

MacDonald Highlands has created a uniquely strong architectural image. The Design Review Committee's purpose is to ensure that the entire project is developed as originally envisioned. The Design Guidelines are intended to supplement existing City and County ordinances. The objectives of the Design Guidelines are to encourage and foster careful design so there is harmony between the homes, their sites, and the golf course, desert environment, and overall image. Emphasis is placed on utilizing the Owner's property to its fullest potential within the Design Guidelines. To accomplish these objectives, the following considerations must be understood and accepted:

- The design, review, and processing of each residence will be subject to direction and approval of the Design Review Committee. The review and approval process and Design Guidelines will ensure continuing high quality and compatibility of design within the custom lots and overall framework.
- The Design Review Committee and Design Guidelines are intended to enforce reasonable controls concerning various aesthetic considerations for MacDonald Highlands. These controls are not meant to duplicate or supersede the functions normally provided by public agencies, but rather to coordinate and direct the design and construction of the custom lots with different architects, landscape architects, engineers, contractors, and their owners, so as to achieve a pattern of quality and outstanding character.

The forms and materials should provide a response to the need to provide shelter from the sun with large overhangs to shade windows, mixed colors for reflection and blending, and covered porches to provide shaded outdoor areas.

It is the intent of these Design Guidelines to establish a consistent architectural theme for MacDonald Highlands, while allowing for flexibility of design expression.

To be part of the planned community of MacDonald Highlands, it is necessary for the residence to conform to certain general planning standards, which are as follows:

- All production homes in MacDonald Highlands must be designed by professionals licensed in the State of Nevada.
- All residences must be well-constructed of quality materials. Additions must be consistent in design and quality with the original structure. Two or more lots can be assembled to provide land necessary for larger residences, tennis courts, guest quarters, or maid's quarters.

4.B.3 SITE PLANNING CRITERIA – DETACHED PRODUCTION HOMES [Planning Areas 4 1-Phase2, 4, 11, 17, 17A]

Introduction

The natural topography, vegetation and setting of MacDonald Highlands create a unique environment, which requires careful attention throughout the site design and development process. The integrated design of site and residence is crucial to ensure that the dwelling blends harmoniously into the surrounding desert landscape. The design must fully analyze the unique physical characteristics of the lot, including topography, slope, view, drainage, vegetation, and access.

The desert landscape is a fragile environment, and may take many years to naturally recover from the impacts of disturbances related to site development. In order to minimize these impacts, MacDonald Highlands along with the City of Henderson, have developed the criteria within this Supplemental Design Guidelines manual to protect the natural desert character of the community.

4.B.3.1 Building Envelope

The Building Envelope shall be defined as the minimum front, rear, side and corner setbacks as set forth in Section 19.3.4.1 of the City of Henderson Development Code.

4.B.3.2 Building Orientation

The production areas within MacDonald Highlands have been designed to provide a sense of exclusivity to each of the neighborhoods. The Design Review Committee will consider each parcel independently, and will give extensive consideration to view corridors, impacts on adjacent homes, drainage patterns, impacts to existing site conditions, and driveway access.

4.B.3.2.a View Orientation: The hillside character of MacDonald Highlands provides spectacular view opportunities for most of the lots throughout the community. The orientation of the residence's major rooms, patios and terraces should be designed to take advantage of these dramatic views. The use of large picture windows and corner glass are especially effective in capturing the views offered by the site, and are characteristic of the Desert Elegance style of architecture.

SITE PLANNING CRITERIA – PRODUCTION HOMES
MINIMUM SETBACKS

Planning Areas:	ZONE	FRONT	SIDE		REAR
			Interior Side	Street Side	
11	RS-6	20' to garage 14' to non-garage	5'	10'	15'
4	RS-4	25'	7.5'	15'	30'
17	RS-6	20' to garage 14' to non-garage	5'	10'	15'
1-Phase2	RS-6	20' to garage 14' to non-garage	5'	10'	15'
17A	RS-6	20'	5'	10'	15'

With the golf course orientation of MacDonald Highlands, there is an inherent risk that golf balls and the play of golf may impact lots or residences with golf course frontage. The Design Review Committee strongly recommends that, during the planning of site improvements on your lot, careful consideration be given to the possibility of errant golf balls, particularly regarding the orientation of windows or other breakable surfaces of the dwelling. Netting, screens, excessive landscaping, fences or large blank walls will not be allowed. Evaluation of the proper siting, orientation, massing and setbacks should provide for maximum golf or view orientation with minimal adverse impact from the play of golf. Design consideration should also be given to the noise generated by golfers, golf carts and maintenance vehicles.

4.B.3.2.b Relationship To Adjacent Lots & The Overall Community: Residential structures should be designed to blend into the overall character of the desert environment as much as possible, minimizing any negative visual impact from surrounding areas. The design of individual homes should carefully consider the scale, proportion, and massing of building elements to ensure the resulting structure is compatible with the overall philosophy of MacDonald Highlands.

It is the intent of these guidelines to ensure that not only are the architectural designs consistent with community standards but that each new home compliments and enhances those homes that already exist.

4.B.3.3 Driveway And Parking Criteria

4.B.3.3.a Driveway Location: Driveways should be located in a manner that minimizes their visual impact on significant natural features of the lot, such as vegetation, washes or drainage ways. Driveways should also be located such that there is no interference with drainage in the street right of way.

4.B.3.3.b Driveway Materials: All driveways are required to be patterned concrete, stone, brick, 'Bomanite', or other similar textured paving materials. The color of driveway materials must be compatible with the guidelines outlined in Section 4.B.4.5. Ordinary concrete without color or textural embellishment will not be allowed.

4.B.3.3.c Parking Spaces Required: Each residence must provide at least four off-street parking spaces. A minimum of two of these spaces must be in an enclosed garage, either attached or detached from the main residence. Carports are not permitted, except where enclosed on three sides and made an integral part of the structure. On-street parking is limited to visitors and guests only. Due to City of Henderson Fire Code,

on-street parking is limited to one side of the street only. The approved street parking for visitors and guests will be limited to the southside and the eastside of the street only (*per MacDonald Highlands Master Association Rules and Regulations adopted July 10, 2002*). Views of guest parking areas from adjacent lots, streets, or public spaces must be minimized by depressing them, using screen walls, or landscaping or a combination of these. Screen walls will be a maximum 6'-high (per City of Henderson requirements). No exterior storage of recreational vehicles or boats will be permitted.

- 4.B.3.3.d Repair of Damages:** It shall be the lot owner's responsibility to repair existing streets, curbs, sidewalks, utilities, neighboring lots, or other existing elements, which may be damaged as a result of construction activity on the owner's lot.

4.B.3.4 Site Amenity Standards

- 4.B.3.4.a Accessory Structures:** All accessory structures, such as gazebos or trellis structures, are to be reviewed and approved by the Design Review Committee prior to construction.

- 4.B.3.4.b Swimming Pools:** Swimming pools should be designed to visually connect with the residence through the use of walls or courtyards, and must be screened from direct view of the street, natural areas, or neighboring properties. They must be constructed according to the City of Henderson Regulations and other applicable regulations, including required fence and enclosure heights. Doors and gates leading to swimming pools and spas must meet the City of Henderson safety and closure regulations including doors that open directly from the residence to any pool or spa area.

Pool backwash or pool draining is not allowed to be disposed of in the sanitary sewer system, nor due to environmental concerns, is it allowed to be disposed of

into a wash or other natural drainage area. It is recommended that a dry well be constructed to allow for disposing of pools backwash and draining. Any applicable City of Henderson regulations governing disposal of pool water must be followed.

4.B.3.4.c Exterior Recreational Or Play Equipment: All exterior recreational or play equipment such as swing sets, slides, play structures, jungle gyms, pool slides and other similar equipment must meet the intent and requirements of all sections of the Design Guidelines, including color. This type of equipment or structures should be located in the least visible portions of the lot. All exterior recreational or play equipment requires specific approval of the Design Review Committee prior to installation.

4.B.3.4.d Basketball Hoops: Basketball hoops and backboards may be installed at any residence subject to prior approval by the Design Review Committee, and may be subject to stipulations imposed by the Design Review Committee based on specific review of the request.

4.B.3.4.e Address Identification: In an effort to provide consistency within MacDonald Highlands while conforming to its design philosophy, two distinct address identification devices have been selected for the community. These devices were chosen because they offer numerous options for glass and designer finishes, allowing flexibility to the Lot Owner to best match the design, materials and colors of his/her residence. The specified address identification devices are as follows:

Model#	Width	Height	Ext.
SPJ43-02A	11"	5 1/2"	2 1/4"
SPJ43-02B	14 1/2"	5 1/2"	2 1/4"
SPJ43-02C	18"	5 1/2"	2 1/4"

Shown: Aged Brass / Honey Iridescent
Model: SPJ43-02A
 (3) # Address Light

Shown: Rusty / Frosted Seedy
Model: SPJ43-02B
 (4) # Address Light

Model: SPJ43-02C (Not Shown)
 (5) # Address Light

All Above:
Mounting: Flush Mount
Socket: (2) Single Contact Bayonet
Electrical: 12V
Lamp: (2) 13W Max.

Recessed & Custom Sizes Available!

SPJ Lighting, Inc. /Address Light Model #SPJ43-02
 available through Nevada Sales Agency, Las Vegas
 (702) 270-4181 Phone (702) 270-4196 FAX

Individual address identification devices for each approved residence shall be installed by the homebuilder and such devices should be compatible in design, materials and colors with the residence.

No additional signage detached from the residence will be permitted.

4.B.3.4.f Exterior Lighting: The goal of MacDonald Highlands, to preserve the visual character of the desert environment, extends to nighttime as well as daytime conditions. In order to preserve the dramatic views of the city lights and the night sky, which tend to be obscured by excessive local lighting, the following guidelines have been established for residential site lighting. Site lighting is defined as lighting mounted to the any exterior surface of the residence, ground, trees, site walls, fences or any other site feature for the purpose of providing security, decorative accent or functional lighting to outdoor spaces.

Site lighting located on the side of the residence facing the golf course is strongly discouraged. "Footlights" that are directed down and other down light fixtures that are mounted close to the ground with minimal light output are best suited for this side of the residence.

- Subtle, low-level lighting of landscape areas is encouraged. Landscape lighting, however, shall not intrude or produce a glare onto adjacent lots, lots across the street, or onto any public space. Landscape lighting must be directed downward onto vegetation or prominent site features, and may not be used to light walls or building elements. All lighting must be directed toward the interior of the lot upon which it is located.
- Building mounted lighting must be directed downward away from adjacent lots, streets, and community open spaces, and may not be used to light walls or building elements for decorative purposes.

- All exterior lighting must provide for significant shielding to ensure that light sources and lamps are not visible from neighboring property; no bare lamps will be permitted.
- Recessed and soffit lighting in *entries, above garage door bays, and on patios and covered balconies* shall have a maximum wattage of 75 watts and the lamp must be recessed a minimum of 3" into the ceiling. Recessed lamps must also have a minimum 5' separation between fixtures.
- Lights in *exterior soffits and eaves* are not allowed, as they are not appropriate in the development of hillsides.
- Only incandescent lamps with a maximum wattage of 75 watts will be allowed for exterior lighting unless specific approval is received from the Design Review Committee. Low voltage lighting is recommended, since these fixtures are typically small and can be easily concealed within the vegetation. Colored lights will not be allowed for exterior lighting.
- Tree lights are allowed, however, no chasing, twinkling or blinking lights are permitted.
- Lights on motion detectors will only be allowed to operate stay lit for a maximum of 20 continuous minutes. Security lights of any type or locations must still meet the requirement of shielding the light sources, and the light sources may not be visible from neighboring property. Special care must be taken to avoid setting off the detector by the motion of vegetation and the movement of wildlife. These lights will not be allowed to operate for the purpose of general illumination.

- If problems occur with any exterior lighting, the HOA and/or Design Review Committee reserve the right to require such fixtures be disconnected.

4.B.3.4.g Exterior Holiday Decorations:

The intent of this section is to ensure that exterior holiday decorations are compatible with the overall community image of MacDonald Highlands. They are not meant to discourage decorating during holiday periods. Holiday decorations should be tastefully subtle, and should not have a commercial appearance nor be "over done" in terms of brightness, size, or visibility from public spaces. The Design Review Committee reserves the right to prohibit any holiday decorations it deems inappropriate with the community image of MacDonald Highlands.

Decorations shall not be allowed to be mounted on roofs or located outside of the site walls.

No exposed spotlights will be allowed. Luminaries are allowed along driveways and patios, but not on roofs or parapets. Paper luminaries with candles are not allowed due to the potential danger of fire. Care must be taken that luminaries do not blow away or litter adjacent properties.

Christmas decorations are allowed to be displayed one month prior to and one month after the actual holiday. Decorations for other holidays may be installed no more than two weeks prior to the holiday and must be removed within one week after the holiday.

4.B.3.5 Design Criteria

4.B.3.5.a Water (Public Works): Water System Design: All water systems shall be designed in accordance with the Uniform Design and Construction Standards for Water Distribution Systems, Clark County and the Uniform Standard Specifications for Public Works Construction, Clark County area.

- **Water (Fire Department):** Water System Flow: The water mains and the distribution system shall be designed to meet all applicable City of Henderson Fire department requirements.
- **Building Fire Sprinkler Systems:** Buildings may, or may not, require a fire sprinkler system, at the sole discretion of the City of Henderson Fire Department. Neither The Foothills Partners nor MacDonald Highlands Realty shall be held liable for any revisions to fire protection requirements that the City of Henderson Fire Department may make.
- **Water Main Sizes:** Residential water main sizes shall be designed in accordance with City of Henderson Public Works standards.
- **Fire Hydrant Branch Lines:** Fire hydrant branch lines shall be set at right angles to street mains. The hydrant shall be set at the end of the branch line and shall face the branch. No horizontal or vertical bends or reducers shall be used in installing fire hydrant branch lines unless specifically approved by the City of Henderson. Under no circumstances shall any size or manner of tap be made on a fire hydrant branch line.

- **Fire Hydrant Location and Distribution:** The number and spacing of fire hydrants shall meet the approval of the Fire Prevention Division. Fire hydrants shall be located adjacent to and accessible from fire apparatus access roads. Fire hydrants shall be located along fire apparatus roads as follows:
 - Spacing of fire hydrants shall normally start by placing fire hydrants at all intersections or;
 - In all residential areas, fire hydrants shall not be spaced greater than 750 feet apart, or;
 - The maximum distance from a Group R, Division 3 Occupancy to a fire hydrant shall not exceed 500 feet, as measured from an approved point on a street or road frontage to a fire hydrant.
- **Wastewater Collection and Treatment:** Wastewater collection systems shall be designed in accordance with the Design and Construction Standards for Wastewater Collection Systems, Clark County, 1991 and the Uniform Standard Specifications for Public Works Construction, Clark County area. Septic systems shall not be permitted.
- **Drainage Design:** Drainage facilities shall be designed to maintain the natural run-off characteristics. Drainage facilities shall be designed in accordance with the Clark County Regional Flood Control District Hydrologic Criteria and Drainage Design manual. Private drainage facilities, cross lot drainage easements or rear lot drainage easements shall be privately maintained.

- **Roadways:** Within the hillside neighborhoods, all roadways whether public or private, shall be designed according to the standards described in Table 3.38, as well as AASHTO requirements. The standards are also intended to supplement the Public Works Department Plan Review Guidelines. Roadways should be located such that impacts to the natural environment are avoided.

Roadways should follow the topography of the area to minimize grading cuts and fills. Curvilinear horizontal alignments and gently rolling profiles consistent with the natural topography will minimize unnecessary site disturbance. Significant features such as rock outcroppings should be avoided.

- **Homeowners Association:** Each hillside development plan that provides for private streets or improvements, common areas or natural areas shall establish and maintain a Homeowners Association. The association shall be responsible for the maintenance and upkeep of all private streets and improvements as well as all common areas.

Natural areas may be designated as a deed-restricted portion of a privately owned lot, or as a separate parcel. Such parcel may be under the ownership of a homeowner's association or deeded to any organization, which accepts responsibility for the perpetual preservation and maintenance of the natural area, subject to approval and acceptance by the City of Henderson. To protect the natural areas, covenants that run with the land shall be recorded in favor of the City of Henderson and of all owners with record interest in the natural area.

4.B.3.5.b Production Lot Criteria

- No change in natural or existing drainage patterns for surface water shall be made on any lot that could adversely affect another lot.
- Retaining walls and other walls not directly supporting a building structure, except screen walls, shall typically not exceed 8 feet in height, measured vertically from the lowest finished grade adjacent to the wall along the exterior side of the enclosure. Where additional height is necessary, and subject to approval by the Design Review Committee, retaining walls must be terraced with a minimum separation of 2 feet between walls and an overall height not to exceed 16 feet. Subject to approval by the Design Review Committee, other acceptable methods for minimizing the impact of retaining walls greater than 8 feet in height include: landscaping with mature indigenous trees or large shrubs; and/or using a different texture and/or material such as stone for a portion of the wall treated to blend with the natural terrain.
- *Screen walls*, walls not supporting a building structure or retaining earth, may not exceed 6-feet in height (per City of Henderson requirements) measured from finish grade along the exterior side of the enclosure in the manner described above for retaining walls.
- Stone used as a landscape material shall be 1" or less in size, and shall match the color of the existing native stone on the homesite. Rounded pea gravel may not be used as a landscape or driveway material.
- Native stone indigenous to the site is allowed for rip rap or other landscape treatments, as well as river rock stained to match the native stone.

SITE PLANNING CRITERIA –PRODUCTION HOMES ROADWAY STANDARDS

For roadways serving greater than 100 residential units, the design criteria shall be reviewed on a case by case basis with the City of Henderson Public Works Department.

For roadways serving 100 or fewer units, the following standards shall apply:

Right of Way:	42 ft (no parking or parking one side) 45 ft (parking on both sides)
Travel Lanes:	2
Face of Curb Dimension:	24 feet (no on-street parking) 28 feet (parking on one side) 36 feet (parking on both sides)
Curbing	Curbing shall be required. (Curb type shall be as approved by the City Engineer)
Design Speed:	20 miles per hour
Stopping Site Distance:	125 feet
Site Distance (intersections):	200 feet
Minimum Center Line Radius (w/o Superelevation):	180 feet
Minimum Center Line Radius (w/2% Superelevation):	140 feet
Minimum Grade:	0.4%
Maximum Grade:	15%, except that a fire apparatus road within 50 feet of a structure, the grade shall not exceed 8%. In lieu of providing an 8% roadway grade within 50 feet of a structure, the structure shall have a full building fire sprinkler system per City of Henderson Fire Department requirements.
Maximum Grade Length:	7 - 9%: 1400 feet 9 - 12%: 700 feet 12 - 15%: 350 feet
Minimum Curve Length:	100 feet
Vertical Clearance:	13.6 feet
Sidewalks:	Minimum lot sizes less than 20,000 sq. ft.: 4' walk; one-side only Minimum lot sizes greater than 20,000 sq. ft.: No sidewalk required
Cul-de-sacs:	Radius (45 foot measured to the face of curb)
Maximum Units Served:	25.
Vertical Curves	Required if grade difference exceeds 1%.
Roadway Aprons:	2% maximum slope measured 4 feet from the back of curb on both sides of the street.
Right of Way Slope:	3 feet horizontal for 1 foot vertical behind the roadway apron and within the right of way.
Cross Slopes:	4%
Street Lighting:	Intersections and other locations for public safety as required by the City of Henderson Public Works.
Intersection Spacing:	200 feet, measured center line to center line.

4.B.3.5.c Lot Grading and Drainage: Surface drainage shall not flow to adjacent lots or open spaces except as established by existing natural drainage patterns, or cause a condition that could lead to off-site soil erosion onto such areas.

Culverts, when used, should be concrete with exposed surfaces treated with PERMEON to match the adjacent natural landscape of the desert. In addition, end walls or other terminal structures should be similarly treated with PERMEON.

Where grading is unavoidable, careful consideration should be given to the impact to the natural appearance of the surrounding landscape. The following measures should be used to minimize negative visual effects of site grading, including:

- Exposed escarpments shall not exceed 2:1 in slope. In order to provide a natural appearance to such escarpments, the slopes should be varied (2:1, 3:1, 4:1 & 5:1) providing an undulating appearance.
- Cut and Fill conditions in excess of 2:1 slope shall use rip rap or other rock-type erosion control methods. Rip rap or other erosion control features shall be stained to match the surrounding conditions of the natural desert environment.
- Smooth transitions between escarpments and natural topography are required at the top and toe of such slopes by rounding the transition areas.
- Disturbed areas should be reshaped to duplicate the original natural slope to the extent feasible.

- Disturbed areas should incorporate erosion control measures such as landscaping, rip rap, or other similar techniques, as approved by the Design Review Committee.
- The grading of an individual homesite should respect the existing natural drainage conditions of the lot. Where feasible, existing drainage channels should be maintained in their natural condition.
- For Lots where a dedicated drainage easement(s) exists within the property boundaries, no permanent structures or walls are permitted within the drainage easement and landscape material is restricted to grass and groundcover plants (i.e., trees are not permitted). In addition, openings such as decorative block or iron will be required to ensure proper drainage flows.

4.B.4 ARCHITECTURAL DESIGN CRITERIA – DETACHED PRODUCTION HOMES [Planning Areas 1, 4, 11, 17 and 17A]

4.B.4.1 ARCHITECTURAL CHARACTER

The primary goal for the design of residences within MacDonald Highlands is to create a homesite that integrates the architecture of the dwelling with the natural character of the surrounding desert landscape. The resulting architectural style is best described as "Desert Elegance". For production home sites this style can draw from such influences as Contemporary, Spanish, French Chateau, etc. Its main goal is to ensure that the colors and general overall appearance do not clash or conflict with the natural colors and character of the surrounding native desert and mountains.

This integration of architecture to the site is further enhanced through the extensive use of terraces and courtyards providing a strong indoor/outdoor relationship to the residence. Finally, the proper use of color is crucial for the successful design of the house. Building colors have been selected for their ability to blend naturally into the desert environment, such as "earthy" tones of buff, sand, beige, gray and other hues of the areas natural landscape. Bold color schemes featuring crisp whites, pastels, or bright colors are not permitted.

The purpose of the Architectural Design Criteria is to ensure that the architectural character of the Production Homes is compatible with that of the overall character envisioned for MacDonald Highlands, while encouraging unique, innovative and creative design solutions to individual residences. Individual consideration will be given to the aesthetic and physical relationships of the residence to the site and adjacent dwellings.

4.B.4.2 Floor Areas

Architectural Character – Production Lot Criteria
Floor Areas

	PLANNING AREA	MINIMUM LOT SIZE	RESIDENCE SQ. FT. RANGE	MAX. F.A.R.*
Executive Estates	4, 17	10,000	N/A	N/A
Standard Estates	1-Phase2, 11, 17A	6,000	N/A	N/A

4.B.4.3 Architectural Components

BUILDING FACADES	ROOFS	ARCHITECTURAL FEATURES / ACCENTS
FORM / MASS COURTS / PORCHES SHADOW OPENINGS MATERIALS / TEXTURE	ROOF PITCH OVERHANGS MATERIALS	ACCENT WINDOWS / DOORS DECKS / PATIOS FENCES / WALLS ACCENT COLOR / TREATMENTS

The architecture of a detached production home can be broken down into three major components, including 1) Building Facades, 2) Roofs, and 3) Architectural Features & Accents. The proper design treatment of these three components will result in a visually pleasing residence and neighborhood environment throughout MacDonald Highlands. The following is a general description of how each of these components should be addressed relating to the Desert Elegance architectural style.

4.B.4.4 Building Facades

The three dimensional success of a building and its site elements is a result of the careful treatment of building mass, proportion and scale, articulated by a variation in texture, materials, and color treatment. In general, large building masses should be avoided because of the resulting scale that would be out of balance in achieving a desirable relationship to the desert environment. Structures that require greater amounts of space, should have vertical and horizontal offsets to break up the building mass and create a more desirable scale and visual interest to the dwelling. The interplay of shade and shadow, along with texture and openings in large building surfaces provides interest, balance, and human scale to the residence. In addition, the use of terraces, porches and balconies, window and entry treatments further emphasize building articulation. Together, each of these elements enable the creation of a residence, which will blend harmoniously into the natural desert environment.

4.B.4.4.a Building Massing and Scale:

MacDonald Highlands encourages single-story production structures to maintain lower roof lines, *generally* a 20 foot height measured as the vertical distance in feet between finish floor elevation and the highest roof peak, although certain production single-story home models may exceed 20 feet in height, dependent upon architectural style and design.

Those Residences that obtain an approved 2-story element may not exceed a height of 35 feet measured as the vertical distance in feet between finish floor elevation to the highest roof peak.

4.B.4.4.b Massing: The proper massing of Desert Elegance architecture will reduce the visual scale of a large structure, and create building texture, which helps blend the residence with the surrounding natural environment.

Unless otherwise specifically approved by the Design Review Committee, homes less than 5,000 square feet shall be composed of at least three visual building masses as viewed from the front and rear, while homes larger than 5,000 square feet, excluding garages, shall feature at least four visual masses as viewed from any elevation.

4.B.4.4.c Articulation: The horizontal character of Desert Elegance architecture is enhanced by the integral design of outdoor living spaces such as terraces and patios as a transition between the residence and the natural landscape environment. Extended roof forms and broad overhangs are often used to provide cover for these spaces, protecting them from the harsh climatic conditions of the desert.

The use of front entry courtyards is encouraged as a transition from the public space of the street to the private dwelling. Building wings as well as landscape walls (or a combination of these) are effective in creating this entry courtyard space.

4.B.4.5 Exterior Materials

Exterior surfaces shall generally be of natural material that blend with and are compatible with the natural landscape. Materials should be selected based on their ability to withstand the extreme climatic conditions of the desert. Exterior building walls shall consist of at least one, but not more than three of the following:

- Stone such as the following:
 - Granite (Thermal or Honed Finish)
 - Arizona Sandstone (Thermal or Honed Finish)
 - Slate (Cleft Finish)
- Split-face CMU block of earth tone colors compatible with the surrounding desert environment
- Brick (clay)
- Stucco or plaster with a light to medium texture, such as dash, smooth, sand or lace. (Heavy textures such as swirl or heavy trowel are prohibited.)
- Glass / Glass Block

Large expanses of painted surfaces, particularly wood, will not weather well in desert conditions and will not be approved.

All surface treatments or materials shall be designed to appear as an integral part of the design, and not merely applied. All materials shall wrap columns, porches, or balconies in their entirety.

Material changes (where proposed) should occur at inside corners. Siding materials shall be continuous to within 6" of finished grade. Exposed footings are not permitted.

Highly reflective finishes shall not be used on any exterior surfaces.

4.B.4.6 Color Overview

Nestled in the McCullough Mountain range, the community of MacDonald Highlands has a unique natural setting. Building colors and materials must be in muted desert shades in order to blend the residences harmoniously into the surrounding desert landscape. To help builders and architects achieve this goal, MacDonald Highlands has developed a color program that:

- Identifies appropriate colors.
- Outlines criteria for color selection.
- Gives guidelines for color implementation.

All builders and architects shall utilize this color program in the planning and execution of exterior finishes.

4.B.4.7 Color Program

Roof, field and masonry color palettes have been identified for use at MacDonald Highlands. Builders are required to make their selections from these palettes, however, additional colors and color combinations may be considered by the Design Review Committee provided the alternate color(s) complies with community-specified light reflectance value ranges, and is consistent with and compliments the natural surroundings. Final approval or disapproval of an alternate paint color(s) and/or color combination(s) will be judged at the sole discretion of the Design Review Committee.

The community-approved palettes are defined by the following criteria:

- Roof colors that are flashed or modeled and have a medium light reflectance value (LRV).
- Field colors that are muted shades with a light reflectance value (LRV) between 75% and 15%.
- Masonry materials that are natural in form and compatible in color with the desert environment.

The topography of the development suggests the need for two levels of field color usage. The Lower Hillside areas in which all detached production homes shall be constructed (PA1-Ph2, PA4, PA11, PA17, PA17A) have full use of all colors in the defined Field Color Palette.

The Lower Hillside areas have a field color palette that is defined by colors with a LRV between 75% and 15%. This is available for secondary as well as primary field colors. Exhibit “at” provides a full listing of all approved roof, field and masonry (faux) materials.

Remaining colors to be identified for a residential color scheme, fascia, trim, garage door & accent must also be in muted shades that blend appropriately with the desert environment. The builder or architect, from their own source, may select these colors as long as they maintain a LRV of 70% or less and will be reviewed by the Design Review Committee.

4.B.4.8 Color Palette Design Kit

A “Color Palette Design Kit” (Design Kit) has been created for use by the builders and architects in MacDonald Highlands to assist them with their selections from the defined roof, field and masonry palettes. Each Kit contains a color fan deck of the Field Color Palette as well as a listing of the approved roof and masonry colors. Within the Field Color Palette, the Upper Hillside primary field color options will be identified by shortened paint chips.

Listed on the front of each chip in the fan deck is the manufacturer's reference number, name and light reflectance value (LRV).

FRAZEE PAINT was selected for use in the Design Kit, *however, manufacturer crossovers are acceptable so long as the corresponding Frazee number, name and LRV are noted when submitting a color package or scheme to the Design Review Committee for review.*

4.B.4.9 Production Color Requirements

Production home color palettes shall utilize the following guidelines:

4.B.4.9.a Roof Colors: Roof colors shall be selected from the approved palette. *Manufacturer crossovers are acceptable only if they maintain the roof color criteria.*

4.B.4.9.b Building Colors: A color palette shall have a minimum of three different colors not counting the roof. One of those colors may be a masonry material.

Hardscape colors and/or materials do not classify as one of the four required colors, as these accents are not applied to the actual residence.

4.B.4.9.c Color Plotting: In an effort to offer the most balanced blend of materials and colors as possible, adjacent and facing residences shall not have the same front or rear elevation and shall not have the same color scheme. However, opposite hand footprints with variations in elevation design elements and a different color scheme will be permitted.

4.B.4.10 Color Submittals

Submittals for Builder color packages and Production Home color palettes to the Design Review Committee must contain the following information:

A color and material sample board showing the selected building colors, roof and masonry material. *The Frazee paint reference number, name and LRV must be identified on the board. **Paint crossovers must list the Frazee color as well.***

When multiple field colors are used, exterior elevations showing the color application strategy shall be submitted (i.e., Color Blocking Exhibits). See Exhibit “au” for submittal example.

Manufacturer cut sheets, photographs or samples of any materials, which require further or more detailed explanation such as: lighting, special ornamentation elements, custom gates, etc.

ARCHITECTURAL COLOR PALETTE

FIELD COLORS

Lower Hillside – Field Color Palette

8253M	8254M	8255D	
8283W	8284D	8285A	
8303W	8304M	8305D	
8664M	8665D		
8683W	8684M	8685D	
8693M	8694M	8695D	
8703M	8704D	8705D	
8713W	8714M	8715D	
8723M	8724M	8725A	
8732W	8733M	8734M	8735D
8742W	8743M	8744D	8745A
8753M	8754D	8755A	
8773M	8774M		
8812W	8813W	8814M	
8822W	8823W	8824M	

Upper Hillside – Primary Field Color Palette

8253M	8254M	
8283W	8284D	
8303W	8304M	
8683W	8684M	
8693M	8694M	
8713W	8714M	
8723M	8724M	
8732W	8733M	8734M
8742W	8743M	8744D
8752W	8753M	8754D
8762W	8763M	
8773M		
8812W	8813W	
8822W	8823W	

Exhibit "at"

ROOF COLORS

MONIERLIFETILE

Standard Shake:	1SRCB3233R	Brown Blend Brushed (formerly #501)
	1SRCB1430R	Charcoal Blend Brushed (formerly #503)
	1SRCB1132R	Charcoal Brown Blend Brushed (formerly #505)
Standard Slate:	1LSCS3233R	Brown Blend (formerly #1271)
	1LSCS1430R	Charcoal Blend Brushed (formerly #1273)
	1LSCS1132R	Charcoal Brown Blend Brushed (formerly #1275)
	1LSCS4598R	Forest Green (formerly #1248)
	1LSCS0026R	Sandstorm (formerly #1280)
M2000Shake / Vignette:	1SKCB3960	Cattails
	1SKCB3940	Cliffside
	1SKCB3934	Saddle
	1SKCB5937	Silver Rock
	1SKCB5932	Silver Smoke
	1SKCB3958	Smokey
/ Collage:	1SKCB3949	Mahogany
	1SKCB7951	Mulberry
	1SKCB3942	Raffia
M2000Slate/ Vignette:	1STCS3960	Cattails
	1STCS3940	Cliffside
	1STCS7933	Flashburn
	1STCS6938	New Bronze
	1STCS3934	Saddle
	1STCS4930	Silhouette
	1STCS5937	Silver Rock
	1STCS7980	Slate Plum
	1STCS3958	Smokey
/ Collage:	1STCS0959	Turtle Dove
	1STCS7954	Camelot
	1STCS3957	Cobblestone
	1STCS3947	Heather
	1STCS3949	Mahogany
	1STCS7951	Mulberry
	1STCS3942	Raffia
	1STCS5969	Wolf Grey
/ Tapestry:	1STCS3963	Camouflage
	1STCS4976	Impressionist
	1STCS3962	Tiger Eye

Exhibit "at"
(continued)

MONIERLIFETILE (continued)

M2000Split Shake		
/ Vignette:	1SECB3934	Saddle
/ Collage:	1SECB3949	Mahogany
	1SECB3946	New Bark
/ Tapestry:	1SEBC3963	Camouflage
T2000 – Traditions:	1TRCD3083	Hearthside
	1TRCD3079	Manorhouse
	1TRCD3085	Plantation
	1TRCD3080	Riverpebble

PIONEER

Standard Slate:	SL 550	Ironwood Blend
	SL 547	Sandalwood Blend
	SL 544	Cocoamo Grey
	SL 543	Camino Blend
	SL 541	Santa Clara Blend
	SL 540	Solano Blend
	SL 513	La Jolla Blend
	SL 433	Kona Blend
	SL 503	Cobblestone Green
	SL 471	Birchwood Blend
	SL 504	Boroughwood
Weathered Shake:	WS 550	Weathered Ironwood Blend
	WS 544	Weathered Cocoamo Grey
	WS 543	Weathered Camino Blend
	WS 541	Weathered Santa Clara Blend
	WS 540	Weathered Solano Blend
	WS 513	Weathered La Jolla Blend
	WS 411	Chestnut Brown
	WS 471	Birchwood Blend
	WS 546	Oakwood Blend
	WS 504	Boroughwood

DISCONTINUED MONIERLIFETILE

(Discontinued by MonierLifetile January 2000)

General Line:	1276	3188	3206		
Vignette:	7973				
Collage:	3935	3961	7943	7952	7977
Tapestry:	7971				

Exhibit "at"
(continued)

MASONRY COLORSEldorado Stone:

Hillstone: Molano, Lucero

Fieldledge: Meseta, Veneto

Shadow Rock: Teton, Bronze, Mountain Blend

Rustic Ledge: Sequoia, Prairie, Sawtooth, Cascade (w/wo rubble)

Mountain Ledge: Smokey, China, Buckskin, Warm Springs, Copper

Stacked Stone: Mountain Blend, Desert Shadows, Slate Gray, Castaway

Weather Edge: Wisconsin, Calistoga

Cultured Stone:

Country Ledge: Honey, Chardonnay, Caramel, Aspen

Southern Ledge: Chardonnay, Rustic, Fog, Bucks County

Weather Edge Ledge: Fox Valley, Wisconsin, Silverado

Pro-Fit Ledge: Mojave, Autumn, Shale

Caroline Ledge: Vintage Sand, Pewter Gray, Onyx Brown,
Silver Sand

Drystack Ledge: Caramel, Chardonnay, Mist, Cedar, Suede

Southern Ledge & Dressed Fieldstone: Fog & Aspen, Bucks
County, Rustic & Brandywine, Chardonnay

Country Ledge & Dressed Fieldstone: Caramel & Brandywine,
Chardonnay & Chardonnay, Honey & Brandywine, Aspen &
Aspen

DISCONTINUED MASONRY COLORS:

Eldorado Stone: "La Jolla" Coastal Ledge, "Santa Cruz" Coastal Ledge

Eldorado Stone: "Oakwood" Stacked Stone

Eldorado Stone: "Napa Valley" Weather Edge

Cultured Stone: "Fawn" Southern Ledge

Exhibit "at"
(continued)

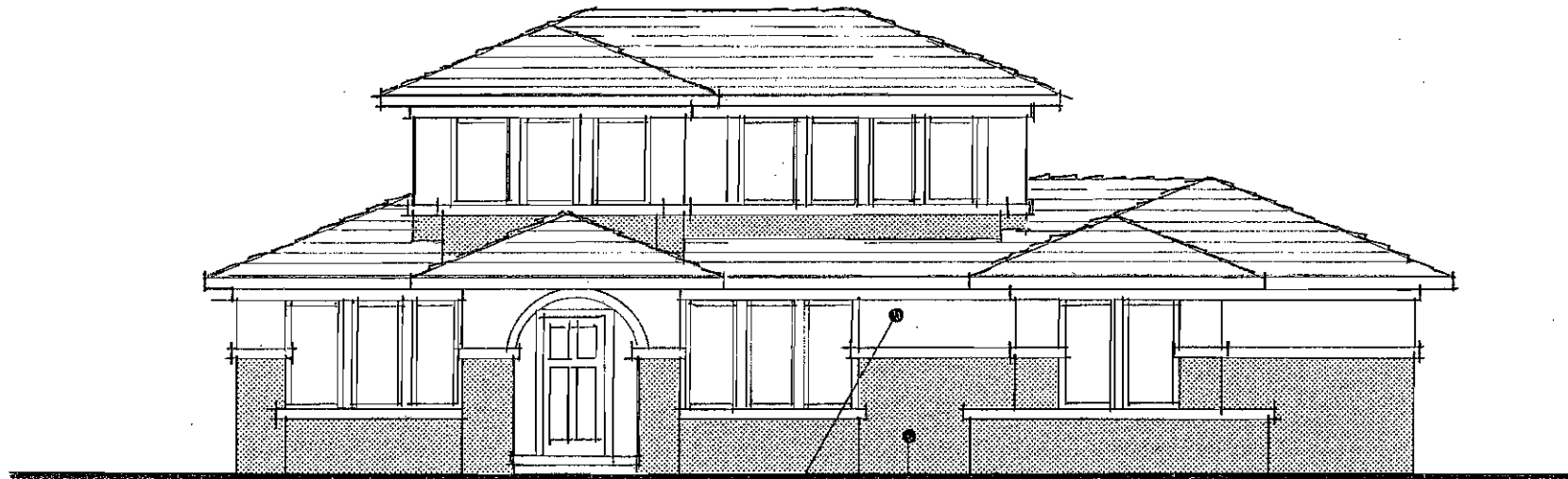

PRIMARY FIELD COLOR

SECONDARY FIELD COLOR

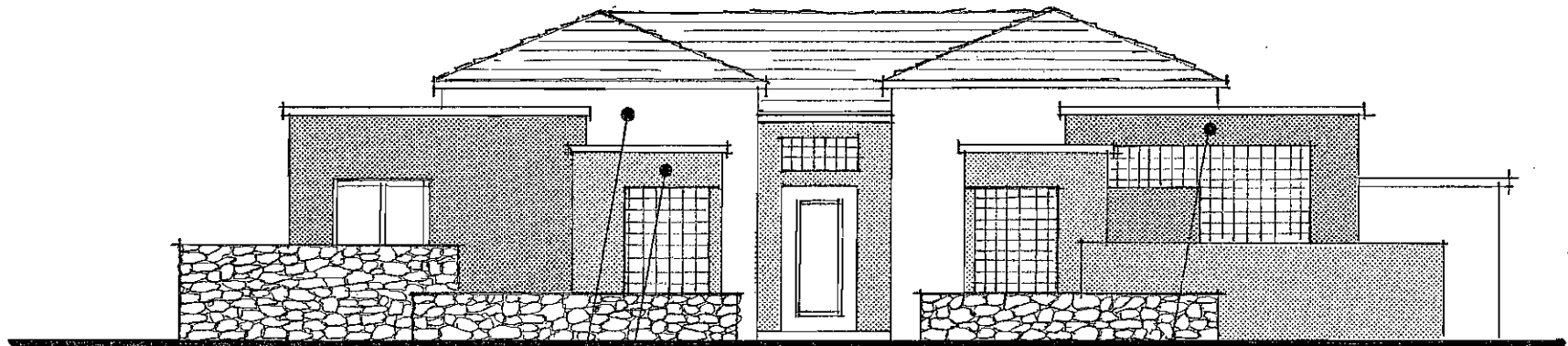

PRIMARY FIELD COLOR

SECONDARY FIELD COLOR

TERTIARY FIELD COLOR

4.B.4.11 Roof Design

Roofs are a significant component in the overall appearance of a building, and careful consideration must be undertaken to ensure that the design and scale of the roof is compatible with the architectural style of the dwelling and surrounding neighborhood. Roofs should be simple shapes without overly complex joining. Predominantly low to moderately pitched hip roofs are encouraged, with small portions of flat roofs permitted to enhance the desert character of the architecture. Roof articulation should strive to establish a relationship not only to the human scale, but should also enable the roof forms to blend into the natural desert environment.

4.B.4.11.a Roof Form and Slope: Low-pitched hip roofs are the predominant type of roof in Desert Elegance architecture. Roof pitches on detached production homes are not permitted to exceed a maximum slope of 6:12. Roofs with gable ends, used on a limited basis, are subject to review and approval by the Design Review Committee.

Pyramidal roof forms are often used to highlight architectural forms and floor plan elements of the residence.

Flat roofs, if utilized, should be surrounded by parapets a minimum of 10" up to a maximum of 36" above the adjacent roof surface. Parapets must return and end in an intersection with a building mass.

Flat roofs that do not have parapets may be approved by the Design Review Committee if such roofs are free of any skylights, roof penetrations, roof vents, plumbing vents, or other similar elements, and if in the

opinion of the Design Review Committee, any drainage crickets are not distracting to the overall design character of the residence. On flat roofs, the flashing detail between the roof and the parapet wall must be kept horizontal, not sloped to follow the roof or cricket slope, and all flashings must be painted to match the walls.

Roofs featuring broad overhangs are encouraged to provide shade protection from harsh desert climatic conditions. However, roof overhangs and/or cantilevered elements may not exceed more than 5'-0" into the side yard setback.

A variety in rooflines is encouraged to avoid a common roofline along the street scene. Rooflines of adjoining residences should vary ridge heights and the direction of main ridgelines to enhance the roofscape of the overall neighborhood.

Predominant roof ridgelines should be designed parallel to the natural contours of the site to minimize the visual impact of roofs and any gable ends.

Creatively designed skeletal roof structures offer the opportunity to provide shelter and shade while creating roof top color through the growth of vines and other plant material.

Skylights and roof top windows are permitted and should be designed as an integral part of the roof. In addition, these elements shall be tinted bronze or gray; white or clear glass is not allowed; and all framing material shall be colored to match the adjoining roof surface.



MACDONALD
HIGHLANDS

Exhibit "av"
Page 4B.80

Several types of fascias are commonly used in Desert Elegance architecture. These include concealed, flush or tight fascias, as well as broad overhanging eaves providing protection from the sun.

Fascias may be either stucco, stone or tile.

4.B.4.11.b Roof Materials and Colors

Permitted Roof Materials:

Roof materials for each residence shall consist of one of the following in either flat tiles or concrete shakes:

- Concrete Tile
- Clay Tile
- Slate
- *Low Profile* Barrel or "S" Tiles

Refer to Exterior Color Section for permitted roof colors.

Standing seam metal roofs, including patinaed copper, may be used, subject to approval by the Design Review Committee. Such roofs, however, shall have a matte finish to minimize glare.

Prohibited Roof Materials:

- Non-Low Profile Barrel or "S" Tiles
- Plain Red Tiles
- Asphalt Shingles
- Fiberglass Shingles
- Reflective roof surfaces causing excessive glare
- Simulated Tile including Fiberglass or Metal

Gutters and downspouts, when used, must be concealed unless designed as a continuous architectural feature. The use of patinaed copper gutters and downspouts is encouraged when used as an architectural feature.

4.B.4.11.c Mechanical Equipment Screening: Mechanical equipment such as air conditioners, heaters, evaporative coolers, television and radio antennas, satellite and radar receivers and other such devices shall not be permitted on any roof. Mechanical devices such as exhaust fans, vents and pipes shall be painted to match adjacent roof surfaces.

The use of solar panels, hot water storage systems, or other similar devices shall not be visible from any street or community open space, and are subject to approval by the Design Review Committee.

All utility meters and panels must be painted to match the adjacent building color at which they are located or must be located in service yards, mechanical rooms, or within meter closets. Utility panels in excess of 400 amps require a closet, which is to be integrated into the design of the residence. All utility panel and meter must conform to the pertinent regulations of the City of Henderson, Nevada Power Company and Southwest Gas Corporation.

4.B.4.12 Architectural Features and Accents:

The use of architectural features and accents is encouraged to create interest on building facades. Careful placement and treatment of accent windows, for example, not only reduces the scale of the building, but also adds character to the elevations. Stairways and columns should be carefully integrated into the design of the building. Accent colors and material treatments should complement the primary building color. Extreme contrasts in style, material and/or color should be avoided.

4.B.4.12.a Entry Courtyards: The use of front entry courtyards is encouraged as a transition from the public space of the street to the private dwelling.

The arrangement of interior living spaces can be used to enclose an entry courtyard, creating a focal point for surrounding rooms, as well as providing a charming entry to the residence.

In addition, garden walls and fences can be used in conjunction with the building architecture to create the entry courtyard.

Garden walls and fences, when used, should complement the adjacent finish and architectural character of the adjoining residence.

Garden walls should be embellished through the use of wall caps, ceramic tiles, steps, recesses, cutouts, and/or wrought iron details.

The use of gates or doors at the entrance to the courtyard is encouraged.

Plant material should be used to visually soften courtyard walls and fences.

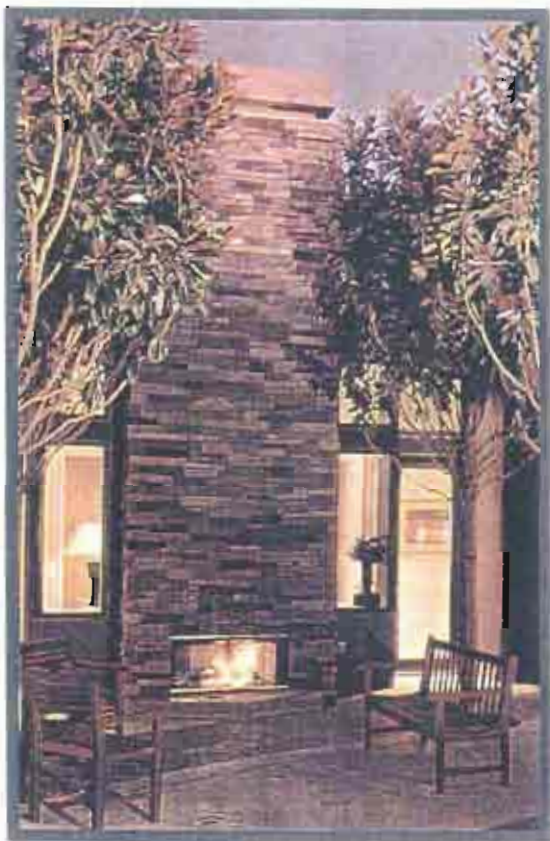
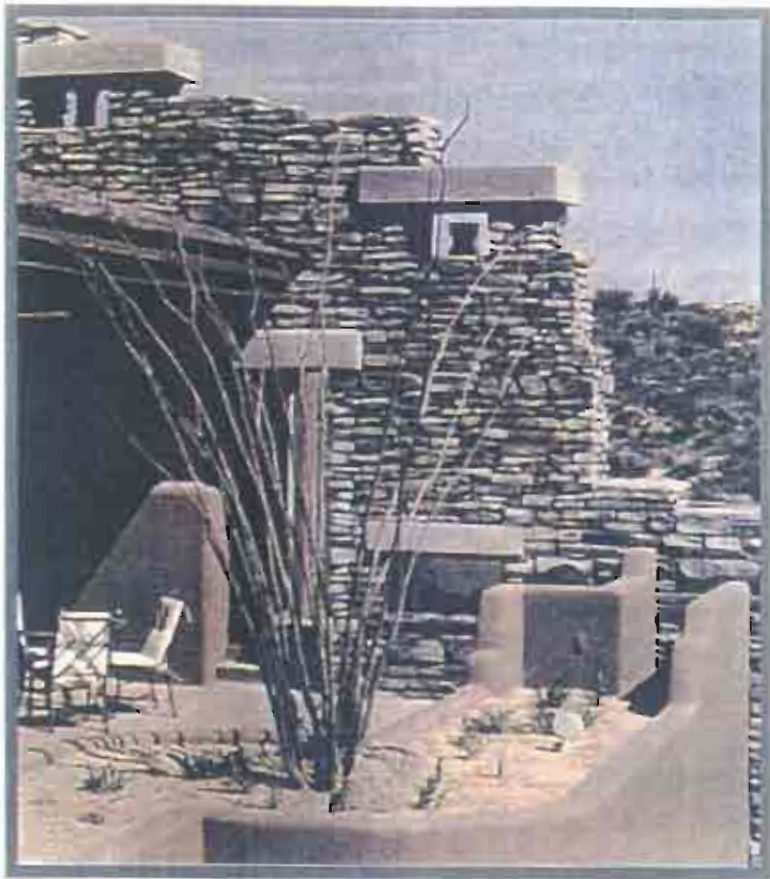

MACDONALD
HIGHLANDS

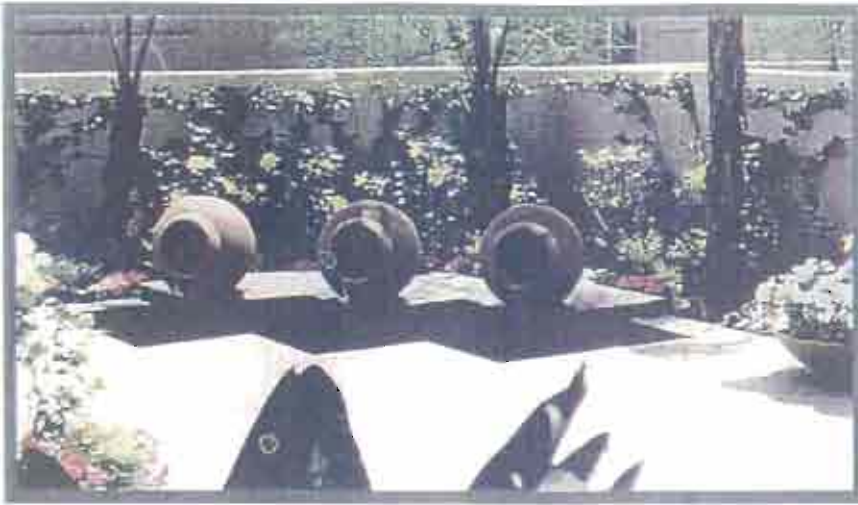

MACDONALD
HIGHLANDS

4.B.4.12.b Walkways, Balconies, Terraces and Patios: Terraces and patios provide a strong indoor/outdoor relationship to the residence, enhancing the integration of the structure with the surrounding natural desert environment.

Broader verandas on both the front and rear elevations are important and shall be used to create appropriate design features.

Cantilevered balconies shall be wood, metal, or ornamental wrought iron and must be consistent in character and detail with the project and particular residence.

The generous use of windows and doors onto terrace and patio areas strengthens the visual continuity from interior living spaces to the out of doors.

An extension of the overall roof form to cover portions of the terrace and patio areas provides effective protection from the desert sun.

Broad roof overhangs and trellises also provide shade protection for terraces, patios, and the residential dwelling.

Walkways, terraces and patios should be constructed of materials that blend with the natural desert environment to the extent possible. Examples of such materials include stone, brick, and concrete colored to match the surrounding landscape. Ordinary concrete that is not colored or textured is not acceptable.

Tempered glass railings are permitted, however, their glazing must be either clear or tinted; reflective glass is not permitted.

4.B.4.12.c Windows:

Metal window frames are permitted, and may be bronze or earth tone colors compatible with the surrounding desert environment. Bright accent colors and mill finish frames are not permitted.

Window glazing may be either clear or tinted; reflective glass is not permitted.

The use of glass block is permitted.

4.B.4.12.d Screen Walls: Screen walls and fences shall be compatible with the architectural character of the residence in terms of design, material and color selections. They may be used to separate the Private Area from the rest of the Building Envelope and as screening for parking and service areas. They may not be used to arbitrarily delineate property lines or the Building Envelope.

In no case shall the height of a screen wall or site wall exceed 6-feet (per City of Henderson requirements), measured vertically from the lowest point at finished grade adjacent to the wall to the highest point of the wall along the exterior side of the enclosure, unless otherwise specifically approved by the Design Review Committee.

4.B.4.12.e **Garage / Auto Courts:** The placement of garages should carefully consider the impact of the garage doors on the streetscene.

The use of auto courts in which the garage doors are oriented completely away from the street is strongly encouraged. The auto court should be screened from view from the street, adjacent residences or public spaces through the arrangement of building elements, courtyard walls, gates or landscape material.

Detached garages must feature the same architectural style, materials, detailing and other characteristics as the main residence.

Garage doors shall be inset a minimum of 12" from the adjacent wall surface and should not be excessively ornamental. Roll-up garage doors are required; out-swing doors are not permitted. Wood garage doors, where permitted by the Design Review Committee, must be maintained regularly. If problems occur with wood garage doors, the HOA and/or Design Review Committee reserve the right to require such doors to be replaced.

Garages, particularly when viewed from the street, shall feature offset garage doors to minimize their impact. For example, a 3-car garage shall feature one single garage door offset from the remaining two garage doors by a minimum of 3', or separated by a minimum of 12'.

4.B.4.12.f Parking: Each residence must have at least four parking spaces. Two of these spaces must be in a two-car garage that must be both enclosed and attached to the residence, or in a separate, totally enclosed structure. Carports are not permitted, except where enclosed on three sides and made an integral part of the structure. On-street parking is limited to visitors and guests only. Due to City of Henderson Fire Code, on-street parking is limited to one side of the street only. The approved street parking for visitors and guests will be limited to the southside and the eastside of the street only (*per MacDonald Highlands Master Association Rules and Regulations adopted July 10, 2002*).

4.B.4.12.g Chimneys: Chimneys shall be designed to be in scale and proportion with the architecture of the building, and incorporate materials consistent with the detailing of the building's elevations.

A chimney mass may not exceed an overall horizontal dimension of 12', unless otherwise specifically approved by the Design Review Committee. Unconcealed metal chimney terminations are not allowed.

Use of terra cotta or fabricated sheet metal enclosures is required for metal chimneys. Masonry chimneys must provide a cap detail that is consistent with the architectural character of the residence.

Chimney heights shall conform to City of Henderson standards.

4.B.4.12.h Building Projections: All projections from a building, but not limited to, chimney caps, vents, gutters, scuppers, downspouts, utility boxes, porches, railings, and exterior stairways shall match the color of the surface from which they project, or must be a compatible accent color, unless otherwise approved by the Design Review Committee.

4.B.4.12.i Accessory Structures: Accessory structures shall include any building or structure that is totally detached from the main building. Examples of these shall include, but are not limited to the following:

- Detached Garages
- Detached Cabanas
- Detached Guesthouses
- ~~Storage Buildings~~
- Equipment Enclosures
- Shade Structures including:
 - Gazebos
 - Cabanas
 - Trellises

Any accessory structure should be located and designed to respect the views, privacy, and other aspects of the adjacent properties. Such structures should be located and designed to be compatible with and compliment the design and form of the main residence. The use of mature landscaping is encouraged to soften the appearance of these structures.

4.B.4.12.j Flagpoles: Freestanding flagpoles are not allowed on any lot in MacDonald Highlands. Displaying the American flag, State of Nevada flag or other appropriate flag may be displayed on special occasions if it is hung from a pole bracket mounted to the residence or if it is suspended from a roof overhang.

4.B.4.12.k Service Areas: All above-ground trash containers, clotheslines, mechanical equipment, fuel tanks, water tanks, and other outdoor maintenance and service facilities must be completely screened from view from adjacent lots, streets, or open space areas by wall and gates at least 12" higher than the equipment. Gates, or a maze entry that provides complete screening, shall be required around all mechanical and pool equipment enclosures.

4.B.4.12.l Utility Equipment: All utility meters and panels must be painted to match the adjacent building color at which they are located or must be located in service yards, mechanical rooms, or within meter closets. Utility panels in excess of 400 amps require a closet, which is to be integrated into the design of the residence. All utility panel and meter must conform to the pertinent regulations of the City of Henderson, Nevada Power Company and Southwest Gas Corporation.

4.B.4.12.m Materials: Due to climatic extremes, the use of wood as an exterior material should be carefully considered. The use of wood on exterior walls as an accent is a high-maintenance item, and is prohibited as the primary exterior material. All exposed wood beams, fascias, columns, trellises, etc., should be of glulam construction. Expression of wood trim is generally used in lintels, porches, trellises, out-lookers, and rafter tails.

- Plaster finishes with a hand-troweled finish or light-sand float finish is encouraged. Spanish Lace and other heavy textures are discouraged.
- Patinaed copper gutters and hidden down spouts are permitted and encouraged.

4.B.4.12.n Exterior Storage: Exterior storage shall only be permitted in the Side Yard if attached to primary structure or in the Rear Yard of any Lot or Parcel if in a totally enclosed Building or opaque screened area. Storage structures are not allowed along the golf course, common open space and hillside areas.

The height of the screened area shall be a minimum of six (6) feet (per City of Henderson requirements).

4.B.4.12.o Antennas/Satellite Dishes: No antenna or other device such as satellite dishes, for the transmission or reception of television or radio signals or any other form of electromagnetic radiation shall be erected, used, or maintained outdoors on any Lot or Parcel, whether attached to a building or structure or otherwise, unless approved by the Design Review Committee.

4.B.4.12.p Solar Application: Passive solar application, or the orientation and design of the Residence for maximum winter sun gain will reduce the winter heating needs, and will be encouraged. Solar collectors can result in excessive glare and reflection, and can only be approved by the Design Review Committee if they are integrated into the Structures or Landscaping on a Lot or Parcel and are not Visible from Neighboring Properties.

4.B.4.12.q Foundations: All exterior wall materials must be continued down to finish grade thereby eliminating unfinished foundation walls.

4.B.4.12.r Additional Construction, Revisions, Modifications and/or Exterior Changes: Any changes to the approved plans before, during, or after the construction of an Improvement must first be submitted to the Design Review Committee for approval.

All submittals shall be accompanied by a cover letter, letter of transmittal or a copy of the Design Review Committee's "Application for an Alternation and/or Modification to an Existing Structure or Lot" describing the revisions proposed.

4.B.4.12.s Mailboxes: Production home parcels within MacDonald Highlands will utilize "gang boxes" in a style and manner approved by the United States Postal Service.

4.B.4.12.t Security: MacDonald Highlands is designed to allow the Association to provide an exclusive and private environment. The 24-hour, manned guardhouse and gates are constructed at the entrance to MacDonald Highlands.

A six-foot high wall will surround the north and west.

4.C.0 LANDSCAPE CRITERIA—ATTACHED AND DETACHED HOUSING

All Developments within MacDonald Highlands shall maintain the landscape standards outlined in Section 5.0 of these Design Guidelines. However, additional criteria are required within attached and detached housing developments.

4.C.1 LANDSCAPE DESIGN CONCEPT

The Desert Oasis landscaping theme of MacDonald Highlands will enhance and complement the natural scenic setting, which is a result of the natural topography of the community. Plant materials shall be used to embellish and soften the exterior hardscape spaces. Every effort should be made to preserve as much of the native plant community as possible throughout the hillside areas, open spaces, and on individual lots. The entire project shall utilize a mixture of native and introduced plant material with emphasis on zeriscape design philosophy.

4.C.2 LANDSCAPE ZONES

The character, intensity, and type of plant materials for MacDonald Highlands are divided into three distinct landscape zones; the Desert Oasis zone, the Enhanced Desert zone, and the Native Desert zone. Each zone represents a density, intensity, and type of landscaping that will be used within that zone. Each zone will have a specific pallet of plant materials that is appropriate for that zone and the adjacent associated landforms.

No Desert Landscape Package shall be offer to Home Buyers that has more than 20% of the yard area in volcanic cinders. There should be an average of one drought tolerant plant per 20 square feet.

4.C.3 LANDSCAPE INSTALLATION & MAINTENANCE

Within four (4) months of the issuance of a Certificate of Occupancy for a Structure on a Lot or Parcel, the Developer shall install landscaping on all areas of the Lot or Parcel, including any Golf Course frontage lot, visible from adjoining Streets, Lots, or Parcels, and said installation shall be in accordance with the plans and specifications first approved by the Design Review Committee.

After installation, the Owner of the Lot or Parcel shall, at its expense, maintain said landscaping in accordance with standards and procedures established and approved by the Committee. If any Owner fails to landscape or maintain landscaping in accordance with the foregoing, the Declarant or Association may landscape said area and/or maintain landscaping in said area, and the cost thereof shall be addressed to the Owner as an Assessment in accordance with the Declaration of Covenants, Conditions, and Restrictions.

5.0 LANDSCAPE DESIGN GUIDELINES

5.1 LANDSCAPE DESIGN CONCEPT

The Desert Oasis landscaping theme of MacDonald Highlands will enhance and complement the natural scenic setting, which is a result of the natural topography of the community. The incorporation of this lush desert landscaping theme into the exceptional elevation and natural geological formations of the community will make MacDonald Highlands unlike any other in the Las Vegas valley. Plant materials will be used to embellish and soften the exterior hardscape spaces. Soft canopy trees with an underscore of flowering shrubs, ground covers, and annual color will provide a gracious welcome at the community's entryway. While the entries and select areas of streetscape will reflect the lush "desert oasis" plant palette, creating an enhanced canopy of trees to provide a welcome protection from the sun yet utilizing a mixture of drought-tolerant foliage and watering technology which reflects the sense of environmental responsibility which should set the tone for development in this decade. The thoughtful blending of lush-looking, drought-tolerant foliage, native desert plants, and flowering shrubs will provide a rich texture of plant materials and create a delightful living environment. While every effort will be made to preserve as much of the native plant community as possible throughout the hillside areas, open spaces, and on individual lots, the entire project will utilize a mixture of native and introduced plant material with emphasis on xeriscape design philosophy.

5.2 LANDSCAPE ZONES

The character, intensity, and type of plant materials for MacDonald Highlands are divided into three distinct landscape zones; the Desert Oasis zone, the Enhanced Desert zone, and the Native Desert zone. Each zone represents a density, intensity, and type of landscaping that will be used within that zone. Each zone will have a specific pallet of plant materials that is appropriate for that zone and the adjacent associated landforms.

5.2.1 Desert Oasis Zone: The Desert Oasis zone landscaping, associated with areas of high pedestrian use and community focal points, is made up of lush green drought-tolerant plant materials combined with some turf. Found at community entries, along 64-foot right-of-ways, and at major community focal points, the colors used in the Desert Oasis zone will provide contrast to the native desert environment. Using 24-inch, 36-inch, and 48-inch specimen trees, 5-gallon shrubs, and ground covers, a pleasing visual image of a desert parkway will be created. Tree massings will be lush and informal, accented with colorful specimen shrubs and ground covers. The landscaping design and plant specimens will be incorporated with fitness paths, walkways, and trails to create the oasis ambiance.

5.2.2 Enhanced Desert Zone: The Enhanced Desert zone landscaping is comprised of plant materials commonly found in the desert environment rich with color and texture, which will be introduced to the native plant materials to create aesthetically pleasing streetscapes throughout the community. A concentration of plant materials in colorful high density and high intensity landscape pockets will enhance the native desert environment in this landscape zone.



5.2.3 Natural Desert Zone: The Natural Desert zone consists mostly of undisturbed open areas and areas that require the re-establishment of the natural desert finish where landscaping is not appropriate. The materials for this area will be mostly existing rock and upper Mojave Desert shrub and grass plant materials.

5.3 STREETScape

The streetscapes within MacDonald Highlands will communicate the landscaping themes throughout the community. The quantity, size, and placement of trees and shrubs will be important to achieving the theme and character of MacDonald Highlands. The location of trees, ground cover, and shrubs will complement the individual home design and driveway location. The area and degree of intensity of landscaping will be a function of the steepness of the slopes adjacent to the landscaped area. Where the terrain is flatter, the Desert Oasis landscaping zone will be used along the road right-of-ways and at the community entry features. As the natural slopes increase in steepness, the landscape zones will change to Enhanced Desert and Natural Desert in order to minimize the impact of grading on the native hillside. Along the steeper collector roads, the Enhanced Desert theme will be accomplished by creating pockets of intensified landscaping and by introducing selected flowering wildflowers to the slope areas which will add bright splashes of color at various times throughout the seasons. Combining the techniques of reestablishing slopes that have been disturbed by grading, concentrating select specimen plant materials in pockets along the length of the roadway, and introducing color through the use of various wildflowers and ground covers, the Enhanced Desert streetscape will transition from the Desert Oasis zone to those areas where the Natural Desert zone is most appropriate.



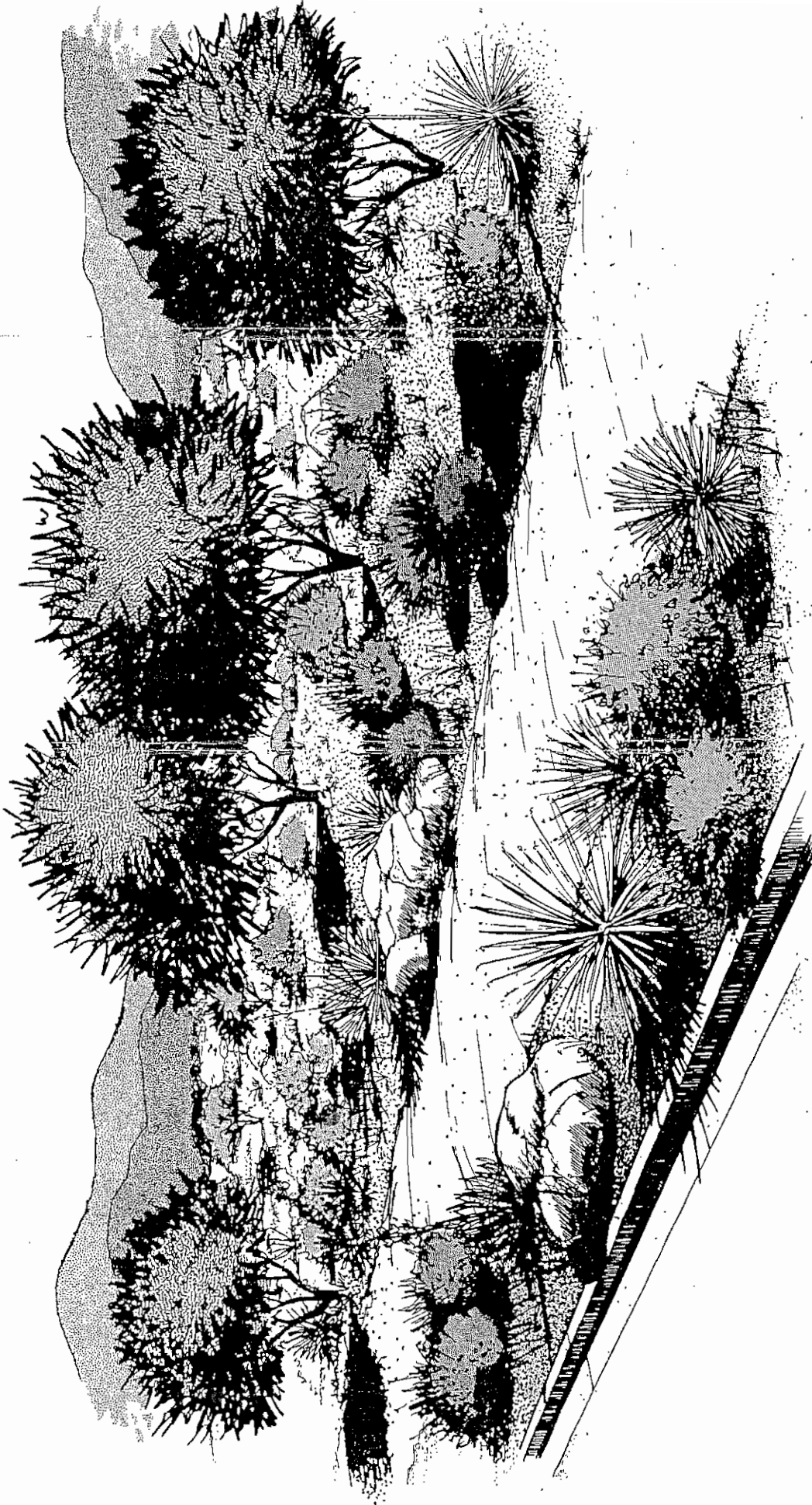

Enhanced Desert Along Roadway and Fitness Path

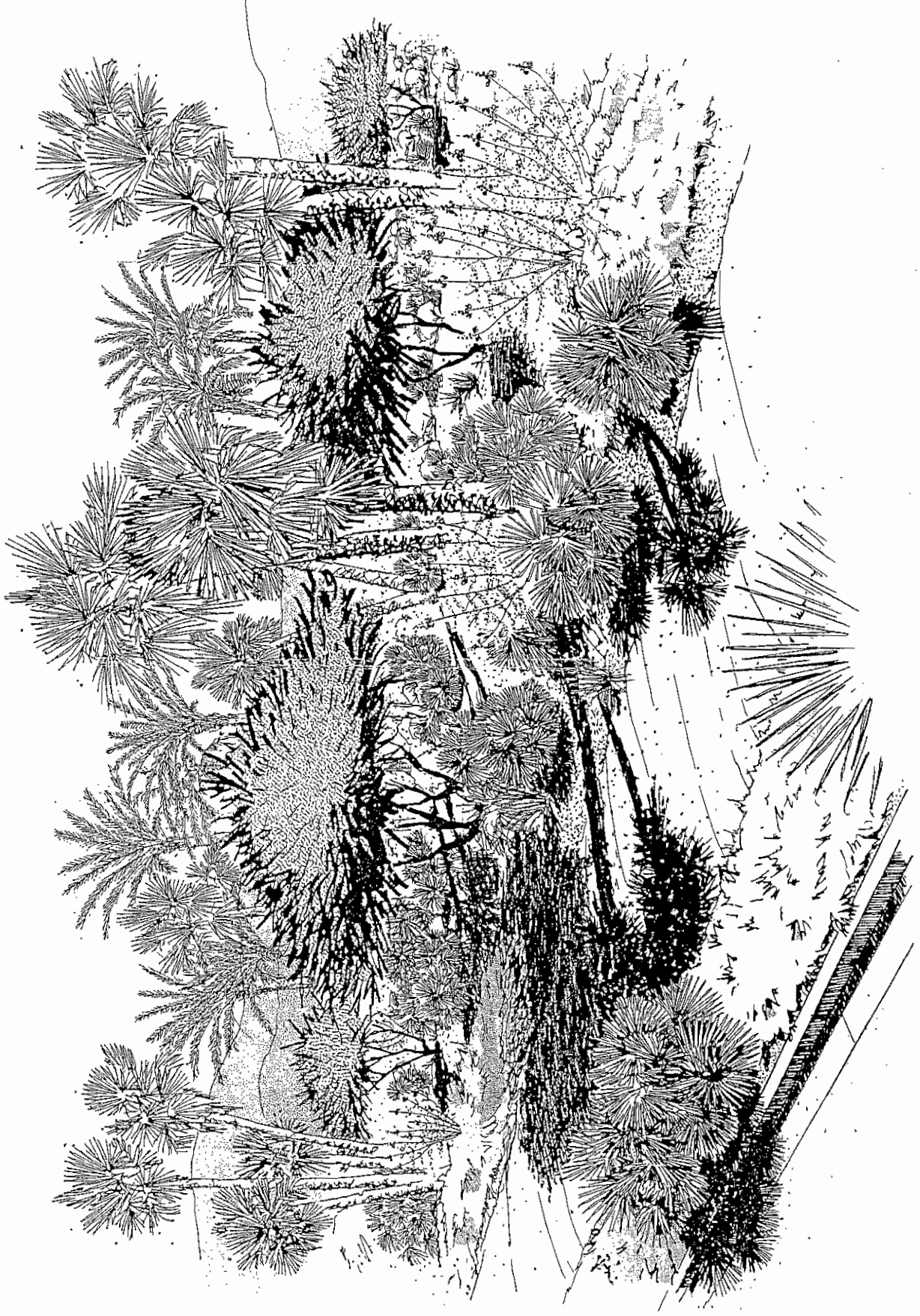

"Desert Oasis" Along Roadway and Fitness Path

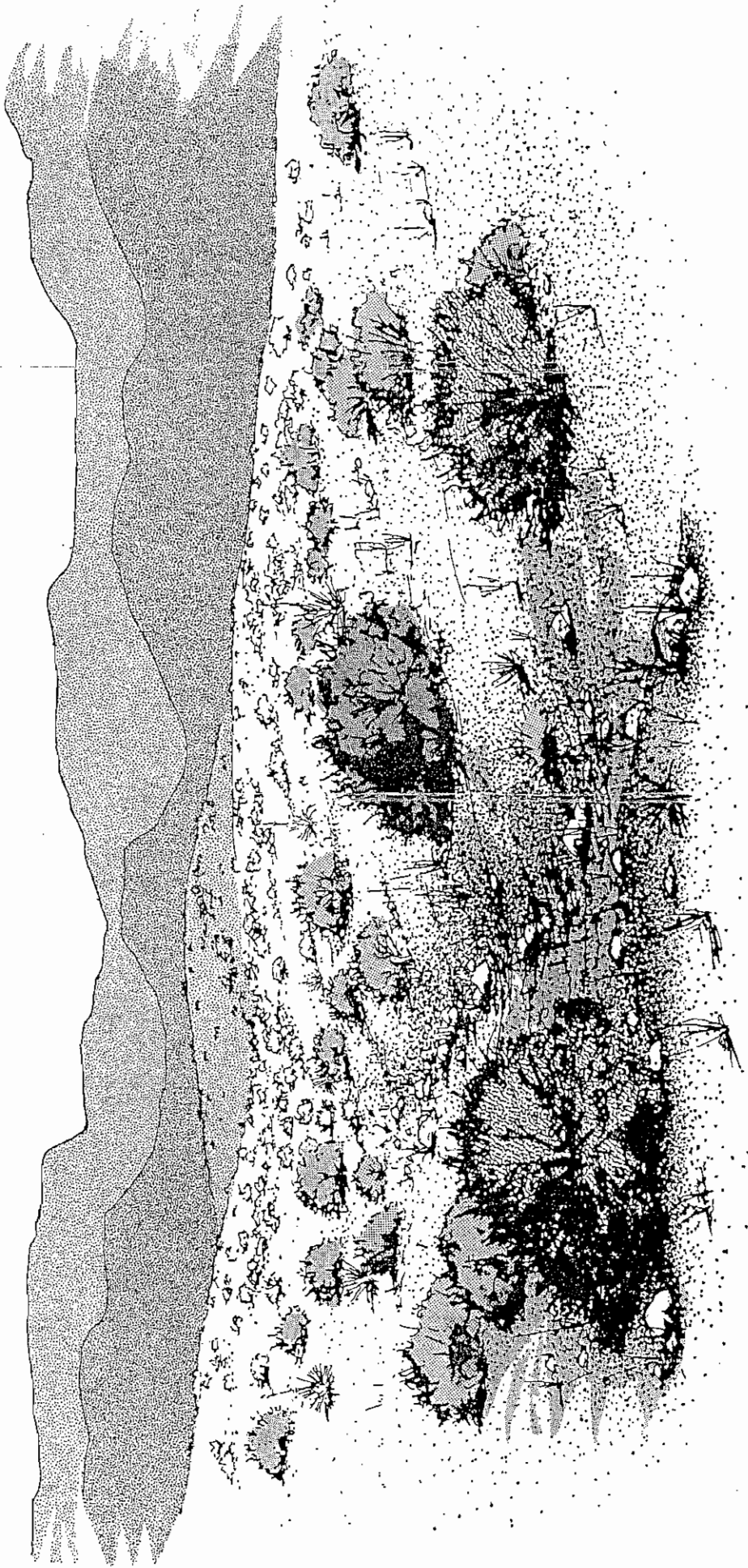

Natural Desert Zone (Revegetated)

The following statements are general guidelines for the use, placement, and design of landscape materials in various public or common and private areas within the community. These are organized by area to include:

- Minimum of one 24-inch box tree to be planted every 20 feet of linear street frontage. The required trees must be "mature." (Mature: generally referred to as "24-inch box" minimum.) A minimum of two varieties will be required along all frontages.
- A minimum of three 5-gallon shrubs is required per 20 feet of linear street frontage. It is encouraged to plant an appropriate number of shrubs to complement the placement of trees.
- The clustering of shrubs and trees is encouraged to accent focal points and provide variety to the streetscape.
- Contouring and berming along street frontage is recommended and should not exceed the following standards:

Berm heights/slope:

- 2 feet 6 inches to allow views
 - 6 feet for screening
 - 4:1 maximum desired slope
- A minimum 6-foot and maximum 8-foot wall shall be required along the rear of reverse frontage single family Lots or Parcels along all streets. Raised planters are encouraged to break up the monotony of the planter wall. It is encouraged to use shrubs as accents or espaliers on the walls to create interest.
 - Landscaping for key intersections shall be designed to add accent to the community and provide direction toward major community elements.

- Streetscapes shall be of variable widths, expanding at entries, transition areas and view corridors. Planting shall go beyond road rights-of-way, with plant and hardscape materials penetrating into adjacent neighborhoods.
- The horizontal form of continuous walls shall be softened by landscape planting.
- Monumentation, textured paving, flowering accents, shrubs, and specimen trees shall be used for general interest at entry points.
- Service areas and utility fixtures shall be located and screened with landscaping in order to reduce their visual impact in the community.
- The planting along the major streets will appear consistent from start to finish. General roadway planting is to be highlighted with annual flower plantings at gateway monuments.
- All landscaping shall be planted in informal groupings with an emphasis upon reflecting the natural character of the site.
- Vegetation of varying heights and textures shall be placed along perimeter walls and fences to soften hard planes by creating interest and variety.
- Special paving materials, landscaping, signage, and street furniture should be utilized to create a sense of importance and arrival at key intersections.
- Develop an overall design concept to establish a strong landscape theme.

- Select plant materials within the applicable landscape zones to achieve a cohesive development.
- The landscape transition between various land uses should be graceful and not abrupt.
- Landscape should promote and encourage outdoor pedestrian activities.

5.4 LANDSCAPE COVERAGE

Within residential developments, a minimum of at least 20% of the area within the property lines shall be devoted to landscape materials. (Net land area.) Other requirements include:

- An automatic irrigation system is required in all landscaped areas. Drip irrigation should be utilized where possible.
- Minimum tree trunk height is 6 feet. Minimum 1-1/2-inch caliper measured 4 feet above the grade. Palms: minimum trunk height of 5 feet (all above generally referred to as "15 gallon").
- A minimum of 20% of all frontage landscape areas require a ground cover consistent of grass or other living plant material which does not exceed 18 inches in height.
- Plastic edging is unfitting on a custom lot. Mow curbs are encouraged to be concrete or an equivalent material.
- Where multi-family uses are located adjacent to or separated by an alley from any residential use, a 10-foot wide landscaping strip planted with one 24-inch box tree every 20 feet is required along the common property line.

- In any multi-family development, a minimum of two 24-inch box trees per dwelling unit is required, exclusive of street trees and perimeter landscaping. A minimum of 35% of required trees shall be mature (24-inch box).

5.5 PARKING LOT OR PARCEL LANDSCAPING

- A minimum of 15% of all parking lots shall be landscaped, exclusive of front yards or perimeter landscaping and street trees.
- One tree for every 8 parking stalls. All of the required trees must be mature (i.e., 24-inch box minimum).
- Landscape islands of no less than 5 feet wide and containing a minimum of 50 square feet is required at least every 12 parking spaces.
- Separation of parking lots from adjacent residential uses requires a minimum 10-foot landscape strip with a minimum of one 24-inch box tree every 20 linear feet.
- All parking lots are required to be screened from street views by the use of walls or earth berms or combination thereof. Height of screen must be at least 3 feet above grade of the parking lot or adjacent street, whichever is higher in elevation.
- Intermittent landscaping is permitted to substitute for the walls and berms for a maximum of 25% of the parking lot frontage.

5.6 ENTRIES

- Community entries: Desert Oasis landscape zone.
- Project Entries: Desert Oasis/Enhanced Desert landscape zones.

Entries are the first opportunity a developer has to introduce and identify his project, but they are also physically part of the overall streetscape. While it is important to give some separation and individual identification, it is equally important to carry out the landscape theme.

Monument signs identifying the entrance should be located on one corner of the community level intersections. In general, monument signs should be located on the right hand side of the community interfacing with the in-bound travel lane.

5.7 RESIDENTIAL LANDSCAPING

Developers/Owners are responsible for planting and maintaining all required landscaping within their property until such time that the common landscaped areas are released to the Association and/or individual Lots or Parcels are released to the homeowner. At this time, the Association will be responsible for all maintenance of landscaped areas along the arterial roads. The homeowners will be responsible for all maintenance of landscape within the Lot or Parcel frontage.

~~Plant material must be selected from the designated plant palettes for the specified landscaping zone, however, if a developer/owner chooses to use a different plant material, detailed plans can be submitted to the Design Review Committee for consideration and approval.~~

5.7.1 Custom Residential Lots

- All development styles should foster a custom impression and individual expression.
- Garages set in front of main buildings should be one story.
- Second stories should be set back from internal streets to help create a human scale.
- Varying the lot widths and configuration at cul-de-sacs and corners is encouraged to promote a custom housing feel for single family residential areas.
- Whenever possible, homes should be arranged in a staggered and variable setback fashion to provide visual interest and avoid the repetitive appearance of arcades and yards for single family residential areas.
- Site design and building location criteria must include an awareness of the adjacent properties' development potential. The effect on views, privacy, access, etc. are important rights to be protected and a value to lot owners which cannot be reduced by unreasonable siting which takes undue shares of amenities.
- Structures on a sloping site shall be situated so as not to impact the natural silhouette of ridge lines, natural landscape, and open space.
- The siting of all structures shall relate to the natural terrain in order to minimize grading operations.

- Varied driveway locations are encouraged to break up repetitive curb cuts and yard patterns.
- Use of staggered garage setbacks to enhance the street scene appearance is encouraged.
- Separation of pedestrian/vehicular traffic shall be maintained.
- Open parking and carports shall be clustered into parking courts.
- Guest parking, where possible, should be located along through-circulation drives and near unit entrances for multi-family homes.
- It is important to select plant materials within the various planting zones to achieve a cohesive development.
- Transition between various land uses should be graceful and not abrupt.
- Landscaping should promote and encourage outdoor pedestrian activities.
- Landscape design should best depict the exclusively elegant and gracious desert living within the community.
- Entries are the first opportunity a developer has to introduce and identify his project, but they are also physically part of the overall streetscape. While it is important to give some separation and individual identification, it is equally important to carry out the landscape theme.

- Monument signs identifying the entrance should be located on one corner of the community level intersections. In general, monument signs should be located on the right hand side of the community, interfacing with the in-bound travel lane.
- Streetscapes shall feature the low-density residential character. Views shall be framed with landscaping to allow visual penetration.
- The design of fencing, exterior lighting and street furniture is an integral part of the landscape design process. Fencing shall be transparent and sensitive to views.
- Trash receptacles and/or service yards shall be screened from roadways with plant material and enclosures compatible with adjacent structures and landscaping.
- All landscape areas shall be fully irrigated with an automatically controlled underground irrigation system.
- Areas of separate maintenance responsibility shall be controlled by separate controllers and/or separate control valves.
- All lawn and shrub irrigation systems should be separate.
- The use of water conserving systems, such as drip irrigation for shrubs and tree planting, is encouraged.
- To minimize negative visual intrusion, all automatic valves shall be installed in valve boxes and the pop-up variety of head used whenever application allows. All back flow control devices and controllers placed in shrub areas shall be screened so that they are not visible.

- Screening materials shall be compatible with surrounding architecture and landscaping.
- Any slope area adjacent to the golf course and not a part of the area of home development or construction shall be landscaped as a “Natural Desert Zone” or “Natural Area”.

5.8 COMMERCIAL AREA

- Develop an overall design concept to establish a strong landscape theme.
- Select plant materials within the applicable landscape zones to achieve a cohesive development.
- An orderly relationship between street and on-site landscaping should be designed with specifically designated perimeter setbacks.
- Transition between adjacent land uses should be graceful and not abrupt.
- Landscaping should promote and encourage outdoor pedestrian activities.
- Landscaping should be installed to mitigate heat impact from paved surfaces.
- Landscaping and/or berming should be incorporated to screen views of surface parking lots from adjacent roadways.
- The horizontal form of continuous walls shall be softened by landscape planting.

- The use of flowering plant materials to create accents for general interest to the outdoor spaces is encouraged.
- The use of plant materials to provide outdoor space definition and enclosure is encouraged.
- Service areas and utility fixtures shall be located and screened with landscaping in order to reduce their visual impact.
- Special paving materials, landscaping, signage, and street furniture should be utilized to create a sense of arrival and importance at key intersections.
- Clear identification and separation of vehicular and pedestrian traffic should be maintained.
- The circulation system should be reinforced with plantings.
- Parking location and layouts should be simple and safe for pedestrian circulation.
- Customer access and circulation should be separated from service/truck areas.
- Buildings in most cases should be landscaped with low-level plantings and shade trees to soften the impact of the architecture and provide a more human scale.
- The objectives of the landscape design shall be to:
 - Clarify the visitor path to the front door.
 - Establish a unique image for the development.
 - Establish a sense of entry from the public street to the more private realm.
- Project signage should comply with all applicable signage guidelines and be integrated with the landscaping.

- Walls should be designed as an integral part of the overall site design. They shall be constructed with materials that are complementary to the style of adjacent buildings and incorporate the same finishes and colors.
- Sign materials and colors should complement the buildings.

5.9 GOLF COURSE/CLUBHOUSE

- Develop an overall design concept to establish a strong landscape theme.
- Select plant materials within the applicable landscape zones to achieve a cohesive development.
- The landscape transition between various land uses should be graceful and not abrupt.
- Landscaping should promote and encourage outdoor pedestrian activities.
- The circulation system should be reinforced with plantings.
- Project signage should comply with all applicable signage guidelines and be integrated with the landscaping.
- Walls should be designed as an integral part of the overall site design. They shall be constructed with materials that are complementary to the style of adjacent buildings and incorporate the same finishes and colors.
- Parking location and layouts should be simple and safe for pedestrian circulation.

- Customer access and circulation should be separated from service/truck areas.
- Service areas and utility fixtures shall be located and screened with landscaping in order to reduce their visual impact.
- To the extent possible, views of the golf course from adjacent development and parkways should be preserved and enhanced.

5.10 LANDSCAPE INSTALLATION & MAINTENANCE

Developers/Owners should make themselves aware of any potential problems such as penetrating caliche soil or rock when preparing a site. It should be noted that all contractors should include an allowance in their bids for penetrating through caliche soil when it is encountered under tree planting pits or any other landscape easement.

All demolition, clearing, grubbing, stripping of soil, excavation, compacting, and grading must be performed within the confines of the Owner/Developer's Lot or Parcel within the Building Envelope.

Adequate provision must be made to prevent surface waters from damaging excavations, public or private property, and cut and fill slopes both during and after construction.

The use of chemical treatment on existing vegetation, if necessary, must be accomplished through a State Licensed Pest Control Applicator.

In order to maintain the aesthetic integrity of the community, all Lots and Parcels must be timely landscaped in accordance with an approved landscaping design plan. Within four (4) months of the issuance of a Certificate of Occupancy for a Structure on a Lot or Parcel and, in any event, no later than ~~within~~ thirty-six (36) months ~~of after~~ the date on which Declarant transfers title to the Lot or Parcel to a party other than the Declarant, the then Owner of the Lot or Parcel shall ~~install complete installation of~~ landscaping on all areas of the Lot or Parcel, said installation to be in accordance with plans and specifications first approved by the Design Review Committee. After installation, the Owner of the Lot or Parcel shall, at its expense, maintain said landscaping in accordance with standards and procedures established and approved by the Committee. If any Owner fails to landscape or maintain landscaping in accordance with the ~~foregoing~~ ~~timeframes contained in this paragraph~~, the Declarant or Association may landscape said area and/or maintain landscaping in said area and ~~collect~~ the cost thereof ~~shall be addressed to from~~ the Owner as an Assessment in accordance with the Declaration of Covenants, Conditions, and Restrictions. *(Updated January 30, 2006)*

It is encouraged that the following landscape maintenance items be done as a minimum requirement:

- Weekly lawn mowing and edging during the growing season. Owner shall cut weeds monthly and remove any debris that may accumulate on the property.
- Fertilization every 60 to 90 days.
- Watering to maintain healthy, viable trees, shrubs, ground cover, and lawns.
- Winter overseeding of Bermuda lawns with rye grasses.

5.10.a Rear Yard Cone of Vision / Dedicated View Corridors

Those lots that require preservation of view corridors will not be permitted to install improvements, plant trees or install other plant material that are taller than 4 feet (i.e., at *maturity*, not with maintenance) within a distance of 15 feet from the rear yard property corner (Exhibit "O", Page 2.38).

6.0 DESIGN REVIEW PROCEDURES

6.1 CUSTOM LOT PROCEDURES

6.1.1 Submission of Plans

Plans and specifications shall be submitted to the Design Review Committee in accordance with the following submittal and review procedures.

6.1.2 Review of Plans

The Design Review Committee shall conduct reviews of plans during PreDesign Conferences only. Owners and/or their representatives shall have the right to attend any PreDesign Conferences of the Committee. To assure a thorough and complete review, Schematic and Final plan submittals will be reviewed by the Committee and/or their representatives outside of any Committee meetings. The Committee will respond in writing to a submittal no later than fifteen (15) working days after the review, but no later than thirty (30) working days after a submittal is complete, provided the plans meet the requirements of the Guidelines. Any responses an Owner may wish to make in reference to issues contained in the Committee's written response must be addressed to the Committee in writing. In addition, all approvals as required by the City of Henderson must be obtained after the Design Review Committee-approval and prior to the commencement of construction.

6.1.3 PreDesign Conference

After the close of a lot or parcel, and prior to completing a Building design, it is *mandatory* that the Owner and/or his professional consultants meet with the Design Review Committee to review the Design Guidelines and Standards and the Owner's proposed design.

At this meeting, the Owner will be expected to outline the project to the Design Review Committee in terms of its land use, Building size (i.e., site plan), Building mass arrangements (i.e., exterior elevations), type of project, materials, and proposed construction schedule. Should the Design Review Committee deem it necessary, subsequent PreDesign Conferences may be required.

Effective April 2004 a non-refundable fee of \$1,500.00 for graded lots and \$2,500.00 for natural lots, made payable to the *Foothills Partners*, is required *in advance* of a Lot Owner's PreDesign Conference.

If a Lot Owner and/or his/her designated representative is unable to attend their PreDesign Conference, they must notify the DRC seventy-two (72) *business* hours in advance of the PreDesign Conference, otherwise a \$250.00 Cancellation Fee will be assessed and said fee must be paid *in advance* of rescheduling their PreDesign Conference for another date [effective April 2004].

6.1.4 Forms

The Design Review Committee shall adopt forms upon which all requests for actions or approvals from the Design Review Committee must be submitted. Such forms shall indicate the number of copies in each set of plans, specifications, site plans or other documents, which must accompany the application, and set forth instructions to be followed in submitting applications.

6.1.5 Schematic Plan Review

The Schematic Plan submittal is required to give an indication of the design, character, and extent of the proposed immediate development. The Schematic Plan is to be submitted and approved prior to the Final Plan submittal.

The Schematic Plan must be drawn to **scale** and fully dimensioned. The Owner will be responsible for submitting one (1) set of prints and one (1) set of all drawings reduced to 8½" x 11" format to the Design Review Committee.

The following Site, Improvement, and Building information shall be shown:

Location Map: 8-1/2" x 11" (drawn to scale) showing location of the Lot or Parcel in the Village.

General: Owner's name, address, and telephone number; the name, address, and telephone number of the firm(s) preparing the Plans, the Lot or Parcel designation, the scale and north arrow, the date, the plans were prepared, legal description of gross Lot or Parcel area, and the date, of submission.

The Site or Subdivision Plan:

Scale: Site Plan at not less than 1" = 20'.

Subdivision Plat, when applicable, not less than
1" = 100'.

Survey prepared by a licensed surveyor or civil engineer showing Lot or Parcel boundaries and dimensions, topography on a scale standard in the industry for similar projects and major terrain features. The plan should include 1-foot contours covering the entire lot between the property lines and should include an area 25 feet beyond the rear property line and 15 feet beyond the side property line. If adjacent lots are developed, locations of structures or walls must be shown as well as by using elevations. Any Owner submitting plans for approval to the Design Review Committee shall be responsible for the verification and accuracy of all Lot or parcel dimensions, grade, elevations, and the location of the key features of the natural terrain. Each Owner shall certify to the accuracy thereof before the Design Review Committee will undertake its review.

Existing and proposed grades

Square footage (gross/net) of:

Lot(s)/Parcel(s)

Building(s)

Parking Lot/Drives

Landscape/Open Space Areas

Site coverage ratio (defined as the Building ground contact area divided by the total gross Lot or Parcel area).

Front, Side, and Rear Yard Setback Lines.

Location of all other Improvements, walls, outside storage areas.

Alleys, adjacent Streets with all existing/future Rights-Of-Ways, curb, Property Line.

Driveways.

Total parking provided.

Conceptual grading, drainage, lighting, and utilities plan.

Lot Cross-Sections (reference Exhibit “V” [Page 3.20]—applicable to Hillside Areas Only)

Buildings: Elevations of Buildings from all sides at an appropriate scale sufficient to clearly indicate the design concepts, placement, and massing of buildings. The following Improvement details shall also be provided:

- Gross and net Building square footage.
- Heights of all Improvements.
- Number of levels or floors.
- Windows, doors, balconies, and other structural openings.

Exterior materials samples must be presented within a three-ring binder, clearly marked with Builder's name, filing date, and Lot number. All samples must be identified with manufacturer's names, color and number, and manufacturer cut-sheets for **ALL** exterior materials (i.e., windows, glass block, skylights, roof top windows, Solatubes®, solar panels, flat roof surface material & color, railings, wrought iron gates, doors (typical), front doors, patio doors, garage doors, landscape lighting, exterior wall-mounted light fixtures, exterior recessed light fixtures; driveway, walkway, terrace, balcony and patio materials & colors; address identification device, etc.) are required within the schematic plan submittal package.

Color Blocking Exhibits for all elevations are required with the schematic plan submittal package. Please be advised renderings are not required; the Design Review Committee requires exhibits identifying the application of all proposed colors and materials. This can be accomplished in many ways, for example, call outs on elevations or color-coded elevations.

Floor Plan(s)

Roof Plan

Electrical Load Calculations accompanied by Mechanical,
Plumbing and Electrical plans

Nevada Power Company approval letter (if applicable)

City of Henderson Variance Approval (if applicable)

Landscaping: A conceptual landscape Plan should indicate:

- Square footage of Landscape Area in Front, Side, and Rear Yards
- Location and species of existing vegetation
- Conceptual landscaping design
- Identify all paving and plant materials
- Identify locations for all landscape light fixtures proposed

6.1.6 Final Plan Review

The final plans shall graphically and in a written text verbally indicate the following items, indicating all approved elements shown in the Schematic Site Plan:

- One (1) complete set of plans drawn to scale and fully dimensioned
- One (1) each of all drawings **reduced to 8½ x 11” format**.
- Remaining Materials Sample Binder Selections and Manufacturer Cut Sheets (where applicable)
- Modified Color Blocking Exhibits (where applicable)
- Revised Mechanical, Plumbing and Electrical Plans (where applicable)

- Revised Irrigation and Landscape Plans (where applicable)
- Pre-Construction/Pre-Approval Requirements, including a proposed construction schedule, construction deposit and pre-construction conference appointment
- An AutoCAD disk with the building perimeter and grades of the finalized site plan
- Massing Model: On *hillside* lots, a simple massing model is required to three-dimensionally demonstrate how the Building relates to the Lot or Parcel and adjacent properties. The massing model requirement should be verified by each owner with the Design Review Committee.
- Such other reasonable information as may be required by the Design Review Committee.

6.1.7 Revisions

Any changes to the approved plans before, during, or after the construction of an Improvement must first be submitted to the Design Review Committee for approval. All submittals shall be accompanied by a cover letter, letter of transmittal or a copy of the Design Review Committee's "Application for an Alternation and/or Modification to an Existing Structure or Lot" describing the revisions proposed.

6.1.8 Resubmittal of Plans

In the event of any disapproval by the Design Review Committee of either a preliminary or a final submission, a resubmission of plans should follow the same procedure as an original submittal. An additional Design Review Fee shall accompany each such resubmission as required by the Design Review Committee.

6.1.9 Working Drawings and Construction Specifications

Prior to plan approval, a Pre-Construction Conference is required for final plan approval by the Design Review Committee. The Lot Owner or a designated representative for the Lot Owner shall schedule an appointment with a MacDonald Highlands representative to discuss forthcoming construction activities on the Lot, prior to the issuance of the Design Review Committee approval letter to the City of Henderson. As a reminder, all approvals must be obtained from the Design Review Committee prior to submittal to the City of Henderson. The requirement to schedule a Pre-Construction Conference does not constitute plan approval by the Design Review Committee.

Upon Final Plan approval from the Design Review Committee, the Owner will be responsible for submitting their Site Plan drawings, Construction Working Plans, and specifications to the appropriate City of Henderson Departments, Commissions, and Council (if required) for their review and approval as to conform with the City Zoning Ordinance, and local and State Building Safety Codes and in accordance with their review process. Upon approval of the Plan and specifications by the City, a construction permit should be issued.

Original construction working plans must be submitted to the Design Review Committee so that they may be stamped as approved by the Design Review Committee prior to any submittals to the City of Henderson. Any drawings submitted to The City of Henderson without this approval stamp will be rejected.

6.1.10 Work in Progress

The Design Review Committee may inspect all work in progress and give notice of non-compliance. Absence of such inspection and notification during the construction period does not constitute either approval of the Design Review Committee with work in progress or compliance with these Design Development Guidelines and Standards or the Declaration.

Construction documentation required of each Lot Owner, Developer and/or Builder is as follows:

- i. **PRIOR TO** pouring the slab the builder or owner must submit a wet stamped letter from a Nevada registered land surveyor attesting that the **main level** slab form elevations match the elevations submitted. If the owner does not comply the Developer will have it performed and deduct the cost from the construction deposit.
- ii. **AFTER** the **main level** slab is poured, the owner or builder must submit a 8.5" x 11" plot plan "as-built" of the home showing actual distances from corners to property lines in tenths of a foot and wet stamped by a Nevada registered land surveyor. If the owner does not comply the Developer will have it performed and deduct the cost from the construction deposit.

- iii. **AFTER** top-out, the builder or owner must submit a wet stamped letter from a Nevada registered land surveyor stating the vertical difference between the highest roof peak and the top of curb at the center of the lot certifying the highest roof peak elevation. If the owner does not comply the Developer will have it performed and deduct the cost from the construction deposit.

6.1.11 Completed Work

Upon completion of any Residence, Building, Structure, or other Improvement for which final approval was given by the Design Review Committee, the Owner shall be given written notice of completion by the Design Review Committee.

Within such reasonable time as the Design Review Committee may determine, but in no case exceeding ten (10) days from receipt of such written notice of completion from the Owner, or the Owner's duly authorized representative, it may inspect the Residence, Building, Structure, and/or Improvements. If it is found that such work was not done in strict compliance with the final plan approved by the Design Review Committee, it shall notify the Owner in writing of such non-compliance within five (5) days after the inspection, specifying in reasonable detail the particulars of non-compliance, and shall require the Owner to remedy the same.

6.1.12 Right of Waiver

The Design Review Committee reserves the right to waive or vary any of the procedures or standards set forth herein at its discretion, for good cause shown.

6.1.13 Commencement of Construction

Upon receipt of approval from the Design Review Committee, the Owner shall, as soon as practicable, satisfy all conditions thereof, if any, and diligently proceed with the commencement and completion of all construction, reconstruction, refinishing, alterations, and excavations pursuant to the approved plans, in accordance with the requirements of the Declaration of Covenants, Conditions, and Restrictions.

6.1.14 Design Review Committee Fees

The following fees and deposits are hereby established by the Design Review Committee. The fees and deposits may be changed from time to time without notice:

- The Owners will be charged a processing fee for each plan submittal to be established by the Design Review Committee.
- Buyers requesting a meeting with the Design Review Committee prior to close of escrow on a Lot will be required to pay a fee of \$250 per meeting request, payable to the *Foothills Partners* at the time of the meeting. Upon close of escrow and at the time of the PreDesign Conference, pre-escrow design meeting fees will be credited to the Lot Owner. However, if the Buyer cancels escrow, pre-escrow design meeting fees are non-refundable.

- Effective April 2004 a non-refundable fee of \$1,500.00 for graded lots and \$2,500.00 for natural lots, made payable to the *Foothills Partners*, is required in advance of a Lot Owner's PreDesign Conference.
- If a Lot Owner and/or his/her designated representative is unable to attend their PreDesign Conference, they must notify the DRC seventy-two (72) *business* hours in advance of the PreDesign Conference, otherwise a \$250.00 Cancellation Fee will be assessed and said fee must be paid in advance of rescheduling their PreDesign Conference for another date, [effective April 2004].
- Significant Modification to an Existing Design: a non-refundable fee of \$1,500.00, payable to the *Foothills Partners*, is due upon submittal of the revised plan(s) [effective April 2004].
- Multi-Plan Submittal: a non-refundable review fee of \$1,500.00 per plan, payable to the *Foothills Partners*, is required to process the Schematic Plan Design Packages [effective April 2004].
- The Owner or the Contractor shall provide a cash deposit in the amount of \$5,000.00 payable to the *Foothills Partners* at the time of submittal for final design approval. This deposit will be fully refunded without interest upon completion of all Improvements, including landscaping and acceptance by the Design Review Committee, provided there is no damage caused by the Owner or his contractor to any public or private Improvements, common areas, or other Lots or Parcels within the community. Any such damage will require repair by the Owner at the Owner's expense. Failure to do so will cause MacDonald Highlands Master Association to perform such services and charge applicant for said work.



The Design Review Committee must be notified by the Owner at the time of initial movement of equipment on the site prior to commencement of work on the site. The Owner must notify the Design Review Committee of completion of the project and apply for a refund of the deposit.



6.2 **MERCHANT-BUILT RESIDENTIAL DEVELOPMENT PROCEDURES**

6.2.1 **Submission of Plans**

Plans and specifications shall be submitted to the Design Review Committee in accordance with the following submittal and review procedures.

6.2.2 **Review of Plans**

The Design Review Committee shall conduct reviews of plans during PreDesign Conferences only. Owners, Architects, or Builders shall have the right to attend any PreDesign Conference of the Design Review Committee. To assure a thorough and complete review, Schematic and Final plan submittals will be reviewed by the Committee and/or their representatives outside of any Committee meetings. The Design Review Committee will respond in writing within fifteen (15) working days after the review (but not later than thirty (30) days after a submittal is completed), provided that the plans are in accordance with the requirements outlined. Any responses an Owner may wish to make in reference to issues contained in the Design Review Committee's notice following review of submitted plans must be addressed to the Design Review Committee in writing. In addition, all approvals as required by the City of Henderson must be obtained after the Design Review Committee-approval and prior to the commencement of construction.

6.2.3 PreDesign Conference

After the close of a lot or parcel, and prior to completing a Building design, it is *mandatory* that the Owner and/or his professional consultants meet with the Design Review Committee to review the Design Guidelines and Standards and the Owner's proposed design.

At this meeting, the Owner will be expected to outline the project to the Design Review Committee in terms of its land use, building size (i.e., site plan), building mass arrangements (i.e., exterior elevations), type of project, materials, and proposed construction schedule. Should the Design Review Committee deem it necessary, subsequent PreDesign Conferences may be required.

Effective April 2004 a non-refundable fee of \$1,500.00 for graded lots and \$2,500.00 for natural lots, made payable to the *Foothills Partners*, is required in advance of a Lot Owner's PreDesign Conference. Multi-Plan Submittals require a non-refundable review fee of \$1,500.00 per plan, payable to the *Foothills Partners*.

If a Lot Owner and/or his/her designated representative is unable to attend their PreDesign Conference, they must notify the DRC seventy-two (72) *business* hours in advance of the PreDesign Conference, otherwise a \$250.00 Cancellation Fee will be assessed and said fee must be paid in advance of rescheduling their PreDesign Conference for another date [effective April 2004].

6.2.4 Concept Plan Review

The Concept Plan Review allows the applicant the opportunity to introduce his concepts for the design, character, and extent of development of the subject site to the Design Review Committee. The Design Review Committee and the Developer can discuss the proposed project and concepts in relation to their applicability to MacDonald Highlands' Community Design Standards. The purpose of the Concept Plan Review is to give the applicant and the Design Review Committee the opportunity to exchange ideas and to provide the applicant with a direction with which to proceed.

The submittal package for the Concept Plan Review should include the following items as a minimum:

- One 24" x 36" blueline copy of the Site Plan drawn to scale and with dimensions.
- One 8-1/2" x 11" clear film transparency of the Site Plan. Note: Clear film transparencies shall have black continuous lines and legible notes, and dimensions, which provide a crisp, clean copy when duplicating.
- The Site Plan should include the following information as a minimum:
 - Vicinity map.
 - North arrow and scale (NLT 1" = 60').
 - Gross area, number of lots/units, lot size, density.
 - Parcel description.

- Name, address, and telephone number of owner, engineer, architect, land planner, and applicant.
 - Proposed lots, buildings, structures, improvements.
 - Samples must be presented within a three-ring binder, clearly marked with Builder's name, filing date, and Parcel number. All samples must be identified with manufacturer's names, color and number, and manufacturer cut-sheets for ALL exterior materials (i.e., windows, glass block, skylights, roof top windows, Solatubes®, solar panels, flat roof surface material & color, railings, wrought iron gates, doors (typical), front doors, patio doors, garage doors, landscape lighting, exterior wall-mounted light fixtures, exterior recessed lighting; driveway, walkway, terrace, balcony and patio materials & colors; address identification device, etc.) are required within the concept plan review submittal package.
 - Buildings: Elevations of Buildings from all sides at an appropriate scale sufficient to clearly indicate the design concepts, placements, and massing of buildings.
 - Gross and net Building square footage.
 - Heights of all Improvements.
 - Number of levels or floors.
 - Windows, doors, balconies, and other structural openings.
 - Existing topography.
 - Proposed grades and elevations.
 - Adjacent property, structures, improvements, landscaping, to a minimum distance of 25 feet beyond the subject site property lines.

- Amenities, open space, landscape areas, entries and features, lighting, and proposed signage features and location.
 - Setbacks (Front, Side, and Rear Yards).
 - Walls.
 - Proposed parking areas and number of spaces.
 - Drainage facilities.
 - Trash collection/container locations.
 - Service and delivery locations and travel routes.
 - Driveways, curb cuts.
 - Utilities plan.
 - Location of plant, equipment, and storage buildings and rooms.
 - Proposed fire lanes.
-
- Floor Plan(s)

 - Roof Plan(s)

 - Color Blocking Exhibits for all elevations *are required* with the schematic plan submittal package. Please be advised renderings are not required; the Design Review Committee requires exhibits identifying the application of all proposed colors and materials. This can be accomplished in many ways, for example, call outs on elevations or color-coded elevations.

 - Proposed product floor plans and elevations.

 - Landscaping concepts/treatments with proposed planting palette and landscape lighting and fixtures

 - Edge treatment concepts between the project and adjacent properties.

6.2.5 Grading Plan Review

The purpose of the Grading Plan Review is to insure that the grading concepts for the proposed project are consistent with MacDonald Highlands' Community Development Standards and that the end result will be compatible with adjacent property, improvements, hillsides, open space, homes, developments, etc.

The submittal package for the Grading Plan Review should include the following items as a minimum:

- One 24" x 36" blueline copy of the proposed Grading Plan drawn to scale and with dimensions
- The Grading Plan should include the following information as a minimum:
 - Existing topography.
 - Proposed grades and elevations.
 - All retaining walls, structures, devices, or concepts and their heights (top-of-wall and bottom-of-footing).
 - Natural slopes.
 - Manufactured slopes or scarps.
 - Drainage swales, improvements, facilities.
 - Impact on adjacent property, improvements, structures, open space, etc. to a distance of 25 feet beyond the subject site's property lines.
 - Soils report.
 - Drainage study.

6.2.6 Tentative Map Review

The purpose of the Tentative Map Review is to insure that the tentative map that will be submitted to the City of Henderson is in compliance with approvals and conditions resulting from the previous reviews of the Concept Plan and the Grading Plan.

The submittal package to the Design Review Committee for the Tentative Map Review should be the same as will be submitted to the City of Henderson, including:

- An approximate time schedule indicating starting and completion dates of construction, utility hook-up, completion of landscaping work, and anticipated occupancy Date.
- Location, size, finished floor elevation of Building(s).
- Existing and proposed contours.
- Right-of-Way Lines of existing and proposed Streets and sidewalks immediately adjoining and within the proposed Lot or Parcel, and the names of all proposed Streets.
- All exterior elevations with both existing and proposed grades shown.
- Finalized Material Sample Binder Selections and Manufacturer Cut Sheets (where applicable)
- Modified Color Blocking Exhibits (where applicable)

- Location, dimension, and proposed use of all paved areas and driveways.
- Location of fire hydrants.
- Location of on-site utility and mechanical equipment such as transformers, solar panels, air conditioning, electrical equipment, water meters, etc.
- Location of all Building entrances.
- Water supply plan.
- A grading plan showing existing and finished grades and proposed methods of handling storm runoff from roof and paved areas.
- Lighting Plan, including catalogue cuts and mounting devices for all exterior fixtures (submit samples of all fixtures to be utilized).
- Signage Plan, with detailed drawings showing the proposed design of all exterior Signs, including:
 - All Sign copy.
 - True Sign colors including lettering and background materials (submit samples).
 - Dimensions of Sign.
 - Sign materials.
 - Method of illumination.
 - Sign mounting methods.
 - Sign area (square feet).
 - Location on Lot, Parcel, or Building (scaled drawing).
 - Letter style.

- Landscape Plan showing square footage, location, size, quantity, type of all trees and vegetation, and turf and indicating:
 - Grading plan, including berms and swales.
 - Irrigation plan.
 - Screening, walls, fences.
 - Outdoor eating areas.
 - Recreation areas.
 - Water features.
 - Pedestrian paths.
 - Art.
 - Hardscape.
 - Foundations.
 - Furniture/Fixtures
 - Landscape Lighting/Fixtures

- Such other reasonable information as may be required by the Design Review Committee.

6.2.7 Final Map Review

The purpose of the Final Map Review is to insure that the Final Map that will be submitted to the City of Henderson for approval and recordation is in compliance with previous approvals for the subject site granted by the Design Review Committee.

The submittal package to the Design Review Committee for the Final Map Review should be the same as will be submitted to the City of Henderson.

6.2.8 Improvement Plan Review

The purpose of the Improvement Plan Review is to insure that those concepts presented and approved through the Concept Plan Review, Grading Plan Review, and Tentative Map Review are incorporated into the engineering plans for the subject site.

The submittal package for the Improvement Plan Review should be one set of the proposed improvement plans.

6.2.9 Revisions

Any changes to the approved plans before, during, or after the construction of an Improvement must first be submitted to the Design Review Committee for approval. All submittals shall be accompanied by a cover letter, letter of transmittal or a copy of the Design Review Committee's "Application for an Alternation and/or Modification to an Existing Structure or Lot" describing the revisions proposed.

6.2.10 Resubmittal of Plans

In the event of any disapproval by the Design Review Committee of either a preliminary or a final submission, a resubmission of plans should follow the same procedure as an original submittal. An additional Design Review Fee shall accompany each such resubmission as required by the Design Review Committee.

6.2.11 Working Drawings and Construction Specifications

Prior to plan approval, a Pre-Construction Conference *is required* for final plan approval by the Design Review Committee. The Lot Owner or a designated representative for the Lot Owner shall schedule an appointment with a MacDonald Highlands representative to discuss forthcoming construction activities on the Lot, prior to the issuance of the Design Review Committee approval letter to the City of Henderson. As a reminder, all approvals must be obtained from the Design Review Committee prior to submittal to the City of Henderson. The requirement to schedule a Pre-Construction Conference does not constitute plan approval by the Design Review Committee.

Upon Final Plan approval from the Design Review Committee, the Owner will be responsible for submitting their Site Plan drawings, Construction Working Plans, and specifications to the appropriate City of Henderson Departments, Commissions, and Council (if required) for their review and approval as to conform with the City Zoning Ordinance, and local and State Building Safety Codes and in accordance with their review process. Upon approval of the Plan and specifications by the City, a construction permit should be issued.

Original construction working plans must be submitted to the Design Review Committee so that they may be stamped as approved by the Design Review Committee prior to any submittals to the City of Henderson. Any drawings submitted to The City of Henderson without this approval stamp will be rejected.

6.2.12 Work in Progress

The Design Review Committee may inspect all work in progress and give notice of non-compliance. Absence of such inspection and notification during the construction period does not constitute either approval of the Design Review Committee with work in progress or compliance with these Design Development Guidelines and Standards or the Declaration.

6.2.13 Completed Work

Upon completion of any Residence, Building, Structure, or other Improvement for which final approval was given by the Design Review Committee, the Owner shall be given written notice of completion by the Design Review Committee.

Within such reasonable time as the Design Review Committee may determine, but in no case exceeding ten (10) days from receipt of such written notice of completion from the Owner, or the Owner's duly authorized representative, it may inspect the Residence, Building, Structure, and/or Improvements. If it is found that such work was not done in strict compliance with the final plan approved by the Design Review Committee, it shall notify the Owner in writing of such non-compliance within five (5) days after the inspection, specifying in reasonable detail the particulars of non-compliance, and shall require the Owner to remedy the same.

6.2.14 Right of Waiver

The Design Review Committee reserves the right to waive or vary any of the procedures or standards set forth herein at its discretion, for good cause shown.

6.2.15 Commencement of Construction

Upon receipt of approval from the Design Review Committee, the Owner shall, as soon as practicable, satisfy all conditions thereof, if any, and diligently proceed with the commencement and completion of all construction, reconstruction, refinishing, alterations, and excavations pursuant to the approved plans, in accordance with the requirements of the Declaration of Covenants, Conditions, and Restrictions.

6.2.16 Design Review Committee Fees

The following fees and deposits are hereby established by the Design Review Committee. The fees and deposits may be changed from time to time without notice:

- The Owners will be charged a processing fee for each plan submittal to be established by the Design Review Committee.
- Buyers requesting a meeting with the Design Review Committee prior to close of escrow on a Lot will be required to pay a fee of \$250 per meeting request, payable to the *Foothills Partners* at the time of the meeting. Upon close of escrow and at the time of the PreDesign Conference, pre-escrow design meeting fees will be credited to the Lot Owner. However, if the

Buyer cancels escrow, pre-escrow design meeting fees are non-refundable.

- Effective April 2004 a non-refundable fee of \$1,500.00 for graded lots and \$2,500.00 for natural lots, made payable to the *Foothills Partners*, is required in advance of a Lot Owner's PreDesign Conference.
- If a Lot Owner and/or his/her designated representative is unable to attend their PreDesign Conference, they must notify the DRC seventy-two (72) *business* hours in advance of the PreDesign Conference, otherwise a \$250.00 Cancellation Fee will be assessed and said fee must be paid in advance of rescheduling their PreDesign Conference for another date [effective April 2004].
- Significant Modification to an Existing Design: a non-refundable fee of \$1,500.00, payable to the *Foothills Partners*, is due upon submittal of the revised plan(s) [effective April 2004].
- Multi-Plan Submittal: a non-refundable review fee of \$1,500.00 per plan, payable to the *Foothills Partners*, is required to process the Schematic Plan Design Packages [effective April 2004].
- The Owner or the Contractor shall provide a cash deposit in the amount of \$5,000.00 payable to the *Foothills Partners* at the time of submittal for final design approval. This deposit will be fully refunded without interest upon completion of all Improvements, including landscaping and acceptance by the Design Review Committee, provided there is no damage caused by the Owner or his contractor to any public or private

Improvements, common areas, or other Lots or Parcels within the community. Any such damage will require repair by the Owner at the Owner's expense. Failure to do so will cause MacDonald Highlands Master Association to perform such services and charge applicant for said work.

The Design Review Committee must be notified by the Owner at the time of initial movement of equipment on the site prior to commencement of work on the site. The Owner must notify the Design Review Committee of completion of the project and apply for a refund of the deposit.

6.3 PROCEDURES FOR COMMERCIAL/RESORT DEVELOPMENTS

6.3.1 Submission of Plans

Plans and specifications shall be submitted to the Design Review Committee in accordance with the following submittal and review procedures.

6.3.2 Review of Plans

The Design Review Committee shall conduct reviews of plans during PreDesign Conferences only. Owners, Architects, or Builders shall have the right to attend any PreDesign Conference of the Design Review Committee. To assure a thorough and complete review, Schematic and Final plan submittals will be reviewed by the Committee and/or their representatives outside of any Committee meetings. The Design Review Committee will respond in writing within fifteen (15) working days after the review (but not later than thirty (30) days after a submittal is completed), provided that the plans are in accordance with the requirements outlined. Results of reviews will not be discussed over the telephone by members of the Design Review Committee with an Owner, or his Architect or Builder. Any responses an Owner may wish to make in reference to issues contained in the Design Review Committee's notice following review of submitted plans must be addressed to the Design Review Committee in writing. In addition, all approvals as required by the City of Henderson must be obtained after the Design Review Committee-approval and prior to the commencement of construction.

6.3.3. PreDesign Conference

After the close of a lot or parcel, and prior to completing a Building design, it is *mandatory* that the Owner and/or his professional consultants meet with the Design Review Committee to review the Design Guidelines and Standards and the Owner's proposed design.

At this meeting, the Owner will be expected to outline the project to the Design Review Committee in terms of its land use, Building size (i.e., site plan), Building mass arrangements (i.e., exterior elevations), type of project, materials, and proposed construction schedule. Should the Design Review Committee deem it necessary, subsequent PreDesign Conferences may be required.

Effective April 2004 a non-refundable fee of \$1,500.00 for graded lots and \$2,500.00 for natural lots, made payable to the *Foothills Partners*, is required *in advance* of a Lot Owner's PreDesign Conference. Multi-Plan Submittals require a non-refundable review fee of \$1,500.00 per plan, payable to the *Foothills Partners*.

If a Lot Owner and/or his/her designated representative is unable to attend their PreDesign Conference, they must notify the DRC seventy-two (72) *business* hours in advance of the PreDesign Conference, otherwise a \$250.00 Cancellation Fee will be assessed and said fee must be paid *in advance* of rescheduling their PreDesign Conference for another date [effective April 2004].

6.3.4 Preliminary Site Plan Review

The Preliminary Site Plan Review allows the applicant the opportunity to introduce his concepts for the design, character, and extent of development of the subject site to the Design Review Committee. The Design Review Committee and the developer can discuss the proposed project and concepts in relation to their applicability to MacDonald Highlands' Community Design Standards. The purpose of the Community Design Standards is to give the applicant and the Design Review Committee the opportunity to exchange ideas and to provide the applicant with a direction with which to proceed.

The submittal package for the Preliminary Site Plan Review should include the following items as a minimum:

- One 24" x 36" blue-line copy of a Preliminary Site Plan drawn to scale and with dimensions.
 - Vicinity map.
 - North arrow and scale (NLT 1" = 60').
 - Gross area, number of lots/units, lot size, density.
 - Parcel description.
 - Name, address, and telephone number of owner, engineer, architect, land planner, and applicant.
 - Adjacent property, structures, improvements, landscaping, to a minimum distance of 25 feet beyond the property lines of the subject site.
 - Amenities, open space, landscape areas, entries and features, and proposed signage features and location.
 - Setbacks (front, side, rear).
 - Drainage facilities.

- Location of plant, equipment, and storage buildings and rooms.
 - Proposed fire lanes.
 - Landscaping concepts/treatments with proposed planting palette.
 - Edge treatment concepts between commercial/resort property and adjacent property.
 - Floor Area Ratio.
-
- Proposed product floor plans and elevations.
-
- Site coverage ratio (defined as the Building ground contact area divided by the total gross Lot or Parcel area).
-
- Location of all other Improvements, walls, outside storage areas.
-
- Alleys, adjacent Streets with all existing/future Rights-Of-Ways, curb, and Property Line.
-
- Driveways, curb cuts.
-
- Configuration of parking and vehicular circulation including employee, handicapped and visitor parking.
-
- Dimensions for Parking Stalls, Parking Aisles, and landscaped Islands.
-
- Total parking provided.
-
- Calculation demonstrating total parking required.

- Truck service and loading areas, including proposed screening.
- Refuse enclosure areas, including proposed screening for other than single family residential.
- Existing topography.
- Conceptual grading (proposed grades and elevations), drainage, lighting, and utilities Plan.
- Buildings: Elevations of Buildings from all sides at an appropriate scale sufficient to clearly indicate the design concepts, placement, and massing of buildings. The following Improvement details shall also be provided:
 - Scale not less than 1/4" = 1'.
 - Gross and net Building square footage.
 - Heights of all Improvements.
 - Number of levels or floors.
 - Windows, doors, balconies, and other structural openings.
 - Existing and proposed grade lines.
 - Samples must be presented within a three-ring binder, clearly marked with Builder's name, filing date, and Parcel number. All samples must be identified with manufacturer's names, color and number, and manufacturer cut-sheets for **ALL** exterior materials (i.e., windows, glass block, skylights, roof top windows, Solatubes®, solar panels, flat roof surface material & color, railings, wrought iron gates, doors (typical), front doors, patio doors, garage doors, landscape lighting, exterior wall-mounted light fixtures, exterior recessed lighting; driveway, walkway, terrace,

balcony and patio materials & colors; address identification device, etc.) are required within the preliminary site plan submittal package.

- Floor Plan(s)
- Roof Plan
- Color Blocking Exhibits for all elevations are required with the schematic plan submittal package. Please be advised renderings are not required; the Design Review Committee requires exhibits identifying the application of all proposed colors and materials. This can be accomplished in many ways, for example, call outs on elevations or color-coded elevations.
- Signs: Exterior Signs Plan showing proposed location of all Building-mounted Signs, directional Signs, information Signs, and ground-mounted Signs.
- Landscaping: A conceptual landscape Plan should indicate:
 - Square footage of Landscape Area in Front, Side, and Rear Yards.
 - Square footage of Landscape Area in Parking Area for Non-Residential Buildings.
 - Location and species of existing vegetation.
 - Conceptual landscape design.
 - Landscape lighting / fixtures

6.3.5 Grading Plan Review

The purpose of the Grading Plan Review is to insure that the grading concepts for the proposed project are consistent with MacDonald Highlands' Community Development Standards and that the end result will be compatible with adjacent property, improvements, hillsides, open space, homes, developments, etc.

The submittal package for the Grading Plan Review should include the following items as a minimum:

- One 24" x 36" blueline copy of the proposed Grading Plan drawn to scale and with dimensions.
- The Grading Plan should include the following information as a minimum:
 - Existing topography.
 - Proposed grades and elevations
 - All retaining walls, structures, devices, or concepts and their heights (top-of-wall and bottom-of-footing).
 - Natural slopes.
 - Manufactured slopes or scarps.
 - Drainage swales, improvements, facilities.
 - Impact on adjacent property, improvements, structures, open space, etc., to a distance of 25 feet beyond the subject site's property lines.
- Soils report.
- Drainage study.

6.3.6 Tentative Commercial Subdivision Map Review

The purpose of the Tentative Commercial Subdivision Map Review is to insure that if a tentative map is submitted to the City of Henderson, it is in compliance with approvals and conditions resulting from the previous reviews of the Concept Plan and the Grading Plan.

The submittal package to the Design Review Committee for the Tentative Map Review should be the same as will be submitted to the City of Henderson.

6.3.7 Final Site Plan Review

The Final Site Plan Review allows the applicant to present the entire project exactly as it is intended to be constructed to the Design Review Committee for review. The purpose of this review is to insure that the project as submitted for the Final Site Plan Review is in compliance with previous reviews and approvals and is in compliance with MacDonald Highlands' Community Development Standards before the applicant goes forward with final maps or final improvement plans.

The submittal package to the Design Review Committee for the Final Site Plan Review should include all of the items that were required for the Preliminary Site Plan except that they should be shown on the Final Site Plan in the exact shape, size, and location they are to be constructed with detailed dimensions. In addition to the above the Final Site Plan will also include the following:

The site plan will state the project area, building square footage, amount of building coverage, amount of parking spaces, and amount of landscaped area.

- Detailed landscaping plans showing planting materials, types, and locations, and landscape lighting and fixtures.
- An approximate time schedule indicating starting and completion dates of construction, utility hook-up, completion of landscaping work and anticipated occupancy Date.
- Location, size, finished floor elevation of Building(s).
- Existing and proposed contours.
- Finalized Material Sample Binder Selections and Manufacturer Cut Sheets (where applicable)
- Modified Color Blocking Exhibits (where applicable)
- Right-of-Way Lines of existing and proposed Streets and sidewalks immediately adjoining and within the proposed Lot or parcel, and the names of all proposed Streets.
- All exterior elevations with both existing and proposed grades shown.
- Location of curb cuts for Lots or Parcels.
- Location of all curb cuts of adjacent Lots or Parcels.
- Location, dimension, and proposed use of all paved areas, and Driveways.



- Information for fire department, indicating type of roof construction and where sprinklers and smoke detectors are to be provided.
- Location of fire hydrants.
- Location of on-site utility and mechanical equipment such as transformers, solar panels, air conditioning, satellite dishes, electrical equipment, water meters, etc.
- Location of all Building entrances.
- Water supply plan.
- Sewage load estimate and disposal plan.
- A grading plan showing existing and finished Grades and proposed methods of handling storm runoff from roof and paved areas.
- Storm drainage calculations by a person licensed to design a storm drainage system.
- Lighting Plan, including catalogue cuts and mounting devices for all exterior fixtures (submit samples of all fixtures to be utilized).
- A report detailing the operation relative to environmental questions of noise, odor, glare, vibration, smoke, dust, ashes, radiation, hazardous or noxious wastes, and any other factors requested by the Declaration or Design Development Guidelines and Standards.



- Signage Plan, with detailed drawings showing the proposed design of all exterior Signs, including:
 - All Sign copy.
 - True Sign colors including lettering and background materials (submit samples).
 - Dimensions of Sign.
 - Sign materials.
 - Method of illumination.
 - Sign mounting methods.
 - Sign area (square feet).
 - Location on Lot, Parcel, or Building (scaled drawing).
 - Letter style.

- Landscape Plan showing square footage, location, size, quantity, type of all trees and vegetation, and turf and indicating:
 - Grading plan, including berms and swales.
 - Irrigation plan.
 - Screening, walls, fences.
 - Outdoor eating areas.
 - Recreation areas.
 - Water features.
 - Pedestrian paths.
 - Art.
 - Hardscape.
 - Foundations.
 - Furniture/Fixtures.
 - Landscape Lighting/Fixtures

- Such other reasonable information as may be required by the Design Review Committee.

6.3.8 Final Commercial Subdivision Map Review

The purpose of the Final Commercial Subdivision Map Review is to insure that if a Final Map is submitted to the City of Henderson for approval and recordation, it is in compliance with previous approvals for the subject site granted by the Design Review Committee.

The submittal package to the Design Review Committee for the Final Map Review should be the same as will be submitted to the City of Henderson.

6.3.9 Improvement Plan Review

The purpose of the Improvement Plan Review is to insure that those concepts presented and approved through the Concept Plan Review, Grading Plan Review, Tentative Map Review, and Final Site Plan Review are incorporated into the engineering plans for the subject site.

The submittal package for the Improvement Plan Review should be one set of the proposed improvement plans.

6.3.10 Revisions

Any changes to the approved plans before, during, or after the construction of an Improvement must first be submitted to the Design Review Committee for approval. All submittals shall be accompanied by a cover letter, letter of transmittal or a copy of the Design Review Committee's "Application for an Alternation and/or Modification to an Existing Structure or Lot" describing the revisions proposed.

6.3.11 Resubmittal of Plans

In the event of any disapproval by the Design Review Committee of either a preliminary or a final submission, a resubmission of plans should follow the same procedure as an original submittal. An additional Design Review Fee shall accompany each such resubmission as required by the Design Review Committee.

6.3.12 Working Drawings and Construction Specifications

Prior to plan approval, a Pre-Construction Conference *is required* for final plan approval by the Design Review Committee. The Lot Owner or a designated representative for the Lot Owner shall schedule an appointment with a MacDonald Highlands representative to discuss forthcoming construction activities on the Lot, prior to the issuance of the Design Review Committee approval letter to the City of Henderson. As a reminder, all approvals must be obtained from the Design Review Committee prior to submittal to the City of Henderson. The requirement to schedule a Pre-Construction Conference does not constitute plan approval by the Design Review Committee.

Upon Final Plan approval from the Design Review Committee, the Owner will be responsible for submitting their Site Plan drawings, Construction Working Plans, and specifications to the appropriate City of Henderson Departments, Commissions, and Council (if required) for their review and approval as to conform with the City Zoning Ordinance, and local and State Building Safety Codes and in accordance with their review process. Upon approval of the Plan and specifications by the City, a construction permit should be issued.

Original construction working plans must be submitted to the Design Review Committee so that they may be stamped as approved by the Design Review Committee prior to any submittals to the City of Henderson. Any drawings submitted to The City of Henderson without this approval stamp will be rejected.

6.3.13 Work in Progress

The Design Review Committee may inspect all work in progress and give notice of non-compliance. Absence of such inspection and notification during the construction period does not constitute either approval of the Design Review Committee with work in progress or compliance with these Design Development Guidelines and Standards or the Declaration.

6.3.14 Completed Work

Upon completion of any Residence, Building, Structure, or other Improvement for which final approval was given by the Design Review Committee, the Owner shall be given written notice of completion by the Design Review Committee.

Within such reasonable time as the Design Review Committee may determine, but in no case exceeding ten (10) days from receipt of such written notice of completion from the Owner, or the Owner's duly authorized representative, it may inspect the Residence, Building, Structure, and/or Improvements. If it is found that such work was not done in strict compliance with the final plan approved by the Design Review Committee, it shall notify the Owner in writing of such non-compliance within five

(5) days after the inspection, specifying in reasonable detail the particulars of non-compliance, and shall require the Owner to remedy the same.

6.3.15 Right of Waiver

The Design Review Committee reserves the right to waive or vary any of the procedures or standards set forth herein at its discretion, for good cause shown.

6.3.16 Commencement of Construction

Upon receipt of approval from the Design Review Committee, the Owner shall, as soon as practicable, satisfy all conditions thereof, if any, and diligently proceed with the commencement and completion of all construction, reconstruction, refinishing, alterations, and excavations pursuant to the approved plans, in accordance with the requirements of the Declaration of Covenants, Conditions, and Restrictions.

6.3.17 Design Review Committee Fees

The following fees and deposits are hereby established by the Design Review Committee. The fees and deposits may be changed from time to time without notice:

- The Owners will be charged a processing fee for each plan submittal to be established by the Design Review Committee.
- Buyers requesting a meeting with the Design Review Committee prior to close of escrow on a Lot will be required to pay a fee of \$250 per meeting request, payable to the *Foothills Partners* at the time of the

meeting. Upon close of escrow and at the time of the PreDesign Conference, pre-escrow design meeting fees will be credited to the Lot Owner. However, if the Buyer cancels escrow, pre-escrow design meeting fees are non-refundable.

- Effective April 2004 a non-refundable fee of \$1,500.00 for graded lots and \$2,500.00 for natural lots, made payable to the *Foothills Partners*, is required *in advance* of a Lot Owner's PreDesign Conference.
- If a Lot Owner and/or his/her designated representative is unable to attend their PreDesign Conference, they must notify the DRC seventy-two (72) *business* hours in advance of the PreDesign Conference, otherwise a \$250.00 Cancellation Fee will be assessed and said fee must be paid *in advance* of rescheduling their PreDesign Conference for another date [effective April 2004].
- Significant Modification to an Existing Design: a non-refundable fee of \$1,500.00, payable to the *Foothills Partners*, is due upon submittal of the revised plan(s) [effective April 2004].
- Multi-Plan Submittal: a non-refundable review fee of \$1,500.00 per plan, payable to the *Foothills Partners*, is required to process the Schematic Plan Design Packages [effective April 2004].
- The Owner or the Contractor shall provide a cash deposit in the amount of \$5,000.00 payable to the *Foothills Partners* at the time of submittal for final design approval. This deposit will be fully refunded without interest upon completion of all Improvements,

including landscaping and acceptance by the Design Review Committee, provided there is no damage caused by the Owner or his contractor to any public or private Improvements, common areas, or other Lots or Parcels within the community. Any such damage will require repair by the Owner at the Owner's expense. Failure to do so will cause MacDonald Highlands Master Association to perform such services and charge applicant for said work.

The Design Review Committee must be notified by the Owner at the time of initial movement of equipment on the site prior to commencement of work on the site. The Owner must notify the Design Review Committee of completion of the project and apply for a refund of the deposit.

6.4 DESIGN REVIEW COMMITTEE

The Design Review Committee shall consist of a minimum of three members to a maximum of five members total. Each of said persons shall hold his/her office until such time as he/she has resigned or been removed or his/her successor has been appointed as set forth herein or in the Declaration.

6.4.1 Appointment of Members

Except as herein below provided, the right from time to time to appoint and remove all members of the Design Review Committee shall be, and is hereby, reserved to and vested solely in Declarant.

The right from time to time to appoint and remove members of the Design Review Committee shall be reserved to and vested in the Association as follows:

From and after January 1, 1998, the Association shall have the right to appoint and remove one member of the Design Review Committee.

From and after January 1, 1999, the Association shall have the right to appoint and remove two members of the Design Review Committee.

From and after January 1, 2004, the Association shall have the right to appoint and remove all members of the Design Review Committee;

Provided, however, that if Declarant fails to exercise its rights of appointment as herein above provided or records an instrument waiving such rights, the Association shall thereupon and thereafter have the right to appoint and remove all members of the Design Review Committee.

6.4.2 Resignation of Members

Any member of the Design Review Committee may at any time resign from the Design Review Committee upon written notice delivered to Declarant or to the Association, whichever then has the right to appoint and remove members.

6.4.3 Duties

It shall be the duty of the Design Review Committee to consider and act upon such proposals or plans from time to time submitted to it pursuant to the Design Guidelines, to perform such other duties from time to time delegated to it by the Declaration or the Association, and to amend the Design Guidelines when, and in the manner, deemed appropriate or necessary by the Design Review Committee.

6.4.4 Meetings

The Design Review Committee shall meet from time to time as necessary to properly perform its duties hereunder. The vote or written consent of a majority of the members shall constitute an act by the Design Review Committee unless the unanimous decision of its members is otherwise required by the Declaration or these Design Guidelines. The Design Review Committee shall keep and maintain a record of all action from time to time taken by the Design Review Committee at such meetings or otherwise.

Effective *April 2002*, the MacDonald Highlands Design Review Committee (“Design Review Committee”) will meet *biweekly* to review approval applications and to conduct prescheduled PreDesign Conferences with Lot Owners. The Design Review Committee shall conduct

reviews of plans during prearranged PreDesign Conferences *only*. However, to assure a thorough and complete review, schematic, final and subsequent plan submittals will continue to be reviewed *administratively* by the Design Review Committee outside the biweekly Design Review Committee meeting.

6.4.5 Design Review Architectural Representation

The DRC anticipates employing the services of an Architect or Designer to review submitted plans for conformance to the Design Guidelines. From time to time during the design review process, an Owner and/or his representative may meet or communicate informally with the DRC representative. While it is the intent of these informal meetings to provide direction to the Owner, any comments or suggestions made are done solely to provide direction and they do not represent any official approval or disapproval by the DRC.

6.4.6 Compensation

Unless authorized by the Association, the members of the Design Review Committee shall not receive any compensation for services rendered. All members shall be entitled to reimbursement for reasonable expenses incurred by them in connection with the performance of any Design Review Committee function or duty. Professional consultants retained by the Design Review Committee shall be paid such compensation as the Design Review Committee determines.

6.4.7 Amendment of Design Guidelines

The Design Review Committee may, from time to time and in its sole discretion, adopt, amend, and repeal by unanimous vote, rules, and regulations to be incorporated into, or amendments of the Design Guidelines, which, among other things, interpret, supplement, or implement the provisions of the Design Guidelines. All such rules and regulations or amendments, as they may from time to time be adopted, amended, or repealed, shall be appended to and made a part of the Design Guidelines and shall thereupon have the same force and effect as if they were set forth in and were a part of the Declaration. *Each Owner is responsible for obtaining from the Design Review Committee a copy of the most recently revised Design Guidelines before commencing on any improvements to the Owner's Lot.*

Minor amendments, administrative in nature, may be made by the Design Review Committee and may be approved administratively by the City of Henderson (Development Code/Henderson, Nevada, Section 19.2.7.D.2). Policy changes may be made unilaterally by the Design Review Committee with notification to City of Henderson staff.

Changes of a substantial nature may be recommended by the Design Review Committee for consideration by the Declarant and/or Board of Directors of the Association. Any request for substantial amendments that increases the number of dwelling units, decreases the amount of common open space, alters a road pattern, changes the type structures, increases the size of proposed structures to be constructed or requests new waivers of code requirements *shall be approved by the City of Henderson* (Development Code/Henderson, Nevada, Section 19.2.7.D.1).

6.4.8 Non-Liability

Neither the Design Review Committee nor any member thereof shall be liable to the Association or to any owner or other Person for any damage, loss, or prejudice suffered or claimed on account of (a) the approval or disapproval of any plans, drawings, and specifications, whether or not defective, (b) the construction or performance of any work, whether or not pursuant to approved plans, drawings, and specifications, (c) the development, or manner of development of any property within MacDonald Highlands, or (d) the execution and filing of an estoppel certificate whether or not the facts therein are correct; provided, however, that such member has, with the actual knowledge possessed by him, acted in good faith. Without in any way limiting the generality of the foregoing, the Design Review Committee, or any member thereof, may, but is not required to, consult with or hear the Association or any Owner or other Person with respect to any plans, drawings, or specification, or any other proposal submitted to the Design Review Committee.

6.4.9 Non-Liability of the Design Review Committee and Declarant

Neither the Design Review Committee, any member thereof, nor the Declarant or their respective successors or assigns shall be liable in damages to anyone submitting plans to them for approval, or to any Owner or other Person by reason of mistake in judgment, negligence, or nonfeasance arising out of or in connection with the approval or disapproval or failure to approve any plans and specifications. *Every Owner or other Person who submits plans to the Design Review Committee for approval agrees, by submission of such plans and specifications, that he will not bring any action or suit*

against the Design Review Committee, any member thereof, or Declarant to recover damages. Approval by the Design Review Committee, any member thereof, or the Declarant shall not be deemed to be a representation or warranty that the Owner's plans or specifications or the actual construction of a Residence or other Improvement comply with applicable governmental ordinances or regulations, including but not limited to zoning ordinances and local building codes. It shall be the sole responsibility of the Owner or other Person submitting plans to the Design Review Committee or performing any construction to comply therewith.

6.4.10 Enforcement

These Design Guidelines may be enforced by the Design Review Committee, the Association, or Declarant as provided herein or in the Declaration.

6.4.11 Severability

If any provision of these Design Guidelines, or any section, clause, sentence, phrase or work, or application thereof in any circumstance, is held invalid, the validity of the remainder of these Design Guidelines, and of the application of any such provision, section, sentence, clause, phrase or work in any other circumstance, shall not be affected thereby, and the remainder of these Design Guidelines shall be construed as if such invalid part were never included therein.

6.5 CONSTRUCTION CONTROL

In order to assure that the natural desert landscape of each Lot is not damaged during any construction activities, the following construction regulations shall be enforced during the construction period. These regulations shall be made a part of the construction contract document specifications for each Residence or other Improvements on a Lot and all Builders, Owners, and other Persons shall be bound by these regulations. Any violation by a Builder shall be deemed to be a violation by the Owner of the Lot.

6.5.1 Pre-Construction Conference: Prior to Design Review Committee-plan approval for plans check submittal to the City of Henderson, the Builder must meet with a representative of the Design Review Committee to review construction procedures and coordinate his activities in MacDonald Highlands.

6.5.2 Construction Conditions

Prior to the commencement of any construction activity on a Lot, the Owner and Builder shall provide a detailed plan as to the manner in which conditions will be protected, and the areas in which all construction activity will be confined to, including, but not limited to: size and location for construction material storage, limits of excavation, drive areas, parking, chemical toilet location, temporary Structures, if any, dumpsters, storage of debris, fire extinguisher, utility trenching, and Dust Control sign. All construction activities, materials, and equipment must be kept in the cleanest of conditions and in a manner appropriate to the overall integrity of MacDonald Highlands.

6.5.3 Commencement of Construction

Upon written receipt of final approval from the Design Review Committee, and having satisfied the City of Henderson, Nevada review process, the Owner shall post a completion bond, construction loan documentation or other Design Review Committee-approved guarantee providing sufficient coverage to finish the exterior appearance of the home including exterior building and site Improvements.

The Owner shall satisfy conditions and commence the construction of any work pursuant to the approved plans within one year from the date of such approval. If the Owner fails to begin construction within this time period, any approval given shall be deemed revoked unless, upon the written request of the Owner made to the Design Review Committee prior to the expiration of said twelve-month period and upon a finding by the Design Review Committee that there has been no change in circumstances, the time for such commencement is extended in writing by the Design Review Committee.

It will be considered that construction has commenced once a City permit has been issued and the Lot has been disturbed. Construction must proceed in a continuous manner through the completion of the Residence. If construction ceases for a period greater than 45 days, the Design Review Committee may require that either construction immediately resumes or the Lot is returned to its pre-existing condition. The Builder's Deposit may be forfeited if either alternative is not achieved within 45 days of written notice to the Owner by the Design Review Committee.

The Owner shall, in any event, complete construction of any Improvement on his Lot within eighteen (18) months after commencing construction thereof, except and for so long as such completion is rendered impossible or would result in great hardship to the Owner due to labor strikes, fires, national emergencies or natural calamities.

If the Owner fails to comply with this schedule, the Design Review Committee shall have the right (but no obligation) to either have the exterior of the Improvement completed in accordance with the approved plans or remove the Improvements, with all expenses incurred to be reimbursed to the Design Review Committee by the Owner.

6.5.4 Inspection of Work in Progress

The Design Review Committee may inspect all work in progress and give notice of noncompliance. Absence of such inspection or notification during the construction period does not constitute an approval by the Design Review Committee of work in process or compliance with these Design Guidelines.

Construction documentation required of each Lot Owner, Developer and/or Builder is as follows:

- i. **PRIOR TO** pouring the slab the builder or owner must submit a wet stamped letter from a Nevada registered land surveyor attesting that the **main level** slab form elevations match the elevations submitted. If the owner does not comply the Developer will have it performed and deduct the cost from the construction deposit.

- ii. **AFTER** the **main level** slab is poured, the owner or builder must submit an 8.5" x 11" plot plan "as-built" of the home showing actual distances from corners to property lines in tenths of a foot and wet stamped by a Nevada registered land surveyor. If the owner does not comply the Developer will have it performed and deduct the cost from the construction deposit.
- iii. **AFTER** top-out, the builder or owner must submit a wet stamped letter from a Nevada registered land surveyor ~~stating the vertical difference between the highest roof peak and the top of curb at the center of the lot certifying the highest roof peak elevation.~~ If the owner does not comply the Developer will have it performed and deduct the cost from the construction deposit.

Of course, pertinent grading and building construction inspections by the City of Henderson are required to confirm U.B.C. and City of Henderson zoning, ordinance and building standards.

6.5.5 Temporary Construction Fencing

The main concept of MacDonald Highlands is to preserve the natural characteristics of the terrain during the development of the community. In order to accomplish this, it is necessary for us to adopt grading criteria, which limits the amount of discretionary grading that can be performed.

Any grading and all associated disturbances of the natural desert done for the purpose of constructing an individual residence on a lot or for the purpose of making improvements to an existing residence will be confined within the area designated as the Building Envelope for

that particular lot. Therefore, the Owner shall stake all property lines and install a temporary construction fence along the property lines of a Graded Lot or along the Building Envelope on a Natural Lot before going vertical or framing begins so that all construction activity remains within the building limits of the lot. Lots along the golf course require temporary construction fencing along the property lines adjacent to the course **prior to** occupying the lot (i.e., grading operations). **Temporary construction fencing must remain onsite until the completion of all permanent property line fences and/or walls and landscape installation.**

6.5.6 Subsequent Changes

Additional construction or other Improvements to a Residence or Lot, or changes during construction or after completion of an approved structure, must be submitted to the Design Review Committee for approval prior to making changes or additions. All submittals shall be accompanied by a cover letter, letter of transmittal or a copy of the Design Review Committee's "Application for an Alternation and/or Modification to an Existing Structure or Lot" describing the revisions proposed.

6.5.7 Final Inspection of the Improvements

Upon completion of any Residence or other Improvement, and prior to occupancy, the Owner shall give written notice of completion (See Exhibit C—Application for Project Completion Review) to the Design Review Committee. Within 10 days of such notification, a representative of the Design Review Committee may inspect the Residence or other Improvements for compliance. If all Improvements comply with these Design Guidelines, the Design Review

Committee will issue a written approval to the Owner, constituting a final release of the Improvements by the Design Review Committee, said release to be issued within 10 days of the final inspection. If it is found that the work was not done in strict compliance with the approved plans or any portion of these Design Guidelines, the Design Review Committee may issue a written notice of noncompliance to the Owner, specifying the particulars of noncompliance, said notice to be issued within 10 days of the final inspection. The Owner shall have 30 days from the date of notice of noncompliance within which to remedy the noncompliance portions of his Improvement. The Owner may request additional time; however, the maximum extension permitted is sixty (60) days from the date of the initial inspection. However, if an extension is not granted, and the Owner has failed to remedy the noncompliance, the Design Review Committee may take action to remove, at the Owner's cost, the non-complying Improvements as provided for in these Design Guidelines, including, without limitation, injunctive relief or the imposition of a fine.

If, after receipt of written notice of completion from the Owner, the Design Review Committee fails to notify the Owner of any failure to comply within 60 days following the Design Review Committee's inspection, the Improvements shall be deemed in accordance with the final plan. If a notice of approval is made by the Design Review Committee, any unused portion of the builder deposit will be refunded within thirty (30) days after approval.

6.5.8 Occupational Safety and Health Act (OSHA) Compliance: All applicable OSHA regulations and guidelines must be strictly observed at all times.

- 6.5.9 Construction Trailers, Portable Field Offices, Etc.:** ~~Effective December 2005~~, small ~~8' x 10'~~ trailers are permitted (mini-mobiles ~~are preferred~~) and must be located behind the temporary construction fencing; only one (1) trailer per construction site is allowed. Larger-size trailers may be considered on a case-by-case basis by the Design Review Committee and are subject to approval by the Design Review Committee prior to delivery and jobsite placement.
- 6.5.10 Storage Containers:** one (1) roll-off type storage container is permitted per jobsite and must be located behind the temporary construction fencing. Storage containers must be removed within fifteen (15) days after the Certificate of Occupancy is issued by the City of Henderson, Nevada.
- 6.5.11 Debris and Trash Removal:** a covered dumpster is required before going vertical or framing begins and must remain onsite throughout the construction of the residence and installation of all site improvements, including landscaping. **Manmade enclosures, cages and onsite trash piles are not allowed!** Dumpsters must be covered during non-working hours. Extra precaution must be taken when a dumpster is placed in the roadway. Orange safety cones shall surround the dumpsters at a safe distance to caution pedestrians and oncoming vehicular traffic of the unexpected obstacle in the roadway ahead.

Owners and Builders shall clean up all trash and debris on the construction site at the end of each day and roadways shall remain clear and free of materials and debris at all times. Trash and debris shall be removed from each construction site at least once a week to a dumping site located off the project. Lightweight material, packaging,

and other items shall be placed in a covered dumpster to prevent wind from blowing such materials off the construction site. Owners and Builders are prohibited from dumping, burying, or burning trash anywhere on the Lot or in MacDonald Highlands. During the construction period, each construction site shall be kept neat and shall be properly policed to prevent it from becoming a public eyesore, or affecting other Lots and any open space. Any clean-up costs incurred by the Design Review Committee or the Association in enforcing these requirements will be billed to the Owner. Dirt, mud, or debris resulting from activity on each construction site shall be promptly removed from public or private roads, open spaces, and driveways or other portions of MacDonald Highlands.

As standard practice, and in efforts to maintain a professional, quality controlled environment within MacDonald Highlands, all construction sites and roadways will be cleaned on every Friday afternoon by the Owner/Builder. Failure to clean the construction site and surrounding roadway(s) weekly may result in an expense to the Owner/Builder. Violators will be notified in writing, via facsimile and registered mail, and required to rectify the situation within a specified timeframe. Each Owner/Builder shall control his/her contractors and the actions of said contractors. All liability for violations of the Design Guidelines caused by a subcontractor(s) shall rest with the Owner/Builder. If an Owner/Builder fails to comply within this time period, the Design Review Committee may enter the Lot and correct the violation at the Owner/Builder's expense. Any such expense shall be secured by applying a back-charge to Owner/Builder's construction deposit. Should the construction deposit be depleted for excessive infringements, the Declarant has the

right to place a *lien* upon the Lot enforceable in accordance with the Declaration.

On each construction site, the Builder must designate a wash-out area within the Lot for contractors and suppliers to clean their equipment. The cleaning of equipment must occur, and cleaning effluent must remain, within that specified area. Equipment cleaned in any area other than the designated area will result in the Design Review Committee imposing a fine or retaining the Builder's construction deposit to repair any damages resulting from such equipment cleaning in improper areas.

6.5.12 Sanitary Facilities: Each Owner and Builder shall be responsible for providing adequate sanitary facilities for his/her construction workers. Portable toilets or similar temporary toilet facilities shall be located on the site itself or outside the temporary construction fencing, behind the curb. All sanitary facilities must be anchored or secured to prevent turn over; **this is an environmental safety issue.**

6.5.13 Vehicles and Parking Areas: Construction crews will not park on, or otherwise use, other Lots or any open space. Because of City of Henderson Fire Code, on-street parking is limited to one side of the street only. The approved street parking is limited to the southside and the eastside of the street only (*per MacDonald Highlands Master Association Rules and Regulations adopted July 10, 2002*). All vehicles will be parked so as not to inhibit traffic, and within the designated areas so as not to damage the natural landscape.

6.5.14 Staging Areas

Effective May 2002 all construction activity, including all improvements, location of material storage, debris, dumpsters and temporary facilities are to be contained

within the limits of the Lot under construction; no exceptions.

If a private agreement is made between neighboring lot owners, the lot owners must advise the DRC, *in writing*, of said agreement. The lot owner requesting the use of another lot for staging will be required to install temporary construction fencing on the staging lot, as well as his/her lot under construction.

- 6.5.15 Conservation of Landscaping Materials:** Owners and Builders are advised of the fact that the Lots and open spaces contain valuable native plants and other natural landscaping materials that should be absolutely protected during construction, including topsoil, rock outcroppings and boulders, and plant materials.

Materials that cannot be removed should be marked and protected by flagging, fencing, or barriers. The Design Review Committee shall have the right to flag major terrain features or plants that are to be fenced off for protection. Any trees or branches removed during construction must be promptly cleaned up and removed immediately from the construction site.

- 6.5.16 Excavation Materials:** Excess excavation and any spoil materials must be hauled away from MacDonald Highlands to a legitimate disposal site. Dumping of excess or spoil materials within the MacDonald Highlands community shall result in a fine and an assessment for the proper disposal site. Stockpiling of excavation and spoil materials, when permitted by the Design Review Committee, requires a dust control permit, issued by the Clark County-Department of Air Quality Management.

- 6.5.17 Blasting:** If any blasting is to occur, the Design Review Committee must be informed far enough in advance to allow it to make such investigation as it deems appropriate to confirm that all appropriate measures, including protective actions, have been taken prior to the blasting. No blasting or impact digging causing seismic vibrations may be undertaken without the approval of the Design Review Committee. Applicable governmental regulations should also be reviewed prior to any blasting activity.
- 6.5.18 Restoration or Repair of Other Property Damaged:** Damage and scarring to other property, including, but not limited to, open space, other Lots, roads, driveways, and/or other Improvements will not be permitted. If any such damage occurs, it must be repaired and/or restored promptly at the expense of the Person causing the damage or the Owner of the Lot within sixty (60) days. Upon completion of construction, each Owner and Builder shall clean his construction site and repair all property which was damaged, including but not limited to restoring grades, planting shrubs and trees as approved or required by the Design Review Committee, and repair of streets, driveways, pathways, drains, culverts, ditches, signs, lighting, and fencing.
- 6.5.19 Miscellaneous and General Practices:** All Owners will be absolutely responsible for the conduct and behavior of their agents, representatives, Builders, contractors, and subcontractors on MacDonald Highlands. The following practices are prohibited on MacDonald Highlands:
- Changing oil on any vehicle or equipment anywhere within MacDonald Highlands.

- Allowing concrete suppliers and contractors to clean their equipment on the site other than the Owner/Builder's lot.
- With the exception of the Building Envelope, removing any rocks, plant material, topsoil, or similar items from any property of others within MacDonald Highlands, including construction sites, unless it is from the site under construction and only then with prior approval from the Design Review Committee.
- Carrying any type of firearms within MacDonald Highlands.
- Using disposal methods or units other than those approved by the Design Review Committee.
- Careless disposition of cigarettes and other flammable material. At least one 10-pound ABC-rated dry chemical fire extinguisher shall be present and available in a conspicuous place on the construction site at all times.
- Careless treatment or removal of any desert plant materials not previously approved by the Design Review Committee.
- Use or transit over the golf course area.
- Consumption of alcoholic beverages within MacDonald Highlands.
- No pets, particularly dogs, may be brought onto any site under construction. No pets will be allowed to roam at will throughout MacDonald Highlands. In the event of any violation hereof, the Design Review Committee, the Association, or Declarant shall have the right to contact the City of Henderson or Clark County authorities to

impound the pets, or to refuse to permit such Builder or subcontractor to continue work on MacDonald Highlands property, or to take such other action as may be permitted by law, the Design Guidelines, or the Declaration.

- Catering trucks will not be permitted. Also, trash generated from construction practices must be contained and disposed of properly in covered trash receptacles.
- Music is limited to the interior of a residence and, in no case, may intrude on the privacy of the community.

6.5.20 Construction Area Plan: Prior to the commencement of any construction activity on a Lot, the Owner and Builder shall provide a detailed plan as to the manner in which the natural desert will be protected, and the areas to which all construction activity will be confined to, including: size and location for construction material storage, limits of excavation, drive areas, parking, chemical toilet location, temporary structures, if any, dumpsters, storage of debris, fire extinguisher, utility trenching, and Dust Control signage. This plan should identify the methods for protection, such as fencing, flagging, rope, barricades, or other means, to be set up prior to commencement of construction.

- 6.5.21 Construction Access:** The only approved construction access during the time a Residence or other Improvements are being built will be over the approved driveway for the Lot unless the Design Review Committee approves an alternative access point. If the construction activity crosses an existing curb and gutter, an asphalt ramp with a 4-inch sleeve for drainage must be installed prior to use. The ramp shall not extend more than 2 feet from the curb face

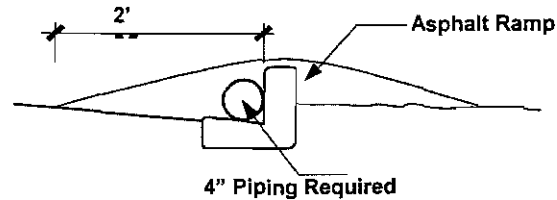

Construction Access Detail
N.T.S.

into the roadway.

- 6.5.22 Dust and Noise:** The Contractor shall be responsible for controlling dust and noise from the construction site in compliance with applicable government regulations and MacDonald Highlands grading standards. Lot Owners/ Contractors are required to obtain the necessary Dust Control permit from the Clark County Health District. Stockpiling of excavation and spoil materials, when permitted by the Design Review Committee, requires a dust control permit, issued by the Clark County- Department of Air Quality Management.

6.5.23 Signage: Dust Control signs are required for a Lot or Parcel greater than .25-acres and are to be constructed per Clark County-Department of Air Quality Management specifications. Builder signs and/or any other form of construction signage may **not** be attached to dust control signs. No other signage, including but not limited to marketing signs, "For Sale" signs, construction signs, contractor/sub-contractor signs, etc., is permitted in the community.

6.5.24 Daily Operation: Daily working hours for each construction site shall be between the hours of 6:00AM and 6:00PM, Monday through Friday, and between 9:00AM and 5:00PM on Saturday. Construction or maintenance activity is not permitted on Sundays and designated holidays without written approval from the Master Homeowners Association.

All construction-related entry and exits to the project and/or individual construction jobsites are to be through the Stephanie Street gate only.

Construction equipment will not be permitted on the property after hours. If construction activities proceed beyond standard daily operation hours, the equipment will be required to remain onsite until the Stephanie Street construction gate is reopened in the morning. **NO CONSTRUCTION TRAFFIC WILL BE PERMITTED TO EXIT THROUGH THE MAIN GATE.**

6.5.25 Enforcement: If an Owner, Builder or Developer violates any construction control provision contained in Section 6.5 of these Design Guidelines, the Owner, Builder or Developer will be notified, in writing, via facsimile and/or certified mail, of such violation and the Owner, Builder or Developer shall be required to remedy the violation within a specified timeframe established by the Declarant.

If an Owner, Builder or Developer fails to remedy the violation within the established timeframe, the Declarant may take action to rectify the violation itself and reimburse itself for the cost associated with the effort by deducting the incurred costs from the Owner's, Builder's or Developer's construction deposit, as provided for in these Design Guidelines, including, without limitation, injunctive relief and/or the imposition of a fine. If the Owner's, Builder's or Developer's construction deposit is depleted by incurred costs, the Declarant has the right to place a lien upon the property and deny future access to the jobsite until all uncollected fees, costs and fines are paid and the jobsite is brought into full compliance.

Exhibit A - Application for Schematic Plan Review

Date _____ Lot # _____

Owner _____

Address _____

Phone _____

Signature _____

Design professional _____

Address _____

Phone _____

Builder _____

Address _____

Phone _____



**MACDONALD
HIGHLANDS**

**Design Review
Committee**

This application will be considered complete only if all the documents and submittals, as set forth in the Design Guidelines are included. One (1) set of all documents is required.

For Reviewer Use Only:

Submittal date _____

Review date _____

Notice To Owner:

Following your Preliminary Submittal, the DRC:

- Approves your Preliminary Plan
- Approves your Preliminary Plan, with the following conditions:

- Disapproves your Preliminary Plan for the following reasons and requires a revised submittal:

Signed _____

Note: Approval and compliance with conditions is a pre-condition to filing an application for Final Submittal.



SCHEMATIC PLAN REVIEW CHECKLIST

The Schematic Plan submittal is required to give an indication of the design, character and extent of the proposed immediate development. The Schematic Plan is to be submitted and approved prior to Final Plan submittal. Please refer to Section 6 of the Design Guidelines for detailed instructions.

- o One (1) complete set of plans drawn to scale and fully dimensions
- o One (1) each of **ALL** drawings **reduced to 8½ x 11” format**
- o General:
 - o Owner’s name, address and telephone number
 - o Name, address and telephone number of the firm(s) preparing the plans
 - o Lot designation
 - o Scale
 - o North arrow
 - o Date plans were completed/updated
 - o Legal description of gross lot area; and
 - o Date of submission.
- o Site or Subdivision Plan:
 - o Scale: Site Plan not less than 1” = 20’; Subdivision Plat, when applicable, not less than 1” = 100’
 - o Survey prepared by a licensed surveyor or civil engineer
 - o Existing and proposed grade lines
 - o Square footage of lot, building, parking lot/drives and landscape/open space areas
 - o Site coverage ratio
 - o Front, side and rear yard setback lines
 - o Location of all other improvement walls, outside storage areas
 - o Alleys, adjacent streets, with all existing/ future rights-of-ways, curb, property line
 - o Driveways and curb cuts
 - o Total parking provided
 - o Conceptual grading, drainage, lighting and utilities plan
- o Lot Cross Sections— if applicable (reference Exhibit “V” of the Design Guidelines)
- o Buildings:
 - o Elevations of buildings from all sides
 - o Gross and net building square footage
 - o Heights of all improvements
 - o Number of levels or floors
 - o Windows, doors, balconies and other structural openings

Continued...

- o Exterior Materials Samples presented **within a three-ring binder** indicating all exterior materials, textures and colors...including windows, glass block, skylights, roof top windows, Solatubes®, solar panels, flat roof surface material & color, railings, wrought iron gates, doors, front doors, patio doors, garage doors, landscape light fixtures, exterior wall-mounted light fixtures, exterior recessed light fixtures; driveway, walkway, terrace, balcony and patio materials & colors; address identification device, etc.
- o Color Blocking Exhibits (i.e., four-sided colored elevations of each building)...please be advised renderings are not required; the DRC requires exhibits identifying the application of all proposed colors and materials.
- o Floor Plan(s)
- o Roof Plan
- o Mechanical, Plumbing and Electrical Plans (including Electrical Load Calculations)
- o Nevada Power Company Approval Letter (if applicable)
- o City of Henderson Variance Approval (if applicable)
- o Landscaping:
 - o Square footage of landscape area in front, side and rear yards
 - o Location and species of existing vegetation
 - o Conceptual landscape design
 - o Identify all paving and plant materials
 - o Identify locations for all landscape light fixtures proposed

NOTE: per Section 6.1.2—Review of Plans of the *MacDonald Highlands community design guidelines*, to assure a thorough and complete review, schematic and final plan submittals will be reviewed by the Committee and/or their representatives *outside* of any committee meetings. The DRC will respond in writing to a submittal no later than fifteen (15) working days after receipt of a review package, but no later than thirty (30) working days after a submittal is complete, provided the plans meet the requirements of the design guidelines. Members of the DRC will not discuss results of the reviews over the telephone with any owner or their representatives. Furthermore, **all approvals as required by the City of Henderson must be obtained AFTER DRC-approval and prior to the commencement of construction.**

Exhibit B - Application for Final Plan Review

Date _____ Lot # _____

Owner _____

Address _____

Phone _____

Signature _____

Design professional _____

Address _____

Phone _____

Builder _____

Address _____

Phone _____

This application will be considered complete only if all the documents and submittals as set forth in the Design Guidelines are included. One (1) set of all documents is required.

For Reviewer Use Only:

Submittal date _____

Review date _____

Notice To Owner:

Following your Final Submittal, the DRC:

- Approves your Final Submittal
- Approves your Final Submittal, with the following conditions:

- Disapproves your Final Submittal for the following reasons and requires a revised submittal:

Signed _____

Note: Building Permits must be obtained from the local Governing Authority and copies filed with the DRC prior to commencement of construction. An Application of Project Completion Review must be filed with the DRC prior to occupancy.



**MACDONALD
HIGHLANDS**

**Design Review
Committee**



MACDONALD HIGHLANDS

FINAL PLAN REVIEW CHECKLIST

Final Plans are to be submitted and approved by the Design Review Committee (DRC) **BEFORE** submittal to the City of Henderson. Please note approval of the schematic plan package to proceed to final plan preparation and DRC-submittal **DOES NOT CONSTITUTE FINAL PLAN APPROVAL BY THE DRC**. Please refer to Section 6 of the Design Guidelines for detailed instructions.

- One (1) complete set of plans drawn to scale and fully dimensioned—all comments from the previous schematic plan submittal are to be fully addressed
- One (1) each of **ALL** drawings **reduced to 8½ x 11” format**
- Remaining Materials Sample Selections and Manufacturer Cut-Sheets – where applicable
- Modified Color Blocking Exhibits – where applicable
- Revised Mechanical, Plumbing and Electrical Plans – where applicable
- Revised Irrigation and Landscaping Plans – where applicable
- Pre-Construction/Pre-Approval Requirements, i.e., proposed construction schedule, construction deposit and pre-construction conference appointment
- AutoCAD disk with the building perimeter and grades of the finalized site plan
- Massing Model (upon DRC request) – a simple massing model may be required to three-dimensionally demonstrate how the building relates to the lot and adjacent properties – where applicable

NOTE: per Section 6.1.2—Review of Plans of the *MacDonald Highlands community design guidelines*, to assure a thorough and complete review, schematic and final plan submittals will be reviewed by the Committee and/or their representatives *outside* of any committee meetings. The DRC will respond in writing to a submittal no later than fifteen (15) working days after receipt of a review package, but no later than thirty (30) working days after a submittal is complete, provided the plans meet the requirements of the design guidelines. Members of the DRC will not discuss results of the reviews over the telephone with any owner or their representatives. Furthermore, **all approvals as required by the City of Henderson must be obtained AFTER DRC-approval and prior to the commencement of construction.**

Revised December 2005



Design Review
Committee

MACDONALD HIGHLANDS

Exhibit C - Application for Project Completion Review

Date _____

Unit # _____

Requested by _____

Phone _____

Owner _____

Phone _____

Design professional _____

Phone _____

Contractor _____

Phone _____

Date of final inspection _____

NOTICE TO OWNER:

Following your request for Project Completion Review, the DRC finds that your final building and site construction:

Conforms—based on the recent inspection of the property, all improvements were constructed and accepted according to the plans and specifications approved by the MacDonald Highlands Design Review Committee. As the Owner/Developer has successfully addressed all remaining construction requirements pertaining to his/her Sales Contract, development of the Lot is **complete** and **approved** by the DRC as of this date. This authorized exhibit serves a full and final acceptance and release of the aforementioned project.

Does not conform to the plans and specifications approved in your final submittal. The following corrections/additions are required: _____

Signed _____

Date _____

* * * * *

AS A REMINDER, if any design changes or modifications are made to the exterior of the residence or any element onsite in the future, such revisions must first be submitted to the *MacDonald Highlands Master Homeowners Association* for approval. Furthermore, no materials or improvements are to be installed or constructed without HOA approval. If any materials or improvements are found to be in violation or not consistent with the requirements of the Design Guidelines and CC&Rs, the Owner/Developer will be held liable and will be required to remove/rectify the item(s) at his/her expense.

Revised 11/02

DESIGN REVIEW COMMITTEE
Application for an Alteration and/or Modification
to an Existing Structure or Lot



MACDONALD
HIGHLANDS

DESIGN REVIEW
COMMITTEE

1730 W. Horizon Ridge Pkwy
Suite 100
Henderson, Nevada 89012
Attention: Paula Gibson
(702) 458-0001 Phone
(702) 458-5570 Facsimile

Date _____ Lot # _____ Subdivision _____

Owner _____

Mailing Address _____

Phone _____

Signature _____

Design professional _____

Address _____

Phone _____

Builder _____

Address _____

Phone _____

SUBMITTAL DESCRIPTION: _____

This application will be considered complete only if all the documents and submittals, as set forth in the Design Guidelines are included.

For Reviewer Use Only:

Submittal date _____

Review date _____

Notice To Owner:

Following your Preliminary Submittal, the DRC:

- Approves your Preliminary Plan
- Approves your Preliminary Plan, with the following conditions:

- Disapproves your Preliminary Plan for the following reasons and requires a revised submittal:

Signed _____



MACDONALD
HIGHLANDS

MEMORANDUM

TO: All Lot Owners, Developers, Builders and Contractors
SUBJECT: MacDonald Highlands Construction Regulations
DATE: Updated December 1, 2005

The following list of items is just a summarized list of our Construction Regulations. Its purposes were a summary of the regulations that we could hand out to field superintendents and foremen on the project site. As you are aware, the manual given to you at the time of purchase is two inches thick and has been lost or misplaced, and may have never gotten to the site as required. This Memorandum is intended for reference only and does not imply that you are in violation of the rules. Please check your construction site and see if you are complying. If you have not started you dream home, just make sure your contractor is aware of these requirements before starting.

1. Prior to pouring the main level slab, a wet-stamp Elevation Certification from a Nevada registered land surveyor is required before going vertical.
2. After the main level slab is poured, a wet-stamp "as-built" plot plan from a Nevada registered land surveyor is required.
3. After top-out, a wet-stamp Height Elevation Certification from a Nevada registered land surveyor is required.
4. A construction fence is required before going vertical or framing begins.
5. One (1) 8' x 20' (maximum) construction trailer and one (1) roll-off type storage container are allowed per jobsite and must be located behind the temporary construction fencing.
6. A **COVERED** dumpster is required on all construction sites and maybe located in the street in front of the lot. Streets are to remain clear and free of debris at all times and construction debris is required to be cleaned up daily; all trash materials must be placed in the dumpster. Dumpsters must be covered during non-working hours—**cages and onsite trash piles are not allowed.**
7. Portable toilets are required and may be located outside construction fencing and behind the curb. All portable toilets must be anchored or secured to prevent turn over; this is an environmental issue.
8. Parking is allowed on the street but only one side or the other, not both. Therefore, you must coordinate parking with other builders on the street to insure everyone is on the same side of the street. This is a Fire Department requirement as well.
9. There is no parking, staging or storage on other lots, without the owner of that lot's consent. If consent is given, all rules that apply to your lot will also apply to the lot or lots that you may use for staging (including temporary construction fencing).
10. A Health District Dust Control Permit Sign is required for a lot greater then .25 acres. **No other signs are permitted.**
11. Working hours are 6AM-6PM, Monday through Friday, and between 9AM-5PM on Saturday, with no work on Sundays or holidays.
12. All entry and exits to the project are to be through the Stephanie Street construction gate. Be sure your crews leave early enough to exit through the Stephanie gate.

Additional copies of the MacDonald Highlands Design Guidelines are available for purchase via the MacDonald Highlands Sales Office, Suite #100 at a cost of \$200 per copy, or you may come to our offices and review the full Design Guidelines as needed.

7.0 HILLSIDE DESIGN GUIDELINES

7.1 INTRODUCTION

This chapter of the MacDonald Highlands' Design Guidelines provides standards and specifications for those developments that are situated in hillside areas. These standards have been developed in cooperation with the City of Henderson for the purpose of insuring that the necessary services can be provided to residents in these areas while protecting the special characteristics of the hillsides. All development in the hillside areas shall comply with these development standards and criteria.

7.2 PURPOSE

These guidelines provide for specific standards for the development of hillsides by minimizing soil disturbance, protecting visual assets, and preserving the City's natural character. Hillside areas shall include all parcels or site-planning areas which contain slopes of ten percent (10%) or greater and serve to protect major outcrops, prominent knolls, major ridgelines and peaks, and other significant habitats. The Hillside Design Guidelines will establish requirements to assure compatibility with the various slope conditions in the hillside areas and will insure sensitive development, which reinforce the unique character of the City's hillsides.

7.3 DEFINITIONS

"Buildable Area" is that portion of the platted lot, excluding the required setbacks as established by the base zoning district and all designated undevelopable area or open space area.

"Contour" means a line drawn on a plan, which connects all points of equal elevation.

"**Contour Grading**" is a grading concept designed to result in earth forms that resemble natural terrain characteristics.

"**Cut and Fill**" is the excavating of earth material in one location and the depositing of it in an adjacent location.

"**Hillside**" means a parcel of land with an average rise and fall of ten percent (10%) or more.

"**Hilltop**" means the highest elevation at the crest of a hill.

"**Grading**" is the movement of earth for individual building foundations, driveways, local roads, and utility excavation that conforms closely to natural contours.

"**Level Building Site**" is that portion contained within the dimensioned buildable area to accommodate the main structure, required off-street parking, accessory structures, and drainage resulting from said improvements.

"**Mass Grading**" is the movement of large quantities of earth over large areas. Disruption of the on-site surface terrain is common.

"**Natural Drainage**" is water, which flows by gravity in channels by the surface topography of the earth prior to changes made by the efforts of man.

"**Natural Slope**" means a slope that is not man-made.

"**Ridge**" means an elongated crest or series of crests of a hill.

"**Scarring**" means a visible cut in a hillside or ridge in which earth has been removed or disturbed.

"**Slope**" is expressed as a ratio or percentage of the vertical distance (rise), or change in elevation, to the horizontal distance (run). The percent of any given slope is determined by dividing the rise by the run, multiplied by 100.

"**Transition Slope**" is a slope contained wholly within the building area used to transition from the grade of the level building site to the natural or engineered finished grade of the yard area.

7.4 HILLSIDE CLASSIFICATION TYPES

Flat land slopes from zero to less than ten percent (10%) pose no major restriction in terms of hillside development. Hillside development classifications are determined to identify landform types as follows:

7.4.1 Hillside: Slopes of 10 to 15 percent where roads shall be generally parallel to contours are classified as hillsides. In addition, building sites are to be oriented parallel to slopes.

7.4.2 Steep Hillside: Steep Hillsides are classified as slopes of 16 to 30 percent. Such slopes are somewhat limited in terms of access and the ability to grade level building sites. View opportunities and visual prominence shall be recognized.

7.4.3 Mountainous: Mountainous slopes are those slopes of 31 to 50 percent. Graded pads using 2:1 slopes will be used, due to streets and building sites being difficult to create.

7.4.4 Rugged Mountain: Slopes of 51 percent or greater describe the Rugged Mountain classification. Development is virtually not feasible without massive grading.

7.5 HILLSIDE DEVELOPMENT STANDARDS

The development standards for hillside areas shall apply to slopes of 10 percent or greater and shall be consistent to the base-zoning district provided that the following requirements shall govern in case of any conflicts.

7.5.1 Design Standards: The form, mass, and profile of the individual building shall be designed to blend with the natural slope and character of the hillsides.

- The preferred orientation of buildings shall be parallel to the natural slope in order to minimize the amount of cut and fill.
- Buildings shall be placed on a site so that the appearance of vertical mass and visual impact shall be reduced.
- The majority of roof slope(s) shall be predominately oriented in the same direction as the natural slope.
- Building materials and color schemes shall blend with the natural landscape. Contrasting color accents shall be kept to a minimum.
- Walls and fences may be used to define a buildable area, but shall not dominate a view and may be subject to the provisions stated in the City's Municipal Code.

7.5.2 Site Standards: No excavation or other earth disturbance of lots in hillside areas shall be permitted prior to the issuance of a grading permit from the City of Henderson.

- The maximum slope ratio for cut or fill slopes shall be 2:1. However, if a geological stability analysis proves that bedding conditions are favorable, steeper slopes may be permitted to minimize cut slopes.

- The angle of any transition slope shall be gradually adjusted to the angle of the natural slope.
- All distributed or graded slopes and exposed surfaces shall be treated with simulated desert varnish, or any other native desert enhancing materials and vegetation that will restore the slope to its natural appearance.
- Lot grading shall be limited to the boundaries of the buildable area, driveways and the usable rear yard area between the building and top or toe of slope.
- If terrace-grading techniques are used, the lot configuration shall have variable undulating slopes to create a natural appearance. Straight uniform lot configurations are prohibited.

7.5.3 Streets, Driveways, and Drainage: Streets, driveways, and drainage channels shall conform to the natural slope.

- Fire apparatus Access Roads shall comply with the provisions of the 1998 Uniform Fire Code, Division II and The City of Henderson Fire Department requirements. These roads include all streets both private and public, fire lanes, alleys, and shall include driveways when any approved route around the exterior of the building is more than 150 feet from a street or fire lane.
- The maximum grades for Fire Apparatus Access Roads shall not exceed 15 percent or as specified in The City of Henderson Hillside Guidelines. The total cumulative length of the access road in excess of 15 percent, but less than 18 percent, shall not exceed 300 linear feet.

- The maximum length of cul-de-sacs or dead-end streets shall be 900 feet with Henderson Fire Department approval. Each cul-de-sac or dead-end street beyond the maximum length shall be approved by City Council.
- Common area private driveways shall serve up to a maximum of five parcels as a method to reduce unnecessary grading, paving, and site disturbance. Driveways serving more than one parcel shall comply with the Fire Department access road requirements.
- Fire hydrants shall be located such that a clear area approximately 3' by 6' shall be centered on the fire hydrant. The 3' dimension shall be aligned with the 4" pumper nozzle cap and the 6' dimension aligned with 2-1/2" hose nozzle caps.
- The minimum private street width for one-way streets from flow line to flow line shall be 20 feet, in which parking is prohibited. The minimum private street width for two-way streets from flow line to flow line shall be 24 feet, in which parking is prohibited. The minimum private street width from flow line to flow line shall be 32 feet, in which parallel parking is permitted on one side. The minimum private street width from flow line to flow line shall be 40 feet, in which parallel parking is permitted on two sides.
- The use of ribbon curb or L-type curb shall be a minimum of 2 feet on each side of a street right-of-way and shall be approved by the Public Works Department.

- Sidewalks will be required on each side of a public street right-of-way.
- "No Parking" signs shall be installed when required by the Fire Department or the Public Works Department.
- Special streets such as split-level streets, dead-end streets, and minor variations from the maximum grade standards are prohibited, unless approved by the City Engineer and the Fire Department.
- Manufactured slopes adjacent to any street or driveway shall be given an appearance that resembles the natural slope and shall be treated with simulated desert varnish.
- Natural drainage features shall be incorporated into a project design to preserve the natural character of the hillsides.

7.6 HILLSIDE DEVELOPMENT APPLICATION

Planning Areas 7, 8B, 14, 16B, 18, 19A, 21, 22, 26, & 27

A development plan in hillside areas shall include the following items in addition to all standard development requirements of the Henderson Municipal Code, except as specified in Section 19.60 of the Henderson Hillside Regulations.

7.6.1 Hillside Development Plan: Upon a tentative map application, the following development plans shall indicate sufficient topographic data that displays the nature of the natural terrain.

- A site plan indicating proposed uses, buildable area, building locations, density, open space, and slope analysis that indicates the percentages of natural slope by land form type as specified in Section 19.60.006 of the Henderson Hillside Regulations.
- A circulation plan indicating traffic flow, pedestrian flow, width of streets, street grades, public or private streets, and parking areas.
- A preliminary grading plan indicating the nature and general extent of the proposed grading.

7.6.2 Hillside Development Reports: Upon a final map application, all geology and hydrology reports shall be compiled by a Nevada Registered Professional Engineer and shall be subject to City Engineer approval.

- A geology report including the surface and subsurface geology of the site, degree of seismic hazard, the effect of geologic conditions on the proposed development, adequacy of sites to be developed, and design criteria to mitigate any identified geologic hazards.



- A drainage report including the hydrologic conditions on the site, nuisance drainage, possible flood indentation and downstream flood hazards. The report shall account for all runoff and debris from tributary areas, include design criteria to mitigate any identified hydrologic hazards, and shall provide consideration for each lot in a proposed hillside development.
- Traffic Study for each sub-development that will be consistent with the master traffic study for MacDonald Highlands and define the participation costs for mitigation measures.

